

7% rabatt ska dras av på angivna priser



## H - Inredningsarmaturer

Lightyears

7%



# 7% rabatt ska dras av på angivna priser



## Våra kontor

### Borås

Olovsholmsgatan 25  
506 34 Borås

+46 (0)33 21 11 00  
boras@inputinterior.se

### Jönköping

Huskvarnavägen 64  
554 54 Jönköping

+46 (0)36 585 95 30  
jonkoping@inputinterior.se

### Kinna

Boråsvägen 17  
511 56 Kinna

+46 (0)320 20 90 30  
kinna@inputinterior.se

### Malmö

Flygplansgatan 9  
212 39 Malmö

+46 (0)40 20 66 00  
malmo@inputinterior.se

### Stockholm

Sveavägen 145  
113 46 Stockholm

+46 (0)8 517 112 00  
stockholm@inputinterior.se

### Västerås

Metallverksgatan 4B  
721 30 Västerås

+46 (0)21 80 30 30  
vasteras@efg.se

### Örebro

Radiatorvägen 2  
702 27 Örebro

+46 (0)19 767 35 80  
orebro@inputinterior.se

### Göteborg

Fältspatsgatan 2  
421 30 Västra Frölunda

+46 (0)31 799 89 00  
goteborg@inputinterior.se

### Kalmar

Engelska vägen 5  
392 39 Kalmar

+46 (0)480 578 00  
kalmar@inputinterior.se

### Kristianstad

Västra Storgatan 51K  
291 31 Kristianstad

+46 (0)44 785 08 40  
kristianstad@inputinterior.se

### Norrköping

Västgötegatan 13B  
602 21 Norrköping

+46 (0)11 440 94 00  
norrkoping@inputinterior.se

### Sundsvall

Strandgatan 14  
852 31 Sundsvall

+46 (0)60 52 50 10  
sundsvall@efg.se

### Växjö

Södra Vallviksvägen 10  
352 51 Växjö

+46 (0)470 79 37 00  
vaxjo@inputinterior.se

### Halmstad

Flygaregatan 8  
302 38 Halmstad

+46 (0)35 295 85 00  
halmstad@inputinterior.se

### Karlskrona

Blekingegatan 6A  
371 34 Karlskrona

+46 (0)455 68 88 20  
karlskrona@inputinterior.se

### Linköping

Gottorpsgatan 57  
581 19 Linköping

+46 (0)13 36 44 50  
linkoping@inputinterior.se

### Skellefteå

Brogatan 3  
931 62 Skellefteå

+46 (0)910 48 84 60  
skelleftea@inputinterior.se

### Uppsala

Sjukhusvägen 3  
753 09 Uppsala

+46 (0)18 430 53 04  
uppsala@inputinterior.se

### Helsingborg

Ekslingan 2  
254 67 Helsingborg

+46 (0)42 444 96 30  
helsingborg@inputinterior.se

### Karlstad

Blockgatan 10  
653 41 Karlstad

+46 (0)54 775 66 60  
karlstad@inputinterior.se

### Luleå

Bangårdsgatan 14  
972 75 Luleå

+46 (0)920 46 64 30  
lulea@inputinterior.se

### Skövde

Gustav Adolfs gata 31  
541 45 Skövde

+46 (0)500 77 93 80  
skovde@inputinterior.se

### Umeå

Björnvägen 19  
906 40 Umeå

+46 (0)90 34 00 160  
umea@inputinterior.se

## Input interiör i Norden

Se [inputinterior.se](http://inputinterior.se) för adresser och kontaktuppgifter till våra kontor i Danmark, Finland och Norge samt till alla våra medarbetare.

# 7% rabatt ska dras av på angivna priser

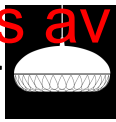

## AEON ROCKET™ MORTEN VOSS 2012

Aeon Rocket™ strikes a fine balance between a simple metal upper shade and a gauzy lower shade. The impression of lightness is created by hours and hours of meticulous manual work. 8 light bands made of recyclable polypropylene are carefully woven together into 100 and 98 round wopenings respectively, allowing the light to stream through unhindered.

### PENDANT

MODEL	COLOUR	CORD LGT. M	CORD SPECIFICATION	COLOUR CANOPY	PRODUCT CODE	DKK	SEK	NOK	GBP	EUR
P1	Aeon-Grey	3	Grey25, textile	White	14185212	3.075	3.982	4.037	369	415
P1	Aeon-Black	3	Grey85, textile	Black	14185008	3.075	3.982	4.037	369	415
P3	Aeon-Grey	6	Grey25, textile	White	14185912	4.177	5.410	5.483	502	564
P3	Aeon-Black	6	Grey85, textile	Black	14185508	4.177	5.410	5.483	502	564

PENDANT P1

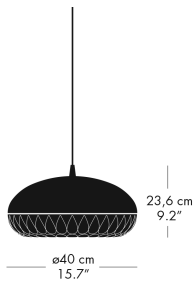

PENDANT P3

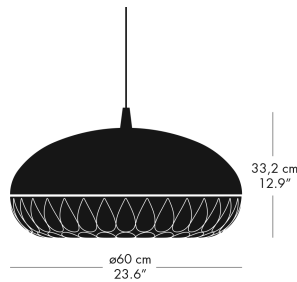

# 7% rabatt ska dras av på angivna priser



## AQ01™ ANNE QVIST 2017

The AQ01™ has curvy edges and matte finish. The shade can be switched on, off and dimmed directly at the top. The diffuser prevent glare and give off 100 percent direct downward illumination in a symmetric rotational pattern. The delicate arms connecting the two joints hide the wire within and keep it in place with an internal spring. The AQ01™ can be installed as a plug-in as desk-light, placed in a table or a wall base.

### AQ01

MODEL	COLOUR	CORD LGT. M	CORD SPECIFICATION	PRODUCT CODE	DKK	SEK	NOK	GBP	EUR
AQ01 - LED	White	2,5	White, PVC + adapter	62698505	2.118	2.743	2.780	254	286
AQ01 - LED	Black	2,5	Black, PVC + adapter	62698408	2.118	2.743	2.780	254	286
AQ01 - LED	Blue	2,5	Blue, PVC + adapter	62698606	2.118	2.743	2.780	254	286

### PLUG-IN

MODEL	COLOUR	CORD LGT. M	CORD SPECIFICATION	PRODUCT CODE	DKK	SEK	NOK	GBP	EUR
AQ01 + Plug-in	White	2,5	White, PVC + adapter	62716005	2.440	3.160	3.203	293	329
AQ01 + Plug-in	Black	2,5	Black, PVC + adapter	62716208	2.440	3.160	3.203	293	329
AQ01 + Plug-in	Blue	2,5	Blue, PVC + adapter	62716106	2.440	3.160	3.203	293	329

### TABLE

MODEL	COLOUR	CORD LGT. M	CORD SPECIFICATION	PRODUCT CODE	DKK	SEK	NOK	GBP	EUR
AQ01 + Tablebase	White	2,5	White, PVC + adapter	62699105	2.538	3.287	3.332	305	343
AQ01 + Tablebase	Black	2,5	Black, PVC + adapter	62699008	2.538	3.287	3.332	305	343
AQ01 + Tablebase	Blue	2,5	Blue, PVC + adapter	62699206	2.538	3.287	3.332	305	343

### WALL

MODEL	COLOUR	CORD LGT. M	CORD SPECIFICATION	PRODUCT CODE	DKK	SEK	NOK	GBP	EUR
AQ01 + Wallbase	White	2,5	White, PVC + adapter	62698805	2.297	2.975	3.015	276	310
AQ01 + Wallbase	Black	2,5	Black, PVC + adapter	62698708	2.297	2.975	3.015	276	310
AQ01 + Wallbase	Blue	2,5	Blue, PVC + adapter	62698906	2.297	2.975	3.015	276	310

### PLUG-IN

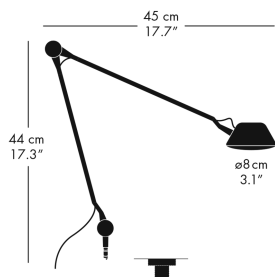

### TABLE

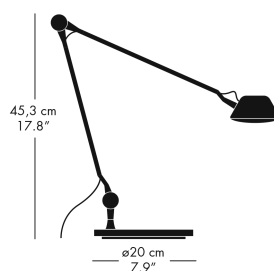

### WALL

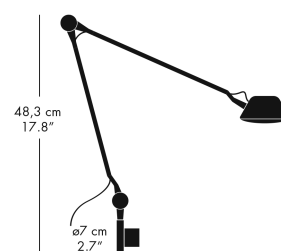

# 7% rabatt ska dras av på angivna priser



AVION™  
ISKOS-BERLIN 2012

A childhood fascination with Zeppelin airships gliding with steady grace across the sky, inspired Iskos-Berlin to create Avion™. The large, oval pendant hovers playfully in the air, ready to change its direction to suit your desire. The pendant emits a soft, diffuse light that creates a cosy, natural atmosphere. Avion™ can be arranged in a regular formation, as a dynamic pack or similarly it can be suspended in a line to mark a passage through a building.

## PENDANT

MODEL	COLOUR	CORD LGT. M	CORD SPECIFICATION	PRODUCT CODE	DKK	SEK	NOK	GBP	EUR
E27	Opal white	6	White, PVC	54402705	3.790	4.908	4.975	455	512
GX24q-4	Opal white	6	White, PVC	54402805	4.688	6.071	6.154	563	633
DAU	Opal white	6	White, PVC	54402905	4.688	6.071	6.154	563	633

## CANOPY

MODEL	COLOUR	PRODUCT CODE	DKK	SEK	NOK	GBP	EUR
Adjustable canopy	White	18615605	1.253	1.623	1.645	150	169

### PENDANT

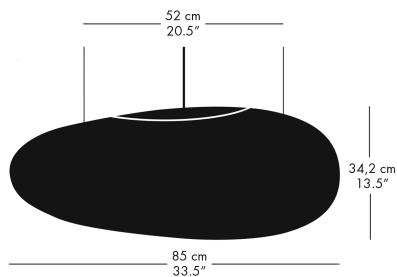

### ADJUSTABLE CANOPY



# 7% rabatt ska dras av på angivna priser

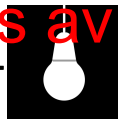

## BULB FICTION™

KIBISI 2012

Bulb Fiction™ is close to the classic incandescent bulb, but the shape has been upscaled and designed as a whole unit, uniting socket and bulb into one iconic shape. The same applies to the cord, which has been given extra volume using a thick, white silicone cover.

Bulb Fiction™ consists of a hand-blown acid-treated opal glass shade and an aluminium suspension with a soft, organic shape.

### PENDANT

MODEL	COLOUR	CORD LGT. M	CORD SPECIFICATION	COLOUR CANOPY	PRODUCT CODE	DKK	SEK	NOK	GBP	EUR
P1	White	3	White, PVC	White	24195505	994	1.287	1.305	119	134

### PENDANT P1

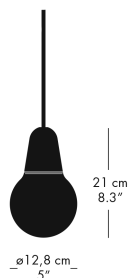

# 7% rabatt ska dras av på angivna priser



## CALABASH™ KOMPLOT DESIGN 2010

Calabash™ is authentic craftsmanship from the core to the surface. The organic design idiom and the specially chromed and slightly changeable surface provide Calabash™ with a unique expression. Every pendant goes through a comprehensive 4-step lacquering process, which is exclusively carried out by hand. The three pendant sizes present the same easily recognisable shape, although without being identical.

### PENDANT

MODEL	COLOUR	CORD LGT. M	CORD SPECIFICATION	COLOUR CANOPY	PRODUCT CODE	DKK	SEK	NOK	GBP	EUR
P1	Gold	3	Black, textile	Black	14017274	1.586	2.054	2.082	190	214
P1	Silver	3	Black, textile	Black	14017172	1.586	2.054	2.082	190	214
P2	Gold	3	Black, textile	Black	14018274	2.218	2.873	2.912	266	299
P2	Silver	3	Black, textile	Black	14018172	2.218	2.873	2.912	266	299
P3	Gold	6	Black, textile	Black	14023274	4.054	5.250	5.322	487	547
P3	Silver	6	Black, textile	Black	14023172	4.054	5.250	5.322	487	547

PENDANT P1

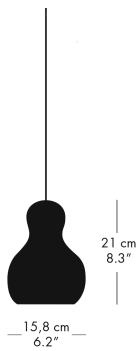

PENDANT P2

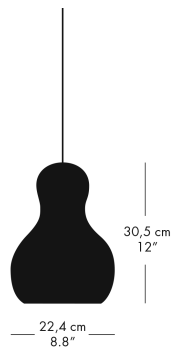

PENDANT P3

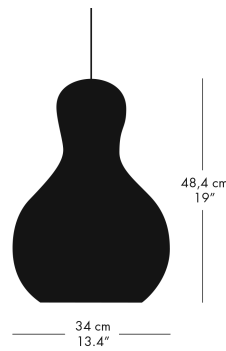



## CARAVAGGIO™ CECILIE MANZ 2005

The Caravaggio™ range of high-gloss pendants was launched in 2005 and instantly singled out as a design icon. The distinctive red cord and the polished surface, clearly highlight one of the most striking pendant designs of the 2000s. The praised Cecilie Manz design elegantly combines a recognisable shape with a modern expression.

### PENDANT

MODEL	COLOUR	CORD LGT. M	CORD SPECIFICATION	COLOUR CANOPY	PRODUCT CODE	DKK	SEK	NOK	GBP	EUR
P0	White	3	Grey, textile	White	74006605	1.046	1.355	1.373	126	141
P0	Black	3	Red, textile	White	74006508	1.046	1.355	1.373	126	141
P0	Blackblack	3	Black, textile	Black	54007508	1.046	1.355	1.373	126	141
P1	White	3	Grey, textile	White	54006905	1.494	1.935	1.961	179	202
P1	Black	3	Red, textile	White	54006708	1.494	1.935	1.961	179	202
P1	Blackblack	3	Black, textile	Black	54007608	1.494	1.935	1.961	179	202
P2	White	3	Grey, textile	White	54007005	2.086	2.702	2.738	251	282
P2	Black	3	Red, textile	White	54006808	2.086	2.702	2.738	251	282
P2	Blackblack	3	Black, textile	Black	54007708	2.086	2.702	2.738	251	282
P3	White	6	Grey, textile	White	74009705	3.800	4.921	4.988	456	513
P3	Black	6	Red, textile	White	74009608	3.800	4.921	4.988	456	513
P3	Blackblack	6	Black, textile	Black	54020208	3.800	4.921	4.988	456	513
P4 - E27	White	6	Grey, textile	White	54008705	4.770	6.178	6.262	573	644
P4 - E27	Black	6	Red, textile	White	54008608	4.770	6.178	6.262	573	644
P4 - E27	Blackblack	6	Black, textile	Black	54007908	4.770	6.178	6.262	573	644
P4 - 2x42W	White	6	Grey, textile	White	64009105	5.605	7.259	7.358	673	757
P4 - 2x42W	Black	6	Red, textile	White	64009008	5.605	7.259	7.358	673	757
P4 - DALI	White	6	Grey, textile	White	34020605	5.605	7.259	7.358	673	757
P4 - DALI	Black	6	Red, textile	White	34020508	5.605	7.259	7.358	673	757

Pendant P4: Made-to-order. Shipment 4 weeks from receipt of firm order.

### DIFFUSER

MODEL	COLOUR	PRODUCT CODE	DKK	SEK	NOK	GBP	EUR
P3	Opal	18173405	437	566	574	52	59
P4	Opal	18173505	437	566	574	52	59



# 7% rabatt ska dras av på angivna priser



## CARAVAGGIO™ CECILIE MANZ 2005

The Caravaggio™ range of high-gloss pendants was launched in 2005 and instantly singled out as a design icon. The distinctive red cord and the polished surface, clearly highlight one of the most striking pendant designs of the 2000s. The praised Cecilie Manz design elegantly combines a recognisable shape with a modern expression.

### TABLE

MODEL	COLOUR	CORD LGT. M	CORD SPECIFICATION	PRODUCT CODE	DKK	SEK	NOK	GBP	EUR
Table	White	2,5	Grey, textile	82081305	2.922	3.784	3.836	351	394
Table	Black	2,5	Black, textile	82081008	2.922	3.784	3.836	351	394

### TABLE PLUG-IN

MODEL	COLOUR	CORD LGT. M	CORD SPECIFICATION	PRODUCT CODE	DKK	SEK	NOK	GBP	EUR
Plug-in	White	2,5	Grey, textile	82081405	2.922	3.784	3.836	351	394
Plug-in	Black	2,5	Black, textile	82081108	2.922	3.784	3.836	351	394

### FLOOR

MODEL	COLOUR	CORD LGT. M	CORD SPECIFICATION	PRODUCT CODE	DKK	SEK	NOK	GBP	EUR
Floor	White	3	Grey, textile	81081505	5.442	7.048	7.144	654	735
Floor	Black	3	Black, textile	81081208	5.442	7.048	7.144	654	735

7% rabatt ska dras av på angivna priser

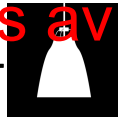

CARAVAGGIO™  
CECILIE MANZ 2005

PENDANT P0



PENDANT P1

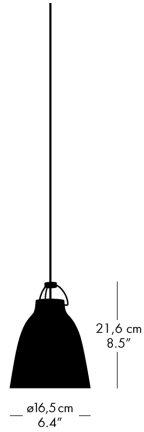

PENDANT P2

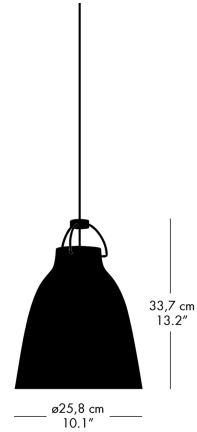

PENDANT P3

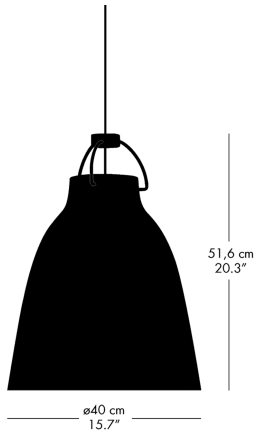

PENDANT P4

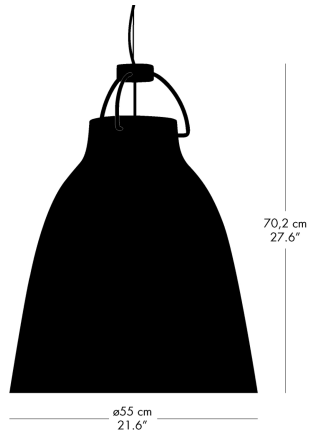

DIFFUSER P3 / P4



TABLE



TABLE PLUG-IN

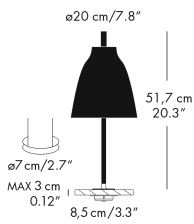

FLOOR

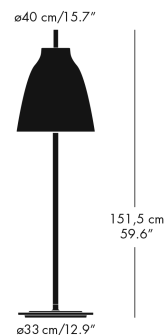



## CARAVAGGIO™ MATT CECILIE MANZ 2005

The completely matt finish adds a rare depth and tangibility and imbuing it with a warm, cosy feel. The delicate black, white and two grey tones are carefully balanced and interact elegantly with each other. The new tones from 2018 have their roots in nature's earthy hues: warm silk, archipelago stone, dark sienna and dark ultramarine. The discreet tones are timeless and suit more-or-less all settings.

### PENDANT

MODEL	COLOUR	CORD LGT. M	CORD SPECIFICATION	COLOUR CANOPY	PRODUCT CODE	DKK	SEK	NOK	GBP	EUR
P1	White	3	White, textile	White	14031113	1.494	1.935	1.961	179	202
P1	Grey25	3	Grey25, textile	White	14033112	1.494	1.935	1.961	179	202
P1	Grey45	3	Grey45, textile	White	14035112	1.494	1.935	1.961	179	202
P1	Black	3	Black, textile	Black	14037108	1.494	1.935	1.961	179	202
P1	Warm Silk	3	Grey45, textile	White	74626512	1.494	1.935	1.961	179	202
P1	Archipelago Stone	3	Grey45, textile	White	74626312	1.494	1.935	1.961	179	202
P1	Dark Sienna	3	Dark grey, textile	White	74626701	1.494	1.935	1.961	179	202
P1	Dark Ultramarine	3	Dark grey, textile	White	74626103	1.494	1.935	1.961	179	202
P2	White	3	White, textile	White	14031213	2.086	2.702	2.738	251	282
P2	Grey25	3	Grey25, textile	White	14033212	2.086	2.702	2.738	251	282
P2	Grey45	3	Grey45, textile	White	14035212	2.086	2.702	2.738	251	282
P2	Black	3	Black, textile	Black	14037208	2.086	2.702	2.738	251	282
P2	Warm Silk	3	Grey45, textile	White	74627312	2.086	2.702	2.738	251	282
P2	Archipelago Stone	3	Grey45, textile	White	74627112	2.086	2.702	2.738	251	282
P2	Dark Sienna	3	Dark grey, textile	White	74627501	2.086	2.702	2.738	251	282
P2	Dark Ultramarine	3	Dark grey, textile	White	74626903	2.086	2.702	2.738	251	282
P3	White	6	White, textile	White	14032213	3.800	4.921	4.988	456	513
P3	Grey25	6	Grey25, textile	White	14034212	3.800	4.921	4.988	456	513
P3	Grey45	6	Grey45, textile	White	14036212	3.800	4.921	4.988	456	513
P3	Black	6	Black, textile	Black	14038208	3.800	4.921	4.988	456	513
P3	Warm Silk	6	Grey45, textile	White	74627912	3.800	4.921	4.988	456	513
P3	Archipelago Stone	6	Grey45, textile	White	74627812	3.800	4.921	4.988	456	513
P3	Dark Sienna	6	Dark grey, textile	White	74628001	3.800	4.921	4.988	456	513
P3	Dark Ultramarine	6	Dark grey, textile	White	74627703	3.800	4.921	4.988	456	513
P4 - E27	White	6 w. wire	White, textile	White	14031413	4.770	6.178	6.262	573	644
P4 - E27	Grey25	6 w. wire	Grey25, textile	White	14033412	4.770	6.178	6.262	573	644
P4 - E27	Grey45	6 w. wire	Grey45, textile	White	14035412	4.770	6.178	6.262	573	644
P4 - E27	Black	6 w. wire	Black, textile	Black	14037408	4.770	6.178	6.262	573	644

### DIFFUSER

MODEL	COLOUR	PRODUCT CODE	DKK	SEK	NOK	GBP	EUR
P3	Opal	18173405	437	566	574	52	59
P4	Opal	18173505	437	566	574	52	59

# 7% rabatt ska dras av på angivna priser



## CARAVAGGIO™ MATT CECILIE MANZ 2005

The completely matt finish adds a rare depth and tangibility and imbuing it with a warm, cosy feel. The delicate black, white and two grey tones are carefully balanced and interact elegantly with each other. The new tones from 2018 have their roots in nature's earthy hues: warm silk, archipelago stone, dark sienna and dark ultramarine. The discreet tones are timeless and suit more-or-less all settings.

### TABLE

MODEL	COLOUR	CORD LGT. M	CORD SPECIFICATION	PRODUCT CODE	DKK	SEK	NOK	GBP	EUR
Table	Grey25	2,5	Grey25, textile	52403112	2.922	3.784	3.836	351	394

### TABLE PLUG-IN

MODEL	COLOUR	CORD LGT. M	CORD SPECIFICATION	PRODUCT CODE	DKK	SEK	NOK	GBP	EUR
Plug-in	Grey25	2,5	Grey25, textile	52403712	2.922	3.784	3.836	351	394

### FLOOR

MODEL	COLOUR	CORD LGT. M	CORD SPECIFICATION	PRODUCT CODE	DKK	SEK	NOK	GBP	EUR
Floor	Grey25	2,5	Grey25, textile	51403012	5.442	7.048	7.144	654	735

7% rabatt ska dras av på angivna priser

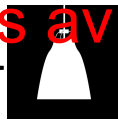

CARAVAGGIO™ MATT  
CECILIE MANZ 2005

PENDANT P0



PENDANT P1

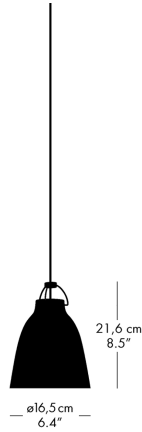

PENDANT P2

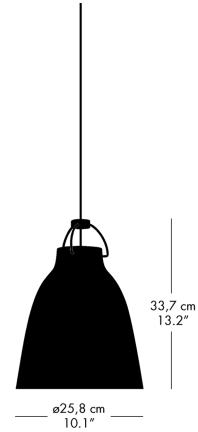

PENDANT P3

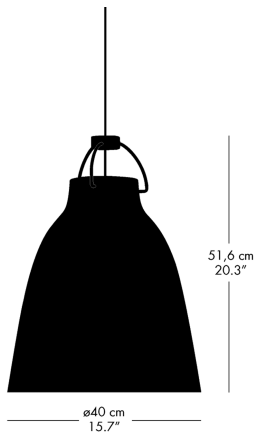

PENDANT P4

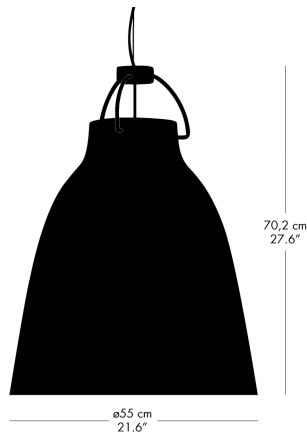

DIFFUSER P3 / P4

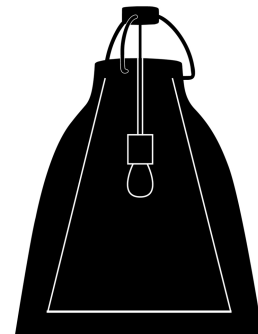

TABLE



TABLE PLUG-IN

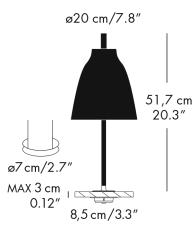

FLOOR

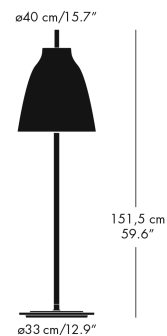

# 7% rabatt ska dras av på angivna priser



## CARAVAGGIO™ OPAL CECILIE MANZ 2005

With Caravaggio™ Opal, Cecilie Manz has combined the characteristic design with a completely different lighting effect. The opal glass shade emits a soft, dimmed light, which is particularly suitable for rooms where a more evocative lighting is required. The lamp is suspended by the three well-known shackles, which here form a raw and masculine contrast to the feminine opal hand-blown glass.

### PENDANT

MODEL	COLOUR	CORD LGT. M	CORD SPECIFICATION	COLOUR CANOPY	PRODUCT CODE	DKK	SEK	NOK	GBP	EUR
P0	Opal glass	3	Silver-grey, textile	White	84183005	1.362	1.764	1.788	164	184
P1	Opal glass	3	Silver-grey, textile	White	84183105	1.729	2.239	2.270	208	233
P2	Opal glass	3 w. wire	Silver-grey, textile	White	84183205	2.800	3.626	3.676	336	378
P3	Opal glass	6 w. wire	Silver-grey, textile	White	84184105	4.911	6.360	6.447	590	663

PENDANT P0

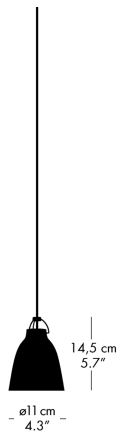

PENDANT P1

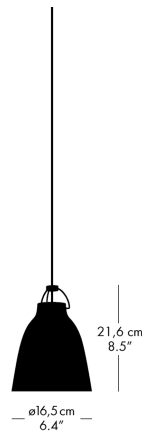

PENDANT P2

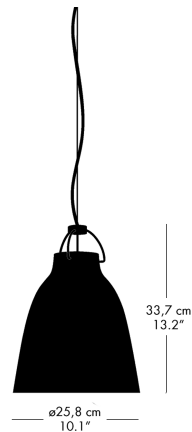

PENDANT P3

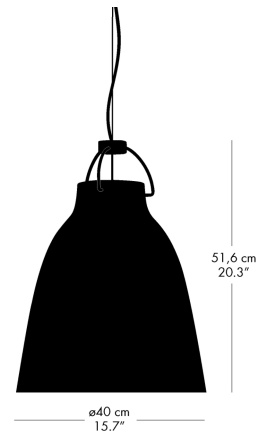

# 7% rabatt ska dras av på angivna priser

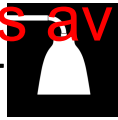

## CARAVAGGIO™ READ CECILIE MANZ 2005

Based on the well-known Caravaggio™ shape, Cecilie Manz has created a functional reading lamp series. The iconic shade is installed on a flexible tube, allowing you to tilt the shade and direct the light. The lamps can be rotated for different needs. The floor and table lamps are fitted with a 3-step touch-control dimmer for adjustment of light intensity. On the wall lamp, the switch is positioned discreetly at the bottom of the wall bracket to ensure easy access.

### WALL

MODEL	COLOUR	CORD LGT. M	CORD SPECIFICATION	PRODUCT CODE	DKK	SEK	NOK	GBP	EUR
White	White	1,5	White, PVC	23041405	1.669	2.162	2.191	200	225
Grey25	Grey25	1,5	Grey25, PVC	13041212	1.669	2.162	2.191	200	225
Black	Black	1,5	Grey45, PVC	23041308	1.669	2.162	2.191	200	225
Opal	Opal	1,5	Grey25, PVC	53403205	2.504	3.243	3.287	301	338

### TABLE

MODEL	COLOUR	CORD LGT. M	CORD SPECIFICATION	PRODUCT CODE	DKK	SEK	NOK	GBP	EUR
White	White	2,5	White, PVC	52697605	2.504	3.243	3.287	301	338
Grey25	Grey25	2,5	Grey25, PVC	52697812	2.504	3.243	3.287	301	338
Black	Black	2,5	Grey45, PVC	52697708	2.504	3.243	3.287	301	338
Opal	Opal	2,5	Grey25, PVC	52697905	3.340	4.326	4.384	401	451

### FLOOR

MODEL	COLOUR	CORD LGT. M	CORD SPECIFICATION	PRODUCT CODE	DKK	SEK	NOK	GBP	EUR
White	White	2,5	White, PVC	51697205	3.340	4.326	4.384	401	451
Grey25	Grey25	2,5	Grey25, PVC	51697412	3.340	4.326	4.384	401	451
Black	Black	2,5	Grey45, PVC	51697308	3.340	4.326	4.384	401	451
Opal	Opal	2,5	Grey25, PVC	51697505	4.177	5.410	5.483	502	564

### WALL

### TABLE

### FLOOR

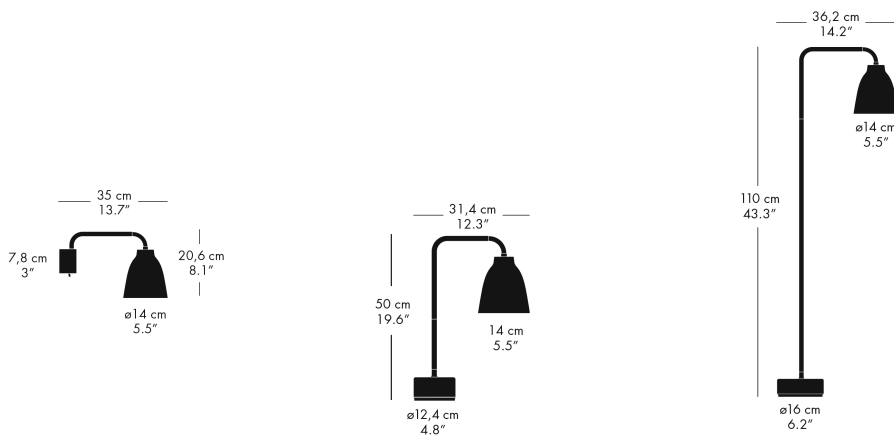

# 7% rabatt ska dras av på angivna priser

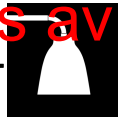

## CARAVAGGIO™ READ HSP CECILIE MANZ 2005

Since 2016, the Caravaggio™ Read series has proven its worth as a functional and aesthetic lighting solution for private homes. Now, the Read series is ready to move into the market of hotels and restaurants with a new and contract focused design. The HSP series - short for hospitality. Based on the same functionality as the original Read series, the HSP is designed to accommodate the challenges of the hospitality world with a simple design.

### WALL

MODEL	COLOUR	CORD LGT. M	CORD SPECIFICATION	PRODUCT CODE	DKK	SEK	NOK	GBP	EUR
White	White	1,5	Grey25, PVC	63700205	1.636	2.119	2.148	196	221
Grey25	Grey25	1,5	Grey25, PVC	63700412	1.636	2.119	2.148	196	221
Black	Black	1,5	Black, PVC	63700308	1.636	2.119	2.148	196	221
Opal (PC)	Grey25	1,5	Grey25, PVC	63700105	2.100	2.720	2.757	252	284

### TABLE

MODEL	COLOUR	CORD LGT. M	CORD SPECIFICATION	PRODUCT CODE	DKK	SEK	NOK	GBP	EUR
White	White	2,5	Grey25, PVC	62699705	2.460	3.186	3.229	295	332
Grey25	Grey25	2,5	Grey25, PVC	62699912	2.460	3.186	3.229	295	332
Black	Black	2,5	Black, PVC	62699808	2.460	3.186	3.229	295	332
Opal (PC)	Grey25	2,5	Grey25, PVC	62700005	2.900	3.756	3.807	348	392

### FLOOR

MODEL	COLOUR	CORD LGT. M	CORD SPECIFICATION	PRODUCT CODE	DKK	SEK	NOK	GBP	EUR
White	White	2,5	Grey25, PVC	61705205	3.276	4.243	4.300	393	442
Grey25	Grey25	2,5	Grey25, PVC	61705412	3.276	4.243	4.300	393	442
Black	Black	2,5	Black, PVC	61705308	3.276	4.243	4.300	393	442
Opal (PC)	Grey25	2,5	Grey25, PVC	61705505	4.095	5.303	5.376	492	553

#### WALL

#### TABLE

#### FLOOR

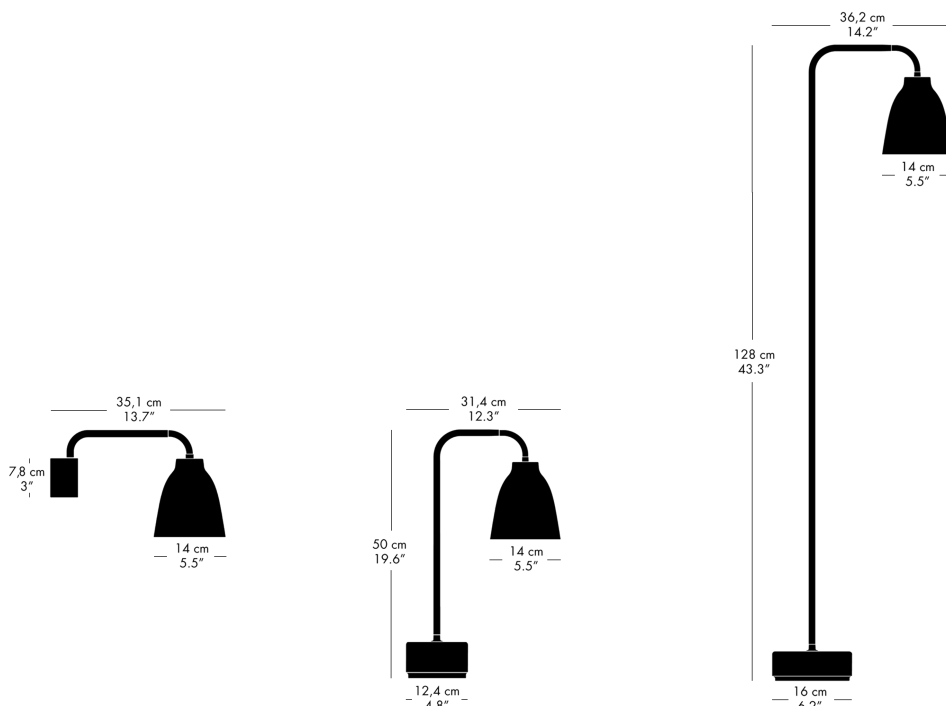



# 7% rabatt ska dras av på angivna priser



## CONCERT™ JØRN UTZON 2005

Concert™ gives a pleasant, non-glaring light without compromising the strength of illumination. The chosen shade configuration is visually characteristic of Jørn Utzon and reminds us of his greatest work — the Sydney Opera House. Concert™ is designed with four shades and a parabola of drawn steel, resting on a glass cone suspension. The suspension unit sends out a pleasant, even light between the shades. The bottom shade casts light downward to the parabola, which then diffuses it.

### PENDANT

MODEL	COLOUR	CORD LGT. M	CORD SPECIFICATION	COLOUR CANOPY	PRODUCT CODE	DKK	SEK	NOK	GBP	EUR
P1	White	3	White, textile	White	54003405	2.382	3.085	3.127	286	322
P3	White	6 w. wire	White, textile	White	74003505	4.299	5.568	5.643	516	580

#### PENDANT P1

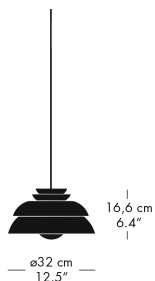

#### PENDANT P3

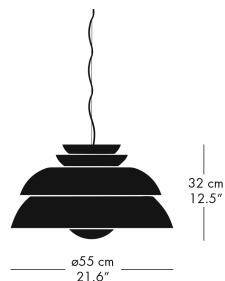

# 7% rabatt ska dras av på angivna priser

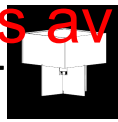

## CROSS-PLEX™ BODIL KJÆR 1961

Cross-Plex™ is a great example of Bodil Kjaer's functionalistic expression with its clean and straight lines. It is centred on a cross-base of clear acrylic that creates an elegant play of surfaces and incorporates the cord as a central part of the design. The light from the cubic lampshade, shaped in opal acrylic, create a cosy atmosphere.

### TABLE

MODEL	COLOUR	CORD LGT. M	CORD SPECIFICATION	PRODUCT CODE	DKK	SEK	NOK	GBP	EUR
T-300	Opal/clear	3	Black, textile	82716605	2.396	3.103	3.145	288	323
T-500	Opal/clear	3	Black, textile	82716705	2.196	2.844	2.883	264	296

TABLE T-300

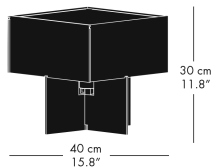
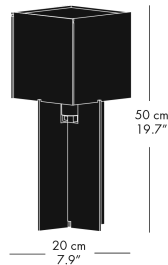

TABLE T-500



# 7% rabatt ska dras av på angivna priser



DOGU™

MICHAEL GEERTSEN 2016

The name Dogu™ is Japanese and refers to old traditional figurines portraying animals and humanoids. The shade is made of bone china – an exclusive material created from actual bone powder and white clay. The translucent material ensures that the light projects through the shade and renders the lamp light, warm and extremely cosy at the same time.

## PENDANT

MODEL	COLOUR	CORD LGT. M	CORD SPECIFICATION	COLOUR CANOPY	PRODUCT CODE	DKK	SEK	NOK	GBP	EUR
Gold	Gold	3	Gold, textile	White	64705605	2.636	3.414	3.460	317	356
Silver	Silver	3	Silver, textile	White	64705705	2.636	3.414	3.460	317	356

## PENDANT

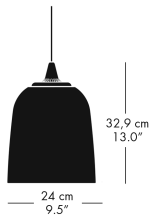

# 7% rabatt ska dras av på angivna priser

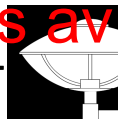

## HL™ 410

HENNING LARSEN 1975

HL™ provides a diffuse light. The HL™ lamp is constructed from warm-galvanized steel, untreated copper and clear/opal acrylic. In time, the untreated copper shade takes on a characteristic dark look and eventually it becomes the classic verdigris colour. Thus the outdoor lamp grows more beautiful year after year.

### POST TOP\*

MODEL	COLOUR	PRODUCT CODE	DKK	SEK	NOK	GBP	EUR
HL410	Copper/Clear acrylic	10681064	3.431	4.443	4.504	412	463

\* ) delivered excl. pole

### WALL

MODEL	COLOUR	PRODUCT CODE	DKK	SEK	NOK	GBP	EUR
HL410	Galvanized steel/copper/clear acrylic	10680964	3.929	5.088	5.158	472	530

#### POST TOP HL410

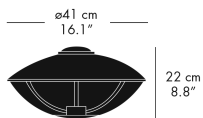

#### WALL HL410

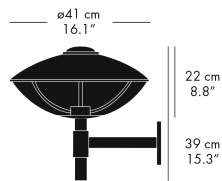

# 7% rabatt ska dras av på angivna priser



## JUICY™ SALTO & SIGSGAARD 2011

The Juicy™ pendant is logical, simple and functional. The various parts of the lamps: the wire, cone and shade come together seamlessly, which makes the pendant seem like an organic whole. Towards the bottom, Juicy™ is finished off with a honeycomb-filter, which effectively concentrates the light while preventing dazzle at the same time. The glossy surface is visually broken by a shiny ring, which marks where the lamp can be separated for change of light source.

### PENDANT

MODEL	COLOUR	CORD LGT. M	CORD SPECIFICATION	COLOUR CANOPY	PRODUCT CODE	DKK	SEK	NOK	GBP	EUR
White	White	6	White, textile	White	94183505	2.994	3.878	3.930	360	404
Black	Black	6	Black, textile	Black	94183608	2.994	3.878	3.930	360	404

### PENDANT

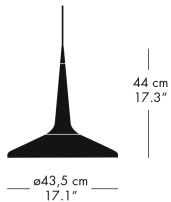



**KAISER IDELL™**  
CHRISTIAN DELL 1931

KAISER idell™ is the result of a long-standing tradition for creating original and timeless design. Dedicated craftsmanship and carefully selected materials ensure that the KAISER idell™ is of the highest quality and will remain beautiful and durable. The lamps are made of steel and brass and the lampshades are hand painted in high gloss or matt (only available in black). The chrome-plated elements consist of polished and silver-soldered brass.

## PENDANT

MODEL	COLOUR	CORD LGT. M	CORD SPECIFICATION	COLOUR CANOPY	PRODUCT CODE	DKK	SEK	NOK	GBP	EUR
6631-P	White	3	Black, textile	Silver	64700505	2.004	2.595	2.631	241	271
6631-P	Black	3	Black, textile	Silver	64700608	2.004	2.595	2.631	241	271
6631-P	Matt black	3	Black, textile	Silver	64700708	2.004	2.595	2.631	241	271
6631-P	Ruby Red	3	Black, textile	Silver	64700801	2.004	2.595	2.631	241	271

## WALL

MODEL	COLOUR	CORD LGT. M	CORD SPECIFICATION	PRODUCT CODE	DKK	SEK	NOK	GBP	EUR
6718-W	White	2	Black, textile	63702305	3.402	4.406	4.466	409	459
6718-W	Black	2	Black, textile	63702408	3.402	4.406	4.466	409	459
6718-W	Matt black	2	Black, textile	63702508	3.402	4.406	4.466	409	459

## TABLE

MODEL	COLOUR	CORD LGT. M	CORD SPECIFICATION	PRODUCT CODE	DKK	SEK	NOK	GBP	EUR
6556-T	White	2	Black, textile	62702905	3.177	4.115	4.170	382	429
6556-T	Black	2	Black, textile	62703008	3.177	4.115	4.170	382	429
6556-T	Matt black	2	Black, textile	62703108	3.177	4.115	4.170	382	429
6631-T Luxus	White	2	Black, textile	62701305	3.993	5.171	5.242	480	539
6631-T Luxus	Black	2	Black, textile	62701408	3.993	5.171	5.242	480	539
6631-T Luxus	Matt black	2	Black, textile	62701508	3.993	5.171	5.242	480	539
6631-T Luxus	Ruby Red	2	Black, textile	62701601	3.993	5.171	5.242	480	539
6631-T Luxus	Dark Green	2	Black, textile	62701706	3.993	5.171	5.242	480	539

## FLOOR

MODEL	COLOUR	CORD LGT. M	CORD SPECIFICATION	PRODUCT CODE	DKK	SEK	NOK	GBP	EUR
6556-F	White	2	Black, textile	61703505	4.595	5.951	6.032	552	620
6556-F	Black	2	Black, textile	61703608	4.595	5.951	6.032	552	620
6556-F	Matt black	2	Black, textile	61703708	4.595	5.951	6.032	552	620
6580-F Luxus	White	2	Black, textile	61704105	5.013	6.492	6.581	602	677
6580-F Luxus	Black	2	Black, textile	61704208	5.013	6.492	6.581	602	677
6580-F Luxus	Matt black	2	Black, textile	61704308	5.013	6.492	6.581	602	677



KAISER IDELL™  
CHRISTIAN DELL 1931

PENDANT 6631-P

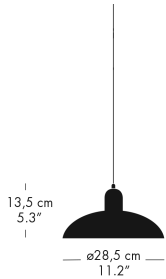

WALL 6718-W



TABLE 6556-T



TABLE 6631-T LUXUS

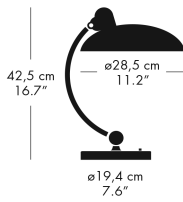

FLOOR 6556-F

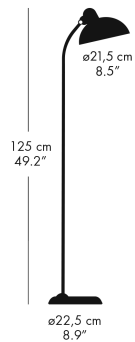

FLOOR 6580-F LUXUS

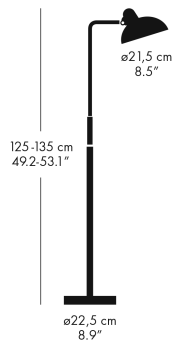

# 7% rabatt ska dras av på angivna priser



LULLABY™  
MONICA FÖRSTER 2014

The Lullaby™ is formed into a pentagonal, yet slightly organic-looking shape using five slender ash lamellae. The ash gives the diffuse shade stability, shape and character. In addition, the shade has outstanding luminous qualities, which enable the Lullaby™ to emit a soft, muted light.

## PENDANT

MODEL	COLOUR	CORD LGT. M	CORD SPECIFICATION	COLOUR CANOPY	PRODUCT CODE	DKK	SEK	NOK	GBP	EUR
P1	Translucent (PE)	3	White, textile	White	34301005	1.127	1.460	1.479	135	152
P2	Translucent (PE)	3	White, textile	White	34301105	1.586	2.054	2.082	190	214
P3	Translucent (PE)	6	White, textile	White	34301205	2.504	3.243	3.287	301	338

FSC approved ash wood

### PENDANT P1

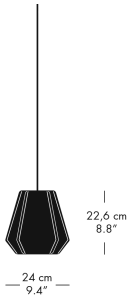

### PENDANT P2

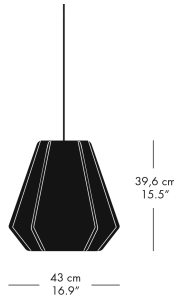

### PENDANT P3

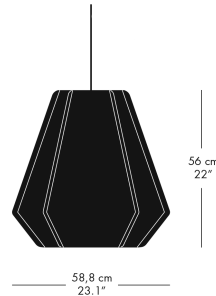



# 7% rabatt ska dras av på angivna priser



## MINGUS™ CECILIE MANZ 2011

Mingus™ is organic even if it originates in four straight facets. The lamp's top is flat and fitted with an acrylic fixture that allows light to seep out. The Mingus™ pendant is available in six matt nuances. In addition to Pure White, there are five other tones carefully selected by Cecilie Manz: Nearly Black, Very Grey, Pale Moss, Light Celadon and Dusty Limestone. The tones change in different lights and take on the colour of their surroundings.

### PENDANT

MODEL	COLOUR	CORD LGT. M	CORD SPECIFICATION	COLOUR CANOPY	PRODUCT CODE	DKK	SEK	NOK	GBP	EUR
P1	Very Grey	3	Grey25, textile	White	24197011	1.244	1.611	1.633	149	168
P1	Pale Moss	3	Grey25, textile	White	24197110	1.244	1.611	1.633	149	168
P1	Dusty Limestone	3	Grey25, textile	White	24197203	1.244	1.611	1.633	149	168
P1	Nearly Black	3	Grey25, textile	White	24197309	1.244	1.611	1.633	149	168
P1	Light Celadon	3	Grey25, textile	White	24197404	1.244	1.611	1.633	149	168
P1	White	3	White, textile	White	24197505	1.244	1.611	1.633	149	168
P2	Very Grey	3	Grey25, textile	White	24198011	2.132	2.761	2.799	256	288
P2	Pale Moss	3	Grey25, textile	White	24198110	2.132	2.761	2.799	256	288
P2	Dusty Limestone	3	Grey25, textile	White	24198203	2.132	2.761	2.799	256	288
P2	Nearly Black	3	Grey25, textile	White	24198309	2.132	2.761	2.799	256	288
P2	Light Celadon	3	Grey25, textile	White	24198404	2.132	2.761	2.799	256	288
P2	White	3	White, textile	White	24198505	2.132	2.761	2.799	256	288

#### PENDANT P1

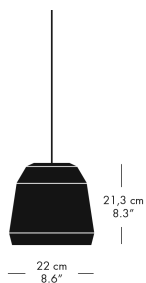

#### PENDANT P2

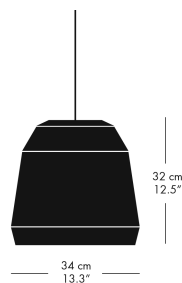

# 7% rabatt ska dras av på angivna priser



## NIGHT OWL™ NIKOLAI WIIG HANSEN 2015

The Night Owl™ consists of a conical base and oval shade, merging together to form a single unit of balanced proportions. Its organic design gives the lamp a friendly and almost human appearance – it's a lamp with a personality! Night Owl™ is suitable for standing on e.g. a sideboard, shelf, bedside table or in a window.

### TABLE

MODEL	COLOUR	CORD LGT. M	CORD SPECIFICATION	PRODUCT CODE	DKK	SEK	NOK	GBP	EUR
Monochrome	Midnight Blue	2	Black, textile	52698203	994	1.287	1.305	119	134
Monochrome	Smokey White	2	Black, textile	52698305	994	1.287	1.305	119	134
Colour/Ash	Midnight Blue/Ash	2	Black, textile	52698003	1.250	1.619	1.641	150	169
Colour/Ash	Smokey White/Ash	2	Black, textile	52698105	1.250	1.619	1.641	150	169

### TABLE

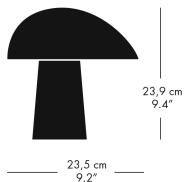

# 7% rabatt ska dras av på angivna priser



**ORIENT™**  
JO HAMMERBORG 1963

Orient™ was designed by Jo Hammerborg in 1963 and relaunched by Lightyears in 2013, in one of the original five different surfaces. In close collaboration with the Hammerborg family, the Orient™ pendant is a flawless light design with excellent luminous efficacy and made from the finest quality materials. The organic design expression beautifully connects the deep. The pendants ensures a soft, pleasant light without any glare.

## PENDANT

MODEL	COLOUR	CORD LGT. M	CORD SPECIFICATION	COLOUR CANOPY	PRODUCT CODE	DKK	SEK	NOK	GBP	EUR
P1	Aluminium/Oak	3	Grey, textile	White	84716372	1.796	2.326	2.358	216	242
P1	Black/Rosewood	3	Black, textile	Black	34192108	1.668	2.160	2.190	200	225
P1	Copper/Rosewood	3	Black, textile	Black	34192064	2.504	3.243	3.287	301	338
P2	Aluminium/Oak	3	Grey, textile	White	84716472	2.716	3.517	3.565	326	367
P2	Black/Rosewood	3	Black, textile	Black	34192308	2.504	3.243	3.287	301	338
P2	Copper/Rosewood	3	Black, textile	Black	34192264	3.759	4.868	4.934	451	507
P3	Aluminium/Oak	6	Grey, textile	White	84716572	4.356	5.641	5.718	523	588
P3	Black/Rosewood	6	Black, textile	Black	34192808	4.177	5.410	5.483	502	564

PENDANT P1

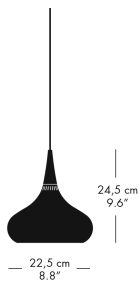

PENDANT P2

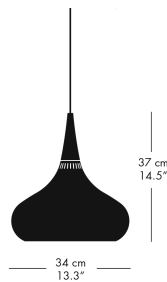

PENDANT P3

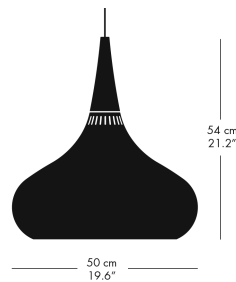

# 7% rabatt ska dras av på angivna priser

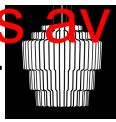

## PALLAS™ FJORMFJORD 2012

Pallas™ is a contemporary large room pendant with a unique character inspired by historic chandeliers. The vertical laser-cut slits in the shade create openings for the light and create a sophisticated interplay of light and shadow. With its substantial size, Pallas™ is made to illuminate grand architectural projects such as lobbies, airports, theatres or museums.

### PENDANT

MODEL	COLOUR	CORD LGT. M	CORD SPECIFICATION	COLOUR CANOPY	PRODUCT CODE	DKK	SEK	NOK	GBP	EUR
White	White	6 w. wire	White, PVC	White	24200905	14.234	18.434	18.685	1.710	1.922
Black	Black	6 w. wire	Black, PVC	Black	24201008	14.234	18.434	18.685	1.710	1.922

Made-to-order. Shipment 4 weeks from receipt of firm order.

### PENDANT

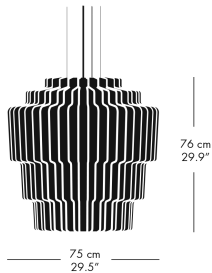

# 7% rabatt ska dras av på angivna priser



**RADON™**

HANS SANDGREN JAKOBSEN 2010

The fundamental geometric forms – the circle and the triangle – are key elements in the design of the Radon™ series. The light from Radon™ is direct and adjustable. The shade is multi-directional and furnished with an asymmetrical reflector, ensuring that light spreads out precisely to the surface where it is needed. The switch is placed at the top of the lamp, while the cord leads discreetly out of the back leg to help preserve the lamp's clean lines.

## WALL

MODEL	COLOUR	CORD LGT. M	CORD SPECIFICATION	PRODUCT CODE	DKK	SEK	NOK	GBP	EUR
Alba	Alba	3,3	Black, PVC	83182405	1.586	2.054	2.082	190	214
Nigra	Nigra	3,3	Black, PVC	53182208	1.586	2.054	2.082	190	214

## TABLE

MODEL	COLOUR	CORD LGT. M	CORD SPECIFICATION	PRODUCT CODE	DKK	SEK	NOK	GBP	EUR
Alba	Alba	2,5	Black, PVC	62705005	2.698	3.494	3.542	324	364
Nigra	Nigra	2,5	Black, PVC	52182108	2.698	3.494	3.542	324	364

## FLOOR

MODEL	COLOUR	CORD LGT. M	CORD SPECIFICATION	PRODUCT CODE	DKK	SEK	NOK	GBP	EUR
Alba	Alba	2,5	Black, PVC	61705105	3.596	4.657	4.720	432	485
Nigra	Nigra	2,5	Black, PVC	51182308	3.596	4.657	4.720	432	485

### WALL

### TABLE

### FLOOR

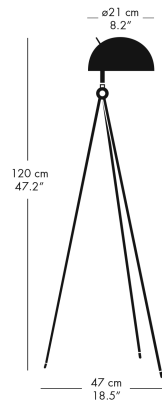
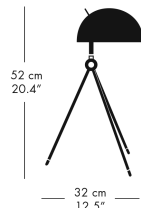
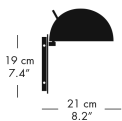

# 7% rabatt ska dras av på angivna priser

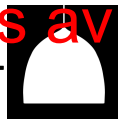

**SUSPENCE™**  
GAMFRATESI 2013

GamFratesi's inspiration for the Suspence™ lamp series is translating a movement into a physical shape. The infinity diffuser concentrates the light and prevents glare and creates an elegant optical illusion of infinite depth. Suspence™ Nomad is designed to be moved around in the home e.g. on the floor, staircase or terrace, just like a nomad. The lamp is easily carried by the silicone handle at the top.

## PENDANT

MODEL	COLOUR	CORD LGT. M	CORD SPECIFICATION	COLOUR CANOPY	PRODUCT CODE	DKK	SEK	NOK	GBP	EUR
P1	White	3	Matt white, PVC	White	54400205	1.668	2.160	2.190	200	225
P1	Light grey	3	Matt light grey, PVC	White	54400612	1.668	2.160	2.190	200	225
P1	Black	3	Matt black, PVC	Black	54400508	1.668	2.160	2.190	200	225
P1	Copper	3	Matt black, PVC	Black	54403364	2.607	3.376	3.422	313	352
P2	White	3	Matt white, PVC	White	54400305	2.922	3.784	3.836	351	394
P2	Light grey	3	Matt light grey, PVC	White	54400812	2.922	3.784	3.836	351	394
P2	Black	3	Matt black, PVC	Black	54400708	2.922	3.784	3.836	351	394
P2	Copper	3 w. wire	Matt black, PVC	Black	54403564	5.300	6.864	6.957	637	716

## FLOOR

MODEL	COLOUR	CORD LGT. M	CORD SPECIFICATION	PRODUCT CODE	DKK	SEK	NOK	GBP	EUR
Nomad	Opal	4	Grey, PVC	52403812	1.586	2.054	2.082	190	214
Nomad	Opal	4	Red, PVC	52400401	1.586	2.054	2.082	190	214

PENDANT P1

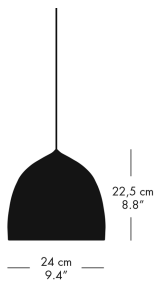

PENDANT P2

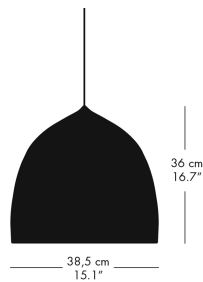

PENDANT P2 W. WIRE

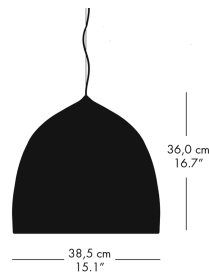

FLOOR NOMAD

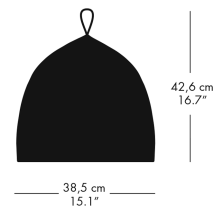

# 7% rabatt ska dras av på angivna priser

## Välkommen till Skandinavians ledande inredningsföretag

Vi tillhandahåller behovsanpassad inredning utifrån kundens förutsättningar beträffande design, profil, funktion, ergonomi och ekonomi. Vi arbetar med kontor, hotell och restaurang, skola och utbildning samt vård och omsorg.

## Input sedan 1987

Att gestalta en miljö som människor kan trivas och jobba effektivt i är ett hantverk som handlar om lika delar planering och finurlighet. Sedan 1987 har vi utvecklats till en komplett leverantör av inredning; allt från projektledning, upphandling till leverans, montering och efterservice. Läs mer om oss på [www.inputinterior.se](http://www.inputinterior.se).

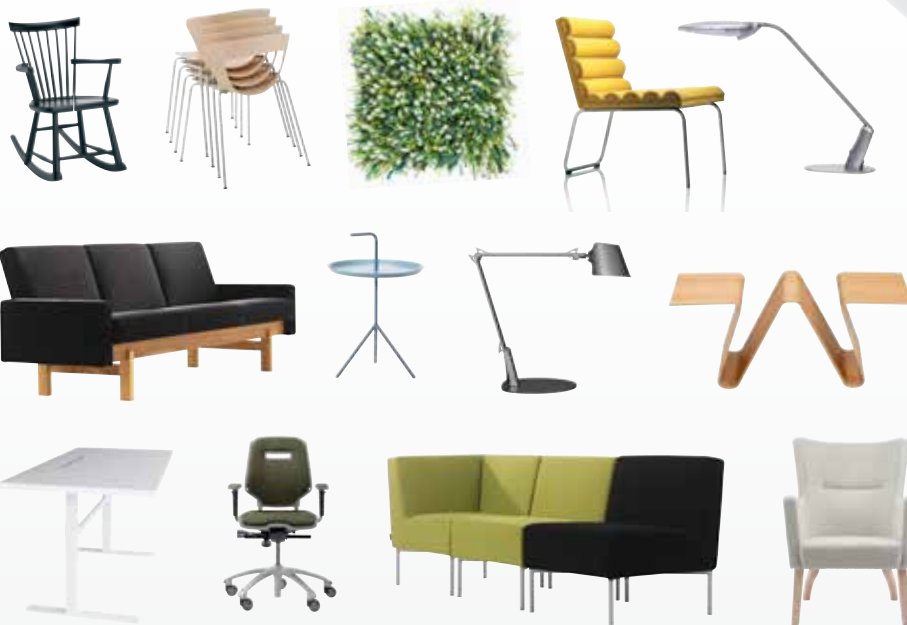

**En kund · ett datum · en leverans**