

7% rabatt ska dras av på angivna priser



## H - Inredningsarmaturer

Normann Copenhagen

7%



# 7% rabatt ska dras av på angivna priser



## Våra kontor

### Borås

Olovsholmsgatan 25  
506 34 Borås

+46 (0)33 21 11 00  
boras@inputinterior.se

### Jönköping

Huskvarnavägen 64  
554 54 Jönköping

+46 (0)36 585 95 30  
jonkoping@inputinterior.se

### Kinna

Boråsvägen 17  
511 56 Kinna

+46 (0)320 20 90 30  
kinna@inputinterior.se

### Malmö

Flygplansgatan 9  
212 39 Malmö

+46 (0)40 20 66 00  
malmo@inputinterior.se

### Stockholm

Sveavägen 145  
113 46 Stockholm

+46 (0)8 517 112 00  
stockholm@inputinterior.se

### Västerås

Metallverksgatan 4B  
721 30 Västerås

+46 (0)21 80 30 30  
vasteras@efg.se

### Örebro

Radiatorvägen 2  
702 27 Örebro

+46 (0)19 767 35 80  
orebro@inputinterior.se

### Göteborg

Fältspatsgatan 2  
421 30 Västra Frölunda

+46 (0)31 799 89 00  
goteborg@inputinterior.se

### Kalmar

Engelska vägen 5  
392 39 Kalmar

+46 (0)480 578 00  
kalmar@inputinterior.se

### Kristianstad

Västra Storgatan 51K  
291 31 Kristianstad

+46 (0)44 785 08 40  
kristianstad@inputinterior.se

### Norrköping

Västgötegatan 13B  
602 21 Norrköping

+46 (0)11 440 94 00  
norrkoping@inputinterior.se

### Sundsvall

Strandgatan 14  
852 31 Sundsvall

+46 (0)60 52 50 10  
sundsvall@efg.se

### Växjö

Södra Vallviksvägen 10  
352 51 Växjö

+46 (0)470 79 37 00  
vaxjo@inputinterior.se

### Halmstad

Flygaregatan 8  
302 38 Halmstad

+46 (0)35 295 85 00  
halmstad@inputinterior.se

### Karlskrona

Blekingegatan 6A  
371 34 Karlskrona

+46 (0)455 68 88 20  
karlskrona@inputinterior.se

### Linköping

Gottorpsgatan 57  
581 19 Linköping

+46 (0)13 36 44 50  
linkoping@inputinterior.se

### Skellefteå

Brogatan 3  
931 62 Skellefteå

+46 (0)910 48 84 60  
skelleftea@inputinterior.se

### Uppsala

Sjukhusvägen 3  
753 09 Uppsala

+46 (0)18 430 53 04  
uppsala@inputinterior.se

### Helsingborg

Ekslingan 2  
254 67 Helsingborg

+46 (0)42 444 96 30  
helsingborg@inputinterior.se

### Karlstad

Blockgatan 10  
653 41 Karlstad

+46 (0)54 775 66 60  
karlstad@inputinterior.se

### Luleå

Bangårdsgatan 14  
972 75 Luleå

+46 (0)920 46 64 30  
lulea@inputinterior.se

### Skövde

Gustav Adolfs gata 31  
541 45 Skövde

+46 (0)500 77 93 80  
skovde@inputinterior.se

### Umeå

Björnvägen 19  
906 40 Umeå

+46 (0)90 34 00 160  
umea@inputinterior.se

## Input interiör i Norden

Se [inputinterior.se](http://inputinterior.se) för adresser och kontaktuppgifter till våra kontor i Danmark, Finland och Norge samt till alla våra medarbetare.

# 7% rabatt ska dras av på angivna priser

## ACROBAT EU

Design: Marc Venot, 2014  
 Awards: German Design Award 2017, Germany  
 Duty Code: 9405204000  
 Made in: China

Construction: The Acrobat Lamp consists of 2 separate parts which are held together by a strong magnet. This construction makes it possible to move the lamp part in diverse directions from the base. Acrobat is made with a permanently integrated low-energy LED light source. Be aware that the product contains a strong magnet. Construction video: <https://www.youtube.com/watch?v=SjplQII9KHA2> m textile cord with switch, matching color (grey / sand / aubergine / black).

Maintenance: Clean with damp cloth.

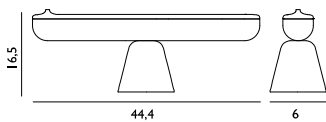

### Acrobat Table Lamp EU

Contract Price  
 SEK 1.895,20

Colli: 1  
 Size & Weight: H: 16,5 x L: 44,4 x D: 6 cm - 2,1 kg  
 Packing: Gift Box - H: 59 x L: 14,5 x D: 13,5 cm - 2,5 kg  
 Material: Plastic, Magnetic Base, Acrylic Diffuser with Magnet  
 Light Source: 6,5 Watt LED (included). Power: 6.5W. Light output: 455lm.  
 Color temperature: 2800K-3200K. Ra> 80. LED life span - 30000hrs, Energy efficiency class: A.



502122  
 Grey



502123  
 Sand



502124  
 Aubergine



502125  
 Black

## AMP EU

Design: Simon Legald, 2014  
 Duty Code: 9405105000  
 Made in: China

Construction: Table lamps with gold glass are provided with a 2 m green textile cord with a switch. Pendants with gold glass are provided with 4 m green textile cord and a black ceiling canopy. Tables lamps with smoke glass are provided with a 2 m black textile cord with a switch. Pendants with smoke glass are provided with a 4 m black textile cord and a black canopy. Table lamps with white glass are provided with a 2 m white textile cord with a switch. Pendants with white glass are provided with 4 m white textile cord and a white ceiling canopy.

Maintenance: Clean with damp cloth. Avoid use of all-purpose cleaners and other degreasing detergents.

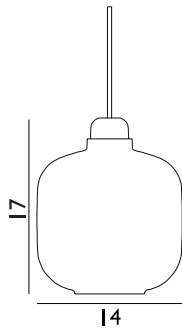

### Amp Lamp Small EU

Contract Price  
 SEK 896,00

Colli: 1  
 Size & Weight: H: 17 x Ø: 14 cm - 0,6 kg  
 Packing: Gift Box - H: 33,7 x L: 19,4 x D: 19,2 cm - 1 kg  
 Colli Box: H: 33,7 x L: 19,4 x D: 19,2 cm - 1,5 kg  
 M3: 0,0126  
 Material: Glass, Marble  
 Light Source: EU E14 0,5W bulbs (LED). All Bulbs can be purchased separately.



502073  
 White /  
 White



502116  
 Smoke /  
 Black



502117  
 Gold /  
 Green

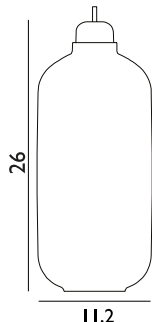

### Amp Lamp Large EU

Contract Price  
 SEK 896,00

Colli: 1  
 Size & Weight: H: 26 x Ø: 11,2 cm - 0,6 kg  
 Packing: Gift Box - H: 42,6 x L: 17,5 x D: 16,5 cm - 1,2 kg  
 Colli Box: H: 42,6 x L: 17,5 x D: 16,5 cm  
 M3: 0,0123  
 Material: Glass, Marble  
 Light Source: EU E14 0,5W bulbs (LED). All Bulbs can be purchased separately.



502074  
 White /  
 White



502118  
 Smoke /  
 Black



502119  
 Gold /  
 Green

# 7% rabatt ska dras av på angivna priser

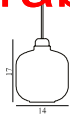

## Amp Lamp Small Brass EU

Colli: 1  
 Size & Weight: H: 17 x Ø: 14 cm - 0,9 kg  
 Packing: Gift Box - H: 33,7 x L: 19,4 x D: 19,2 cm - 1 kg  
 Colli Box: H: 33,7 x L: 19,4 x D: 19,2 cm - 1,5 kg  
 M3: 0,0126  
 Material: Glass, Brass  
 Light Source: EU E14 0,5W bulbs (LED). All Bulbs can be purchased separately.

Contract Price  
 SEK 1.000,00



502164  
 Smoke /  
 Brass



502165  
 White /  
 Brass

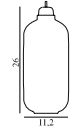

## Amp Lamp Large Brass EU

Colli: 1  
 Size & Weight: H: 26 x Ø: 11,2 cm  
 Packing: Gift Box - H: 42,6 x L: 17,5 x D: 16,5 cm - 1,2 kg  
 Colli Box: H: 42,6 x L: 17,5 x D: 16,5 cm  
 M3: 0,0123  
 Material: Glass, Brass  
 Light Source: EU E14 0,5W bulbs (LED). All Bulbs can be purchased separately.

Contract Price  
 SEK 1.000,00



502166  
 Smoke /  
 Brass



502167  
 White /  
 Brass

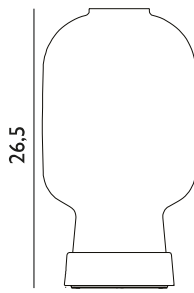

14

## Amp Table Lamp EU

Colli: 1  
 Size & Weight: H: 26,5 x Ø: 14 cm - 1,7 kg  
 Packing: Gift Box - H: 47 x L: 20,5 x D: 20,5 cm - 2,2 kg  
 Colli Box: H: 47 x L: 20,5 x D: 20,5 cm  
 M3: 0,0198  
 Material: Glass, Marble  
 Light Source: EU E14 0,5W bulbs (LED). All Bulbs can be purchased separately.

Contract Price  
 SEK 1.496,00



502075  
 White /  
 White



502120  
 Smoke /  
 Black



502121  
 Gold /  
 Green

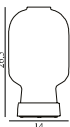

## Amp Table Lamp Brass EU

Colli: 1  
 Size & Weight: H: 26,5 x Ø: 14 cm  
 Packing: Gift Box - H: 47 x L: 20,5 x D: 20,5 cm - 2,2 kg  
 Colli Box: H: 47 x L: 20,5 x D: 20,5 cm  
 M3: 0,0198  
 Material: Glass, Brass  
 Light Source: EU E14 0,5W bulbs (LED). All Bulbs can be purchased separately.

Contract Price  
 SEK 1.800,00



502168  
 Smoke /  
 Brass



502169  
 White /  
 Brass

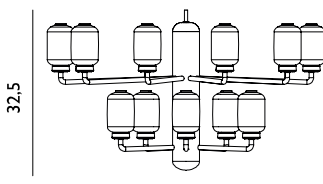

62,5

## Amp Chandelier Small EU

Colli: 1  
 Size & Weight: H: 32,5 x Ø: 62,5 cm - 4,4 kg  
 Packing: Brown Box - H: 40 x L: 67 x D: 65 cm - 7,43 kg  
 M3: 0,1742  
 Material: Glass, Marble  
 Light Source: Comes with 15 bulbs (G4 (LED)). All Bulbs can also be purchased separately. The Amp Chandelier is non-dimmable.

Contract Price  
 SEK 6.096,00



502076  
 Smoke /  
 Black



502077  
 Gold /  
 Green



502078  
 White /  
 White

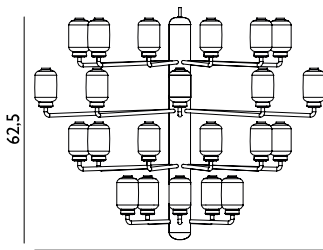

85

## Amp Chandelier Large EU

Colli: 1  
 Size & Weight: H: 62,5 x Ø: 85 cm - 7,4 kg  
 Packing: Brown Box - H: 69 x L: 88 x D: 87 cm - 17,5 kg  
 M3: 0,5283  
 Material: Glass, Marble  
 Light Source: Comes with 35 bulbs (G4 (LED)). All Bulbs can also be purchased separately. The Amp Chandelier is non-dimmable.

Contract Price  
 SEK 12.296,00



502079  
 Smoke /  
 Black



502080  
 Gold /  
 Green





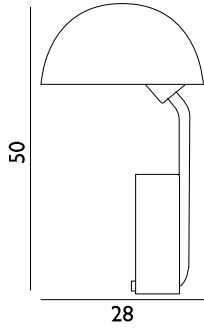

502081  
 White /  
 White

# CAP EU 7% rabatt ska dras av på angivna priser

Design: KaschKasch, 2014  
 Duty Code: 9405209990  
 Made in: China  
 Construction: The lampshade can be moved around, letting you direct the light. Delivered with 2 m textile cord with switch.  
 Maintenance: Clean with damp cloth.



Cap Table Lamp EU		Contract Price
Coll:	I	SEK 2.200,00
Size & Weight:	H: 50 x Ø: 28 cm - 3,7 kg	
Packing:	Brown Box - H: 49 x L: 34 x D: 32 cm - 3,9 kg	
M3:	0,0533	
Material:	Steel	
Light Source:	EU E27 (big socket). Bulb is not included. Low-energy 8 Watt bulbs are recommended.	
	505041 White	
	505042 Blush	
	505043 Misty Blue	
	505044 Midnight Blue	

## CORDS & CANOPIES

Design: Normann Copenhagen, 2008  
 Duty Code: 85444991  
 Made in: China  
 Construction: Suitable for Norm 69, Norm 12, Norm 06 and Norm 03 lamps.  
 Maintenance: Clean with damp cloth.



Cord w. Fitting EU		Contract Price
Coll:	I	SEK 72,00
Size & Weight:	L: 250 cm - 0,2 kg	
Packing:	Clear Poly bag - 0,2 kg	
Material:	Plastic	
Light Source:	E27 (big socket). Low-energy 9 Watt bulbs are recommended.	
	505000 White	



Cord w. Fitting & Canopy EU		Contract Price
Coll:	I	SEK 80,00
Size & Weight:	L: 250 cm - 0,2 kg	
Packing:	Clear Poly bag - 0,2 kg	
Material:	Plastic	
Light Source:	E27 (big socket). Low-energy 9 Watt bulbs are recommended.	
	505002 White	

Cord w. Fitting & Canopy US		Contract Price
Coll:	I	SEK 80,00
Size & Weight:	L: 250 cm - 0,2 kg	
Packing:	Clear Poly bag - 0,2 kg	
Material:	Plastic	
Light Source:	E27 (big socket). Low-energy 9 Watt bulbs are recommended.	
	505001 White	



Canopy		Contract Price
Coll:	I	SEK 48,00
Size & Weight:	H: 7,7 x Ø: 9 cm - 0,04 kg	
Packing:	Clear Poly bag - 0,04	
Material:	Plastic	
	505011 White	
	505012 Black	5

# 7% rabatt ska dras av på angivna priser

## EDDY EU

Design: Simon Legald, 2018  
Duty Code: 94051050  
Made in: China  
Construction: The table lamp consists of a steel screen with integrated LED light source and a lamp base made of hand turned Italian marble. Lampshade and base meet in a rotation point: a brass ball, which the shade can be tipped around to control the direction of the light. Brass dimmer on top of the lampshade. Textile-covered cord.  
Maintenance: Clean with damp cloth.

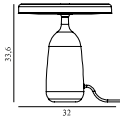

### Eddy Table Lamp EU

Colli: 1  
Size & Weight: H: 33,6 x Ø: 32 cm - 7,8 kg  
Packing: Brown Box - H: 44 x L: 43 x D: 43 cm - 12 kg  
M3: 0,0814  
Material: Pressed Steel, Marble  
Light Source: LED chip (not replaceable). Light source power - 16,5W. LED life span - 25000hrs.

Contract Price  
SEK 6.000,00



502172  
White



502173  
Grey



502174  
Black

## FLOW EU

Design: Andreas Kowalewski, 2016  
Awards: German Design Award Gold, 2018, IF Design Award 2018, Germany & Red Dot Award 2018, Germany  
Duty Code: 94052099  
Made in: China  
Construction: Delivered with 2 m textile cord.  
Maintenance: Clean with damp cloth.



### Flow Table Lamp EU

Colli: 1  
Size & Weight: H: 42 x L: 58 x D: 16 cm - 3,2 kg  
Packing: Brown Box - H: 51 x L: 75 x D: 53 cm - 4,2 kg  
M3: 0,2027  
Material: Powder Coated Metal  
Light Source: SMD 2835 LED chip (not replaceable). Light source power - 5W, whole lamp power: 6.8W. Input voltage: 100-240V, LED part input: 15.1V DC 350mA. Color temperature: 2800-3200K. LED life span - 30000hrs.

Contract Price  
SEK 2.496,00



505053  
White



505054  
Black



505055  
Dark Green

# GRANT EU 7% rabatt ska dras av på angivna priser

Design: Simon Legald, 2018

Duty Code: 94051050

Made in: China

Construction: A ball joint connecting lampshades and arms allows for the lampshades to be positioned in every direction. The arms of the wall lamps can be moved sideways. All lamps in the series have a replaceable LED light source with dispersion lens. The floor lamp, table lamp and wall lamps come with dimmer and the pendants are dimmer compatible. Textile-covered cord.

Maintenance: Clean with damp cloth.

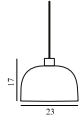

## Grant Pendant EU Ø23

Colli: I  
 Size & Weight: H: 17 x Ø: 23 cm - 1 kg  
 Packing: Brown Box - H: 28,5 x L: 28,5 x D: 20 cm - 2 kg  
 M3: 0,0162  
 Material: Steel, Granite  
 Light Source: LED 5kVWh/10.000h. Bulb is included.

Contract Price  
 SEK 2.000,00



502012  
 Brass



502013  
 Black

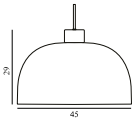

## Grant Pendant EU Ø45

Size & Weight: H: 29 x Ø: 45 cm - 4 kg  
 Packing: Brown Box - H: 54 x L: 54 x D: 37 cm - 5,5 kg  
 M3: 0,1079  
 Material: Steel, Granite  
 Light Source: LED 7kVWh/10.000h. Bulb is included.

Contract Price  
 SEK 4.000,00



502014  
 Brass



502015  
 Black

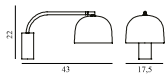

## Grant Wall Lamp EU 43cm

Colli: I  
 Size & Weight: H: 22 x D: 43 x Ø: 17,5 cm - 1,5 kg  
 Packing: Brown Box - H: 46,5 x L: 30 x D: 24,5 cm - 2,5 kg  
 M3: 0,0342  
 Material: Steel, Granite  
 Light Source: LED 4kVWh/10.000h. Bulb is included.

Contract Price  
 SEK 2.800,00



502020  
 Brass



502021  
 Black

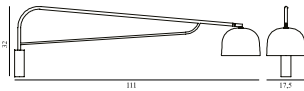

## Grant Wall Lamp EU 111cm

Colli: I  
 Size & Weight: H: 32 x D: 111 x Ø: 17,5 cm - 2,5 kg  
 Packing: Brown Box - H: 117 x L: 39,5 x D: 24 cm - 4,5 kg  
 M3: 0,1109  
 Material: Steel, Granite  
 Light Source: LED 4kVWh/10.000h. Bulb is included.

Contract Price  
 SEK 5.000,00



502022  
 Brass



502023  
 Black

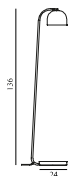

## Grant Floor Lamp EU

Size & Weight: H: 136 x Ø: 24 cm - 6,5 kg  
 Packing: Brown Box - H: 145,5 x L: 39,5 x D: 32 cm - 9,5 kg  
 M3: 0,1839  
 Material: Steel, Granite  
 Light Source: LED 4kVWh/10.000h. Bulb is included.

Contract Price  
 SEK 5.000,00



502018  
 Brass



502019  
 Black

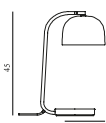

## Grant Table Lamp EU

Size & Weight: H: 45 x Ø: 17,5 cm - 2,5 kg  
 Packing: Brown Box - H: 51,5 x L: 30 x D: 24,5 cm - 4,5 kg  
 M3: 0,0379  
 Material: Steel, Granite  
 Light Source: LED 4kVWh/10.000h. Bulb is included.

Contract Price  
 SEK 2.600,00



502016  
 Brass



502017  
 Black

# HELLO EU 7% rabatt ska dras av på angivna priser

Design: Jonas Wagell, 2012  
 Duty Code: 9405209990  
 Made in: China  
 Construction: Delivered with 4 m textile cord with switch.  
 Maintenance: Clean with damp cloth.

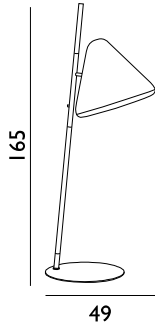

## Hello Floor Lamp EU

Colli: 1  
 Size & Weight: H: 165 x Ø: 49 cm - 11,5 kg  
 Packing: Brown Box - H: 55 x L: 83 x D: 67 cm - 16,9 kg  
 M3: 0,3059  
 Material: Steel, Beech, Acrylic Diffuser  
 Light Source: EU E27 (big socket). Low-energy 9 Watt bulbs are recommended.

Contract Price  
 SEK 5.000,00



# IKONO EU

Design: Simon Legald, 2013  
 Duty Code: 9405109890  
 Made in: China  
 Construction: The light is directed by the top shade while the lower shade ensures anti-dazzle. Delivered with 4 m textile cord and fitting in a matching color. White ceiling canopy is included.  
 Maintenance: Clean with damp cloth.

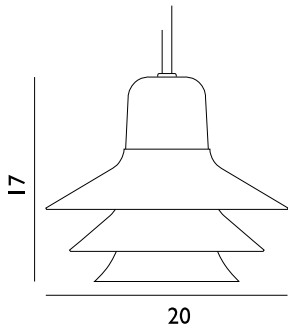

## Ikono Lamp Small EU

Colli: 1  
 Size & Weight: H: 17 x Ø: 20 cm - 1,2 kg  
 Packing: Brown Box - H: 42 x L: 26 x D: 26 cm - 1,7 kg  
 M3: 0,0284  
 Material: Glass, Steel  
 Light Source: EU G9 Halogen (not included). 20 Watt bulbs are recommended.

Contract Price  
 SEK 1.296,00

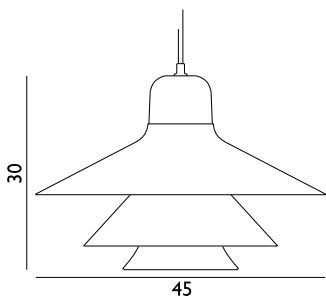
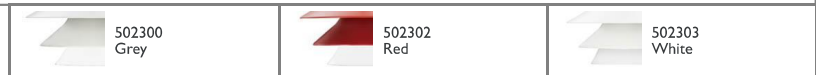

## Ikono Lamp Large EU

Colli: 1  
 Size & Weight: H: 30 x Ø: 45 cm - 3,5 kg  
 Packing: Brown Box - H: 79 x L: 51 x D: 28 cm - 5,1 kg  
 M3: 0,1128  
 Material: Glass, Steel  
 Light Source: EU E27 (big socket). Low-energy 9 Watt bulbs are recommended.

Contract Price  
 SEK 2.496,00





# 7% rabatt ska dras av på angivna priser

## LOCAL EU

Design: Jonas Wagell, 2018  
Duty Code: 94051050  
Made in: China  
Construction: Made of steel with a powder-coating. The lamp is delivered with canopy and 4 m textile covered cord.  
Maintenance: Clean with damp cloth.

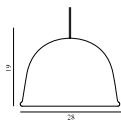

### Local Lamp EU

Colli: 1  
Size & Weight: H: 19 x Ø: 28 cm - 1,25 kg  
Packing: Brown Box - H: 25 x L: 34 x D: 34 cm - 1,9 kg  
Material: Powder Coated Steel  
Light Source: E27 socket. Bulb is not included. The lamp is compatible with bulbs from all energy classes.





Contract Price  
SEK 1.000,00

 502177 White	 502178 Grey	 502179 Black	 502180 Elm Green
---	--	---	---

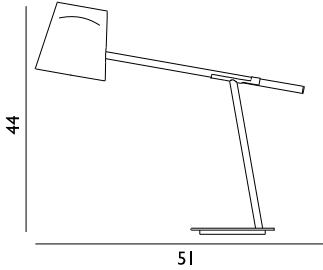
# MOMENTO EU 7% rabatt ska dras av på angivna priser

Design: Daniel Debiassi & Federico Sandri, 2016  
 Duty Code: 94052099  
 Made in: China  
 Construction: Momento is constructed of a powder coated metal body with a plastic lamp shade. Delivered with 2 m textile cord. Switch on lamp shade.  
 Maintenance: Clean with damp cloth.



<b>Momento Table Lamp EU</b>		<i>Contract Price</i>					
Colli:	1	SEK 2.000,00					
Size & Weight:	H: 44 x L: 51 x D: 16,5 cm - 2,2 kg						
Packing:	Brown Box - H: 49 x L: 66 x D: 49 cm - 13,35 kg						
M3:	0,1585						
Material:	Powder Coated Metal						
Light Source:	SMD 2835 LED chip (not replaceable). Light source power - 5,5W, whole lamp power: 7W. Input voltage: 100-240V, LED part input: 15.1V DC 350mA. Color temperature: 2800-3200K. LED life span - 30000hrs.						
	505062 White		505063 Grey		505064 Black		505065 Petrol Green

## PHANTOM EU

Design: Simon Legald, 2018  
 Duty Code: 9403601000  
 Made in: China  
 Construction: The lamp is made by spraying thin threads of flame-retardant resin on a steel frame. Many layers of threads will make the full lampshade, like a silkworm makes its cocoon.

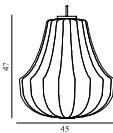

<b>Phantom Lamp EU Small</b>		<i>Contract Price</i>
Colli:	1	SEK 4.496,00
Size & Weight:	H: 47 x Ø: 45 cm - 1,5 kg	
Packing:	Brown Box - H: 66 x L: 55 x D: 55 cm - 6 kg	
M3:	0,1997	
Material:	Environmental Flame-retardant Resin and Steel Frame.	
Light Source:	E27 socket. Bulb is not included. 13W LED/1520 Lumen is recommended. Bulb size must not be larger than L: 11 cm x Ø: 6cm Color temperature: 2700 K	
		
		505038 White

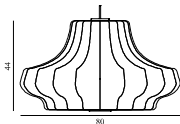

<b>Phantom Lamp EU Medium</b>		<i>Contract Price</i>
Colli:	1	SEK 8.000,00
Size & Weight:	H: 44 x Ø: 80 cm - 2 kg	
Packing:	Brown Box - H: 95 x L: 95 x D: 60 cm - 7,5 kg	
M3:	0,5415	
Material:	Environmental Flame-retardant Resin and Steel Frame.	
Light Source:	E27 socket. Bulb is not included. 13W LED/1520 Lumen is recommended. Bulb size must not be larger than L: 11 cm x Ø: 6cm Color temperature: 2700 K	
		
		505039 White

7% rabatt ska dras av på angivna priser

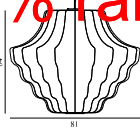

**Phantom Lamp EU Large**

Coll: I  
 Size & Weight: H: 64 x Ø: 81 cm - 2,3 kg  
 Packing: Brown Box - H: 95 x L: 95 x D: 77 cm - 8 kg  
 M3: 0,6949  
 Material: Environmental Flame-retardant Resin and Steel Frame.  
 Light Source: E27 socket. Bulb is not included. 13W LED/1520 Lumen is recommended. Bulb size must not be larger than L:11 cm x Ø:6cm Color temperature: 2700 K

Contract Price  
 SEK 9.000,00



505040  
 White

**RISE EU**

Design: Marianne Andersen, 2016  
 Duty Code: 94052099  
 Made in: China  
 Construction: Delivered with 2 m textile cord with switch.  
 Maintenance: Clean with damp cloth.

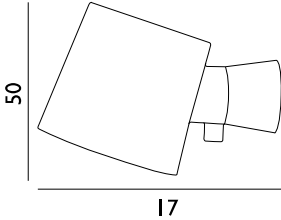

**Rise Wall Lamp EU**

Coll: I  
 Size & Weight: H: 9,7 x L: 17 x Ø: 10 cm - 0,5 kg  
 Packing: Gift Box - H: 12,5 x L: 17 x D: 12 cm  
 Material: Powder Coated Metal, Ash Wood  
 Light Source: EU E14 (small socket). 0,5W bulbs (LED) are recommended.

Contract Price  
 SEK 696,00

 502005 White	 502006 Grey	 502007 Black	 502008 Petrol Green
 502009 Yellow			

**SHELTER EU**

Design: HolmbäckNordentoft, 2013  
 Duty Code: 9405209990  
 Made in: China  
 Construction: Delivered with 2 m textile cord with switch.  
 Maintenance: Clean with damp cloth.

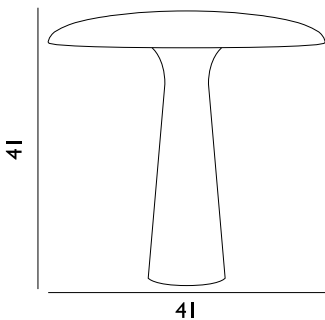

**Shelter Table Lamp EU**

Coll: I  
 Size & Weight: H: 41 x Ø: 41 cm - 3,3 kg  
 Packing: Brown Box - H: 52 x L: 46 x D: 33 cm - 5,7 kg  
 M3: 0,0789  
 Material: Steel  
 Light Source: EU E27 (big socket), 9 Watt low-energy bulbs are recommended.

Contract Price  
 SEK 1.600,00

 505045 Black	 505046 Limestone	 505047 White
---	--	---

**ALUMINUM**

## CLEANING

- Clean with a damp cloth wrung in a solution of water and neutral detergent.
- Avoid using scouring cream or scouring pads as they may scratch the surface.

**CHROME**

## CLEANING

- Clean with a damp cloth wrung in a solution of water and neutral detergent.
- Avoid using scouring cream or scouring pads as they may scratch the surface.

**GLASS**

## CARE

- Be careful with sharp objects as they may scratch the surface.

## CLEANING

- Table tops made of glass should be wiped with a clean, dry cloth.
- To remove grease (fingerprints, etc.), use a glass cleanser.
- Excess water can be removed with a dry cloth. You can then dry polish the glass with a micro-fiber cloth.
- Avoid cleaning with ammonia.
- Never use abrasive cleaners or sharp-edged cleaning tools.

**GRANITE**

Granite distinguishes itself by being resistant to scratches and heat. Each piece of granite is unique with natural variations in the pattern.

## CARE

- For maintenance, use care products specially developed for granite or use a damp cloth wrung in a mix of water and mild soap or soap flakes. This will form a light protective film on the surface.

## CLEANING

- We recommend cleaning with a damp cloth wrung in a mix of water and mild soap or soap flakes. Granite tolerates most cleaning products.

**LACQUERED ABS**

## CLEANING

- Clean with soft damp cloth or nano-cloth.

**LAMINATE**

## CARE

- Never place hot items directly on the laminate.

## CLEANING

- Clean with a damp cloth wrung in a solution of water and all-purpose cleaner or household ammonia. Avoid using abrasive cleaners.
- Remove soap residue immediately afterwards, using a clean, dry cloth.

Stains can be removed gently with a clean, damp cloth or a nano-sponge wrung in warm water with 1 part vinegar to 10 parts water.

**LAMP FOIL**

## CLEANING

- Clean with a duster, a micro-fiber cloth or by carefully using a vacuum cleaner with a soft brush attachment.

**LEATHER**

Normann Copenhagen uses high-quality natural leather from Sørensen Leather. The leather is pleasant to touch, with a uniform grain pattern spanning over the entire hide. If you look after the leather, you can preserve its natural beauty and make it look even more luscious over time.

## CARE

- Avoid placing the leather in direct sunlight or extreme heat.
- Avoid soaking the leather or any contact with sharp objects.
- Absorb any spills immediately, using a clean, dry cloth.
- Dust and clean regularly according to instructions below.

## CLEANING

- Dust using a vacuum cleaner with a soft brush.
- Clean using the foam from soap flakes. Use a 1/2 deciliter of soap flakes to 1 liter of water. Whip the soap flakes into hot water. When the water becomes room temperature, the foam must be applied all over the leather with a soft cloth. Only use the foam and avoid soaking the leather. When the leather is dry, polish it with a soft, dry cotton cloth.
- Never use detergents, ammonia, oils, polish, varnish, etc.

**LINOLEUM**

Linoleum is a durable material made of a combination of linseed oil, resin, limestone, saw dust, and natural pigments. It is known to have anti-bacterial and self-healing properties. We use Forbo's furniture linoleum, which is comfortable to touch and has a beautiful matte finish.

## CARE

- We recommend using coasters under damp or colored items to avoid permanent stains.
- Never place hot items directly on the linoleum table top.
- Use linoleum care regularly to maintain the surface.
- Wipe any spills as soon as they occur to avoid them from soaking in.

## CLEANING

- Only use a PH-neutral cleaning product on linoleum as alkaline detergents may deplete the linoleum.
- Clean with a damp cloth wrung in a solution of water and a detergent made especially for linoleum. Remove soap residue immediately afterwards, using a clean, dry cloth.
- Stains can be removed carefully using white spirit (minerals turpentine) or a damp nano-sponge with warm water or a linoleum product. Please note that the nano-sponge should not be used when dry.

## MARBLE

Marble has a fine hard surface with a beautiful natural pattern. Each piece of stone is unique in color and composition.

### CARE

- Wipe any spills as soon as they occur to avoid them from soaking in.
- Marble table tops can be maintained with mild soap or soap flakes, which forms a light protective film on the surface. Use mild soap or soap flakes over time to make the surface more resistant to spots and give it a silky matte look.

### CLEANING

- Clean using a cleaning soap for all types of natural stone. Avoid the use of all-purpose cleaners and other degreasing detergents as well as substances containing acids.

## POWDERCOATED STEEL

### CARE

- Do not expose to extreme UV light to prevent color from fading.

### CLEANING

- Clean with a damp cloth wrung in a solution of water and neutral detergent.
- Avoid using scouring cream or scouring pads as they may scratch the surface

## RUGS

### CLEANING

- Frequent vacuuming is recommended to preserve color and appearance.
- Rugs can be dry cleaned.

## PAPER CORD

### CARE

- Avoid getting the paper cord wet as the color may rub off.

### CLEANING

- Clean with a clean dry cloth.

## PUR FOAM

### CLEANING

- Clean with a damp cloth.

## TERRAZZO

Normann Copenhagen uses a terrazzo made of concrete and marble chips by original Italian technique. Each terrazzo sheet has a unique mix of flaked stone with distinctive shapes and colors.

### CARE

- Wipe any spills as soon as they occur to avoid them from soaking in.
- For maintenance, clean with a damp cloth wrung in a solution of water and mild soap or soap flakes. Afterwards, wipe the surface, using a clean, dry cloth.

### CLEANING

- For daily cleaning, clean with damp cloth. Avoid the use of all-purpose cleaners and other degreasing detergents as well as substances containing acids.

## PLASTIC - POLYPROPYLENE (PP)

### CARE

- Avoid placing the furniture in direct sunlight or close to strong heat sources.

### CLEANING

- Clean the surface using a damp cloth wrung in a solution of water and neutral detergent. Afterwards, wipe the surface using a clean dry cloth.

## RUBBER FABRIC

### CLEANING

- Clean with a damp cloth.

## TEXTILE

Normann Copenhagen's upholstered furniture is made with high quality textiles from some of the world's leading fabric suppliers. Textiles are selected based on their look, feel and durability.

### CARE

- Avoid long-term exposure to direct sunlight and other light sources as the textile might inevitably fade.
- Rope sofa: Adjust your sofa upon receipt. Straighten fabric on all modules and move piping to the right position. Press fabric down between each of the modules and between the backrest and the seat.

### CLEANING

- Clean with textile or upholstery cleaner.
- Frequent vacuuming with a soft fitting is recommended to preserve color and appearance.
- Stains should be removed immediately to avoid permanent damage.

7% rabatt ska dras av på angivna priser

**WOOD - VENEER, SOLID,  
LACQUERED, STAINED**

We work with many kinds of wood depending on the design and purpose, but always with a focus on creating high-quality furniture. We only use wood from sustainable production for our furniture.

**CARE**

- Wipe any spills as soon as they occur to avoid them soaking in.
- Never place hot items directly on the table top.

**CLEANING**

- Clean with a damp cloth.
- Never use abrasive cleaners, steel wool or polish.

**WOOD-PLASTIC-COMPOSITE**

**CARE**

- Be careful with sharp objects as they may scratch the surface.

**CLEANING**

- Clean with soft damp cloth or nano-cloth.

# 7% rabatt ska dras av på angivna priser

## Välkommen till Skandinaviens ledande inredningsföretag

Vi tillhandahåller behovsanpassad inredning utifrån kundens förutsättningar beträffande design, profil, funktion, ergonomi och ekonomi. Vi arbetar med kontor, hotell och restaurang, skola och utbildning samt vård och omsorg.

## Input sedan 1987

Att gestalta en miljö som människor kan trivas och jobba effektivt i är ett hantverk som handlar om lika delar planering och finurlighet. Sedan 1987 har vi utvecklats till en komplett leverantör av inredning; allt från projektledning, upphandling till leverans, montering och efterservice. Läs mer om oss på [www.inputinterior.se](http://www.inputinterior.se).

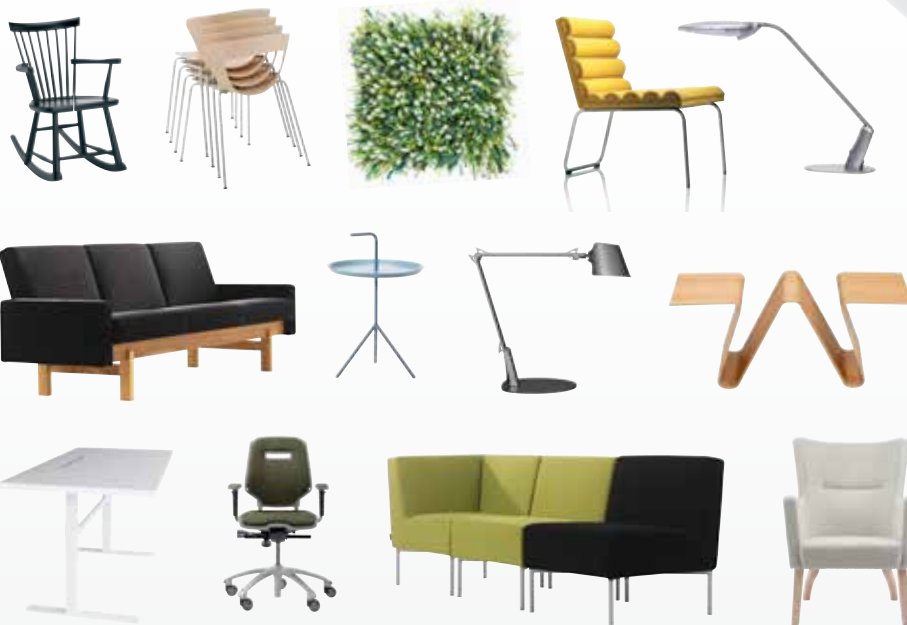

**En kund · ett datum · en leverans**