

20% rabatt ska dras av på angivna priser



## Statligt ramavtal - Möbler och inredning

---

Delområde: Inredningsarmaturer

Dnr 23.3.-8004-18:034

Produktlista nr: 1

**Lyfa**

**2022**



# 20% rabatt ska dras av på angivna priser

## Kontaktuppgifter

---

### Lokala kontor och utställningar:

#### Stockholm

Regeringsgatan 66  
103 88 Stockholm

Peter Almgren  
076-533 50 43  
peter.almgren@senab.com

#### Göteborg

Fiskhamngatan 6C  
414 58 Göteborg

Martin Oskarsson  
076-533 50 10  
martin.oskarsson@senab.com

#### Malmö

Fersens väg 3  
211 42 Malmö

Niclas Mattsson  
070-372 23 05  
niclas.mattsson@senab.com

#### Uppsala

St:Olofsgatan 10B  
753 12 Uppsala

Stina Lawyer  
076-533 50 58  
stina.lawyer@senab.com

#### Helsingborg

Järnvägsgatan 57  
252 18 Helsingborg

Bosse Weberg  
076-533 53 41  
bosse.weberg@senab.com

#### Umeå

Storgatan 41  
903 25 Umeå

Frida Bergström  
072-050 95 84  
frida.bergstrom@senab.com

#### Luleå

Timmermansgatan 4  
972 33 Luleå

Helena Öberg  
076-502 02 05  
helena.oberg@senab.com

#### Gävle

Nygatan 28  
803 11 Gävle

Cecilia Sjöblom  
076-501 10 93  
cecilia.sjoblom@senab.com

#### Hedemora

Kålgårdsvägen 12  
776 93 Hedemora

Michael Andersson  
076-501 10 95  
michael.andersson@senab.com

#### Edsbyn

Karls väg 2  
828 25 Edsbyn

Ronny Fagerhov  
070-224 67 44  
ronny.fagerhov@senab.com

#### Jönköping

Västra Storgatan 6  
553 15 Jönköping

Pia Heldt  
076-533 51 57  
pia.heldt@senab.com

#### Norrköping

Sankt Persgatan 19  
601 86 Norrköping

Jan Magnusson  
076-945 19 36  
jan.magnusson@senab.com

#### Sundsvall

Thulegatan 25  
852 36 Sundsvall

Jonas Westerlund  
076-502 02 04  
jonas.westerlund@senab.com



20% rabatt ska dras av på angivna priser





20% rabatt ska dras av på angivna priser



**Illuminating traditions**

# 20% rabatt ska dras av på angivna priser

## Collection 2021

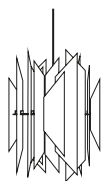

### DIVAN 2

1962

PAGE: 3

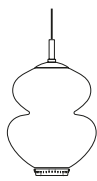

### PEANUT

1946

PAGE: 4

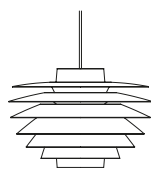

### VERONA

1968

PAGE: 5



### ERGO

1971

PAGE: 11



### NINOTCHKA

1954

PAGE: 6

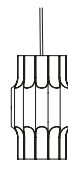

### PAN

1970

PAGE: 9

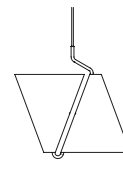

### MOSAIK

1959

PAGE: 7-8

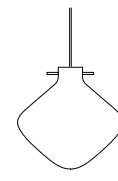

### REPOSE

2021

PAGE: 2

Pendants

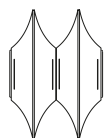

### GOTHIC

1970

PAGE: 10



### PAN

1970

PAGE: 9

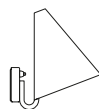

### MOSAIK

1959

PAGE: 7-8

Wall lamps

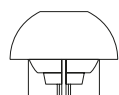

### ERGO

1971

PAGE: 11

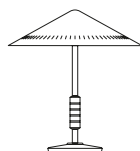

### GOVERNOR

1956

PAGE: 12



### MOSAIK

1959

PAGE: 7-8



### REPOSE

2021

PAGE: 2

Table lamps

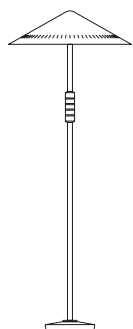

### GOVERNOR

1956

PAGE: 12



### MOSAIK

1959

PAGE: 7-8

Floor lamps

# 20% rabatt ska dras av på angivna priser







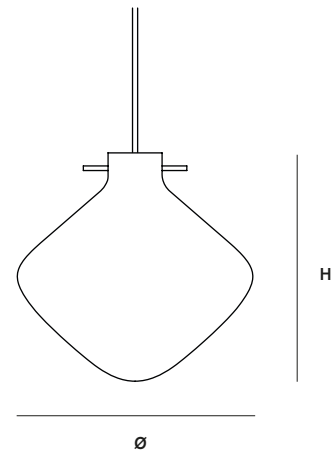

## REPOSE

by GamFratesi <sup>2021</sup>

REPOSE is a new series of opal glass lamps epitomized by GamFratesi's passion for craftsmanship, contrasts and refined aesthetic. Its strong sense of character is achieved by the poetic balance point of the thin line crossing the top of the organic shades. While exploring the contrasts between linearity and natural plasticity of glass, a clear silhouette of the REPOSE series arose. Designed to provide a calm atmosphere with its diffused light, graphic expression and soft shapes.



ALL PRICES ARE **RRP EX VAT**

			DIMENSIONS	COLOUR	MATERIAL	CORD	SOCKET	WEIGHT	DKK	SEK	NOK	EUR	GBP
<b>NEW</b>		REPOSE I <b>175</b> 191017514	Ø 175 H 118	Black	Metal Opal glass	Steel wire 3 m black textile	G9 Max 60W	0,7 kg	1.999	2.739	2.999	269	269
<b>NEW</b>		REPOSE I <b>175</b> 191017515	Ø 175 H 118	Brass	Metal Opal glass	Steel wire 3 m white textile	G9 Max 60W	0,7 kg	1.999	2.739	2.999	269	269
<b>NEW</b>		REPOSE I <b>260</b> 191026014	Ø 260 H 252	Black	Metal Opal glass	Steel wire 3 m black textile	E14 Max 60W	1,5 kg	2.559	3.509	3.799	349	329
<b>NEW</b>		REPOSE I <b>260</b> 191026015	Ø 260 H 252	Brass	Metal Opal glass	Steel wire 3 m white textile	E14 Max 60W	1,5 kg	2.559	3.509	3.799	349	329
<b>NEW</b>		REPOSE I <b>400</b> 191040014	Ø 400 H 270	Black	Metal Opal glass	Steel wire 3 m black textile	E27 Max 60W	3,3 kg	3.599	4.929	5.199	489	449
<b>NEW</b>		REPOSE I <b>400</b> 191040015	Ø 400 H 270	Brass	Metal Opal glass	Steel wire 3 m white textile	E27 Max 60W	3,3 kg	3.599	4.929	5.199	489	449
<b>NEW</b>		REPOSE I <b>TABLE</b> 192017514	Ø 175 H 145	Black	Metal Opal glass	2,5 m black textile	G9 Max 60W	0,8 kg	1.439	1.969	2.199	199	199
<b>NEW</b>		REPOSE I <b>TABLE</b> 192017514	Ø 175 H 145	Brass	Metal Opal glass	2,5 m white textile	G9 Max 60W	0,8 kg	1.439	1.969	2.199	199	199

# 20% rabatt ska dras av på angivna priser







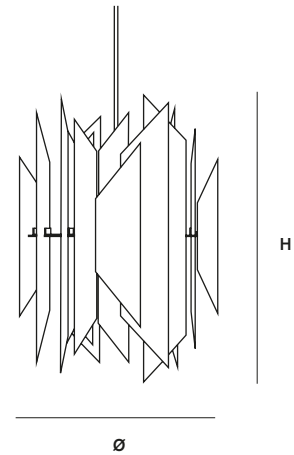

## DIVAN 2

by Simon P. Henningsen <sup>1962</sup>

In 1962, Simon P. Henningsen unveiled a new pendant purposely designed for the Tivoli's famous restaurant, Divan 2. The rooms offered spectacular views over the garden lake and at night, the pendant's mirrored surfaces would catch the light from the famous fireworks and the lake. The success of the DIVAN 2 pendant went well beyond Copenhagen's beloved amusement park as LYFA started offering the lamp for the general public. DIVAN 2 was bestowed with several Danish and international design awards. In 1963, it was even exhibited at the Louvre in Paris.



ALL PRICES ARE **RRP EX VAT**

		DIMENSIONS	COLOUR	MATERIAL	CORD	SOCKET	WEIGHT	DKK	SEK	NOK	EUR	GBP
	DIVAN 2   <b>245</b> 181024501	Ø 245 H 319	Original	Stainless steel	3 m black textile	E27 Max 60W	2,5 kg	4.799	6.579	6.899	639	619
	DIVAN 2   <b>245</b> 181024510	Ø 245 H 319	Brass	Solid brass	3 m white textile	E27 Max 60W	2,7 kg	4.799	6.579	6.899	639	619
	DIVAN 2   <b>400</b> 181040001	Ø 400 H 521	Original	Stainless steel	Steel wire 3 m black textile	E27 Max 60W	8,4 kg	14.399	19.729	20.299	1.919	1.769
	DIVAN 2   <b>400</b> 181040010	Ø 400 H 521	Brass	Solid brass	Steel wire 3 m black textile	E27 Max 60W	9 kg	14.399	19.729	20.299	1.919	1.769
	DIVAN 2   <b>550</b> 181055001	Ø 550 H 717	Original	Stainless steel	Steel wire 6 m black textile	E27 Max 60W	15,2 kg	33.599	46.029	46.999	4.479	4.089
	DIVAN 2   <b>550</b> 181055010	Ø 550 H 717	Brass	Solid brass	Steel wire 6 m white textile	E27 Max 60W	20,3 kg	33.599	46.029	46.999	4.479	4.089
	DIVAN 2   <b>700</b> 181070001	Ø 700 H 913	Original	Stainless steel	Steel wire 6 m black textile	E27 Max 60W	23,6 kg	51.999	71.239	72.499	6.929	6.309
	DIVAN 2   <b>700</b> 181070010	Ø 700 H 913	Brass	Solid brass	Steel wire 6 m white textile	E27 Max 60W	28,4 kg	51.999	71.239	72.499	6.929	6.309

# 20% rabatt ska dras av på angivna priser

## PEANUT

by Bent Karlby <sup>1946</sup>

The PEANUT lamp was introduced in 1946 at a time when fluorescent lighting was gaining widespread popularity across society. But like many of his fellow contemporaries, Bent Karlby shared a strong distaste for this harsh and cold lighting. With its organic shapes and elegant brass detailing - completed with Karlby's hallmark peepholes - the PEANUT lamp became his solution for soft and pleasant room lighting that was equally appealing to look at. The curvy-shaped shade is crafted from mouth-blown opalized glass, complemented by an elegant brass top and bottom piece.

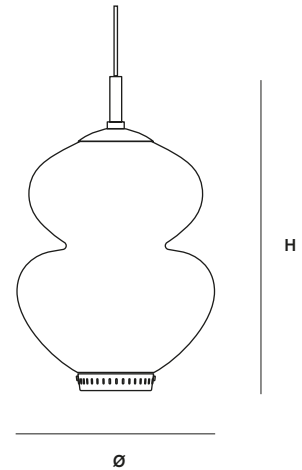

ALL PRICES ARE **RRP EX VAT**

		DIMENSIONS	COLOUR	MATERIAL	CORD	SOCKET	WEIGHT	DKK	SEK	NOK	EUR	GBP
	PEANUT I <b>175</b> 151017511	Ø 175 H 290	White/ Brass	Opal glass Solid brass	3 m white textile	E14 Max 40W	1 kg	2.239	3.069	3.399	299	309
	PEANUT I <b>250</b> 151025011	Ø 250 H 420	White/ Brass	Opal glass Solid brass	3 m white textile	E27 Max 60W	2,3 kg	2.799	3.839	4.099	369	379
	PEANUT I <b>400</b> 151040011	Ø 400 H 620	White/ Brass	Opal glass Solid brass	Steel wire 6 m white textile	E27 Max 60W	4,2 kg	5.599	7.669	7.999	749	709



# 20% rabatt ska dras av på angivna priser

## VERONA

by Sven Middelboe <sup>1968</sup>

A sophisticated 8-shade pendant that serves a soft, glare-free lighting with timeless grace and simplicity. When lit, the spherical pendant beautifully self-illuminates, making for a striking display in itself. When introduced in 1968, Sven Middelboe's VERONA series grew into the most popular design of his career. VERONA was the ultimate result of many years of experimentation with different shade constructions.

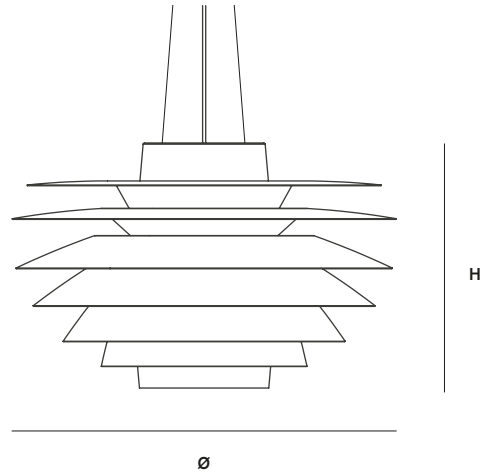

ALL PRICES ARE **RRP EX VAT**

			DIMENSIONS	COLOUR	MATERIAL	CORD	SOCKET	WEIGHT	DKK	SEK	NOK	EUR	GBP
<b>NEW</b>		VERONA   <b>175</b> 171017503	Ø 175 H 125	White	Matt painted aluminium	3 m white textile	G9 Max 40W	0,7 kg	1.999	2.739	2.999	269	279
<b>NEW</b>		VERONA   <b>250</b> 171025003	Ø 250 H 174	White	Matt painted aluminium	3 m white textile	E14 Max 60W	1,1 kg	2.799	3.839	4.099	369	379
<b>NEW</b>		VERONA   <b>320</b> 171032003	Ø 320 H 221	White	Matt painted aluminium	3 m white textile	E27 Max 75W	1,8 kg	3.599	4.929	5.299	479	469
		VERONA   <b>400</b> 171040003	Ø 400 H 276	White	Matt painted aluminium	3 m white textile	E27 Max 60W	3,8 kg	8.399	11.509	11.899	1.119	1.049
		VERONA   <b>400</b> 171040010	Ø 400 H 276	Brass	Solid brass	Steel wire 3 m white textile	E27 Max 60W	6,5 kg	14.399	19.729	20.299	1.919	1.769
		VERONA   <b>720</b> 171072003	Ø 720 H 459	White	Matt painted aluminium	Steel wire 6 m white textile	E27 Max 60W	13,4 kg	21.599	29.589	30.299	2.879	2.639
		VERONA   <b>720</b> 171072010	Ø 720 H 459	Brass	Solid brass	Steel wire 6 m white textile	E27 Max 60W	22,7 kg	46.399	63.569	64.699	6.189	5.629

# 20% rabatt ska dras av på angivna priser







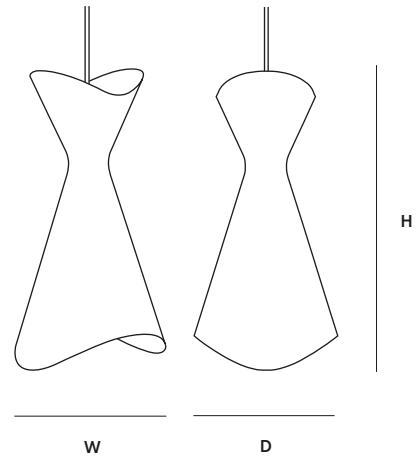

## NINOTCHKA

by Bent Karlby <sup>1954</sup>

When giving shape to the NINOTCHKA pendant, Bent Karlby took note of an eye-catching hat, worn by the Swedish Hollywood star Greta Garbo in her 1939 film, Ninotchka. Art, fashion and popular culture have a long tradition of inspiring each other and this lamp is yet another great example. The pendant is a genuine and easily recognizable design icon. The organic body with its asymmetrical drapes ensures functional direct downlight and an ambient uplight.



ALL PRICES ARE **RRP EX VAT**

		DIMENSIONS	COLOUR	MATERIAL	CORD	SOCKET	WEIGHT	DKK	SEK	NOK	EUR	GBP
	NINOTCHKA   <b>195</b> 111019502	W 195 D 170 H 350	Black	Matt painted steel	3 m black textile	E27 Max 40W	0,7 kg	2.079	2.849	3.099	279	289
	NINOTCHKA   <b>195</b> 111019503	W 195 D 170 H 350	White	Matt painted steel	3 m white textile	E27 Max 40W	0,7 kg	2.079	2.849	3.099	279	289
	NINOTCHKA   <b>195</b> 111019504	W 195 D 170 H 350	Red	Matt painted steel	3 m black textile	E27 Max 40W	0,7 kg	2.079	2.849	3.099	279	289
	NINOTCHKA   <b>275</b> 111027502	W 275 D 239 H 494	Black	Matt painted steel	3 m black textile	E27 Max 60W	0,9 kg	2.799	3.839	4.099	369	379
	NINOTCHKA   <b>275</b> 111027503	W 275 D 239 H 494	White	Matt painted steel	3 m white textile	E27 Max 60W	0,9 kg	2.799	3.839	4.099	369	379
	NINOTCHKA   <b>275</b> 111027504	W 275 D 239 H 494	Red	Matt painted steel	3 m black textile	E27 Max 60W	0,9 kg	2.799	3.839	4.099	369	379
	NINOTCHKA   <b>425</b> 111042502	W 425 D 370 H 764	Black	Matt painted steel	3 m black textile	E27 Max 60W	2 kg	4.399	6.029	6.399	589	569
	NINOTCHKA   <b>425</b> 111042503	W 425 D 370 H 764	White	Matt painted steel	3 m white textile	E27 Max 60W	2 kg	4.399	6.029	6.399	589	569
	NINOTCHKA   <b>425</b> 111042504	W 425 D 370 H 764	Red	Matt painted steel	3 m black textile	E27 Max 60W	2 kg	4.399	6.029	6.399	589	569

# 20% rabatt ska dras av på angivna priser







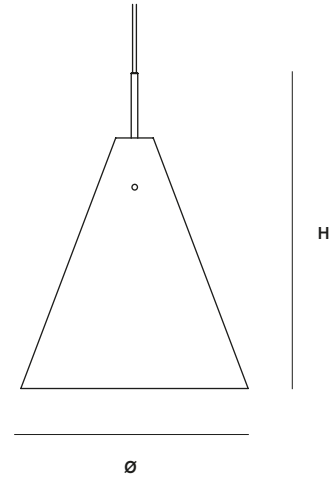



## MOSAIK

by Bent Karlby 1959

The MOSAIK collection is an ingenious lighting system based on a simple, geometrical design principle. At the heart of the system is the iconic conical lampshade and a connecting brass tube that allow for several surprising lamp designs. At the time of its release, MOSAIK was a bold and playful piece of lighting design intended for the modern home. And even today, Bent Karlby's uplifting collection remains as original and contemporary as ever.











ALL PRICES ARE **RRP EX VAT**

		DIMENSIONS	COLOUR	MATERIAL	CORD	SOCKET	WEIGHT	DKK	SEK	NOK	EUR	GBP
	MOSAIK I <b>170</b> 101017003	Ø 170 H 291	White	Matt painted steel and solid brass	3 m white textile	E27 Max 40W	0,6 kg	1.599	2.189	2.499	209	229
	MOSAIK I <b>170</b> 101017002	Ø 170 H 291	Black	Matt painted steel and solid brass	3 m black textile	E27 Max 40W	0,6 kg	1.599	2.189	2.499	209	229
	MOSAIK I <b>250</b> 101025003	Ø 250 H 380	White	Matt painted steel and solid brass	3 m white textile	E27 Max 60W	1 kg	2.079	2.899	3.199	279	289
	MOSAIK I <b>250</b> 101025002	Ø 250 H 380	Black	Matt painted steel and solid brass	3 m black textile	E27 Max 60W	1 kg	2.079	2.899	3.199	279	289
	MOSAIK I <b>400</b> 101040003	Ø 400 H 447	White	Matt painted steel and solid brass	3 m white textile	E27 Max 60W	1,3 kg	3.679	5.039	5.399	489	479
	MOSAIK I <b>400</b> 101040002	Ø 400 H 447	Black	Matt painted steel and solid brass	3 m black textile	E27 Max 60W	1,3 kg	3.679	5.039	5.399	489	479
	MOSAIK <b>UP/DOWN</b> 101025003-D1	W 415 H 402	White	Matt painted steel and solid brass	3 m white textile	2 x E27 Max 60W	1,8 kg	3.359	4.599	4.899	449	439
	MOSAIK <b>UP/DOWN</b> 101025002-D1	W 415 H 402	Black	Matt painted steel and solid brass	3 m black textile	2 x E27 Max 60W	1,8 kg	3.359	4.599	4.899	449	439
	MOSAIK <b>SIDEBYSIDE II</b> 101025003-D2	W 520 H 362	White	Matt painted steel and solid brass	3 m white textile	2 x E27 Max 60W	1,9 kg	3.599	4.929	5.299	479	469
	MOSAIK <b>SIDEBYSIDE II</b> 101025002-D2	W 520 H 362	Black	Matt painted steel and solid brass	3 m black textile	2 x E27 Max 60W	1,9 kg	3.599	4.929	5.299	479	469

# 20% rabatt ska dras av på angivna priser

ALL PRICES ARE **RRP EX VAT**

		DIMENSIONS	COLOUR	MATERIAL	CORD	SOCKET	WEIGHT	DKK	SEK	NOK	EUR	GBP
	MOSAIK <b>SIDEBYSIDE III</b> 101025003-T1	W 791 H 362	White	Matt painted steel and solid brass	3 m white textile	3 x E27 Max 60W	3,2 kg	4.799	6.579	6.899	639	619
	MOSAIK <b>SIDEBYSIDE III</b> 101025002-T1	W 791 H 362	Black	Matt painted steel and solid brass	3 m black textile	3 x E27 Max 60W	3,2 kg	4.799	6.579	6.899	639	619
	MOSAIK I <b>WALL</b> 103017003	D 214 H 235	White	Matt painted steel and solid brass	2,5 m white plastic	E27 Max 40W	0,7 kg	1.919	2.629	2.899	259	269
	MOSAIK I <b>WALL</b> 103017002	D 214 H 235	Black	Matt painted steel and solid brass	2,5 m white plastic	E27 Max 40W	0,7 kg	1.919	2.629	2.899	259	269
	MOSAIK I <b>TABLE</b> 102017003	W 170 H 474	White	Matt painted steel and solid brass	2 m white plastic	E27 Max 40W	3,6 kg	2.399	3.289	3.599	319	329
	MOSAIK I <b>TABLE</b> 102017002	W 170 H 474	Black	Matt painted steel and solid brass	2 m white plastic	E27 Max 40W	3,6 kg	2.399	3.289	3.599	319	329
	MOSAIK I <b>FLOOR</b> 104025002	W 250 H 1350	White	Matt painted steel and solid brass	2 m white plastic	E27 Max 60W	7,5 kg	3.839	5.259	5.599	509	499
	MOSAIK I <b>FLOOR</b> 104025002	W 250 H 1350	Black	Matt painted steel and solid brass	2 m white plastic	E27 Max 60W	7,5 kg	3.839	5.259	5.599	509	499

# 20% rabatt ska dras av på angivna priser

## PAN

by Bent Karlby <sup>1970</sup>

The PAN series is a beautiful example of Bent Karlby's unique talent for capturing the zeitgeist of an area and turning it into designs that would come to transcend their inspiration. The monochrome surfaces of anodized aluminium transform the PAN series into contemporary design pieces for modern living. The iconic pendant is crafted from 12 polished aluminium pipes. While elegantly illuminating its exteriors through its open pipes, the pendant provides downlight and subtle ambient lighting through its open top.

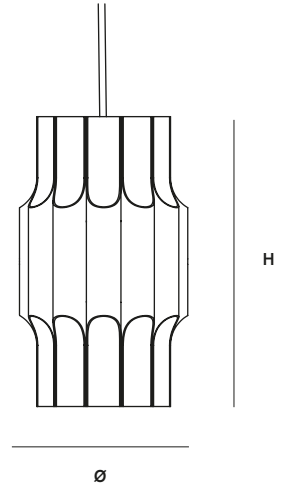

ALL PRICES ARE **RRP EX VAT**



		DIMENSIONS	COLOUR	MATERIAL	CORD	SOCKET	WEIGHT	DKK	SEK	NOK	EUR	GBP
	PAN I <b>190</b> 131019009	Ø 190 H 320	Aluminium	Natural matt anodized aluminium	3 m white textile	E27 Max 60W	1,4 kg	3.359	4.599	4.899	449	439



	PAN I <b>WALL 50</b> 133005009	W 50 H 600	Aluminium	Natural matt anodized aluminium	2,5 m white plastic	2 x E14 Max 40W	0,5 kg	1.839	2.519	2.799	249	259
--	-----------------------------------	---------------	-----------	---------------------------------------	---------------------------	--------------------	--------	-------	-------	-------	-----	-----



	PAN I <b>WALL 95</b> 133095009	W 95 H 360	Aluminium	Natural matt anodized aluminium	2,5 m white plastic	E27 Max 40W	0,5 kg	1.999	2.739	2.999	269	279
--	-----------------------------------	---------------	-----------	---------------------------------------	---------------------------	----------------	--------	-------	-------	-------	-----	-----

20% rabatt ska dras av på angivna priser



## GOTHIC

by Bent Karlby <sup>1970</sup>

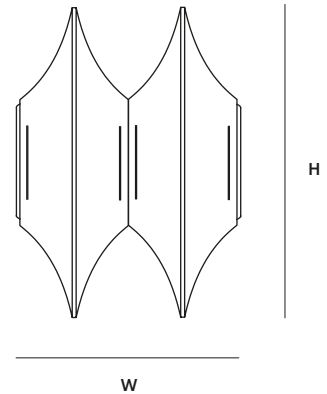
GOTHIC is a distinctive wall lamp designed by Bent Karlby in 1970. Quite surprisingly, only limited information still exists about the series, making GOTHIC an intriguing bit of Danish design mystery. The name was a reference by Karlby to the gothic architectural style that flourished throughout Europe from the 12th to the 16th century, which was characterized by tall narrow structures with pointed arches. The open top allows for upward lighting that leaves a striking pattern on the wall. Through the narrow peepholes - one of Karlby's hallmarks - a small stream of light flows out and onto the curved brass shades.



ALL PRICES ARE **RRP EX VAT**

		DIMENSIONS	COLOUR	MATERIAL	CORD	SOCKET	WEIGHT	DKK	SEK	NOK	EUR	GBP
	GOTHIC I 143010410	W 104 H 280	Brass	Solid brass	2,5 m white plastic	G9 Max 28W	0,7 kg	2.319	3.179	3.499	309	319
	GOTHIC II 143020610	W 206 H 280	Brass	Solid brass	2,5 m white plastic	2 x G9 Max 28W	1 kg	3.199	4.389	4.699	429	419



# 20% rabatt ska dras av på angivna priser



## ERGO

by Bent Karlby <sup>1971</sup>

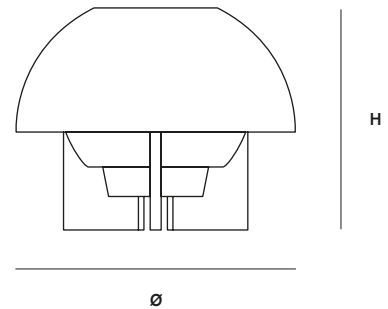
True to its 1970s space-age heritage, the first ERGO lamps came in popping colours and were made entirely from plastic. While retaining its characteristic design language, ERGO has grown into a premium piece of lighting design. The plastic materials have now given way for a three-layered opal glass core and a coloured glass shade - bringing a soft ambient lighting to its surroundings while emitting subtle, pleasant downlight.



ALL PRICES ARE **RRP EX VAT**

		DIMENSIONS	COLOUR	MATERIAL	CORD	SOCKET	WEIGHT	DKK	SEK	NOK	EUR	GBP
	ERGO I <b>250</b> 121025005	Ø 250 H 170	Grey	White opal/ coloured glass	3 m white textile	E27 Max 40W	1,9 kg	2.559	3.509	3.799	339	349
	ERGO I <b>250</b> 121025007	Ø 250 H 170	Sand	White opal/ coloured glass	3 m white textile	E27 Max 40W	1,9 kg	2.559	3.509	3.799	339	349
	ERGO I <b>TABLE</b> 122025005	Ø 250 H 200	Grey	White opal/ coloured glass   Walnut	2 m white plastic	E27 Max 40W	2 kg	2.959	4.059	4.399	399	389
	ERGO I <b>TABLE</b> 122025007	Ø 250 H 200	Sand	White opal/ coloured glass   Oak	2 m white plastic	E27 Max 40W	2 kg	2.959	4.059	4.399	399	389

20% rabatt ska dras av på angivna priser



## GOVERNOR

by Bent Karlby <sup>1956</sup>

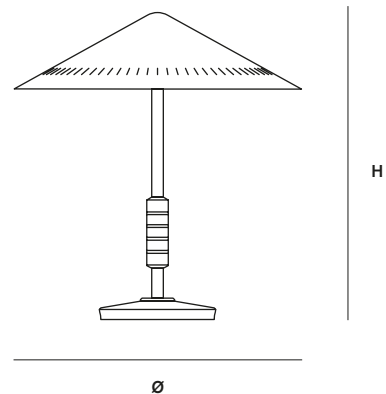
GOVERNOR is a sophisticated mid-century lamp from 1956 that proved to carry an enduring appeal with design lovers around the world. This lamp radiates a certain international flair. It is confident and a premium piece of lighting design that still has the power to impress. GOVERNOR is crafted from solid brass and walnut wood, providing efficient downlight while giving a pleasantly diffused light from the reflective brass shade. When lit, the peepholes around the edge form a decorative light pattern.



ALL PRICES ARE **RRP EX VAT**

		DIMENSIONS	COLOUR	MATERIAL	CORD	SOCKET	WEIGHT	DKK	SEK	NOK	EUR	GBP
	GOVERNOR <b>TABLE</b> 162040510	Ø 405 H 454	Brass	Solid brass Walnut	2 m black plastic	2 x E27 Max 60W	3,9 kg	5.199	7.119	7.499	689	659
	GOVERNOR <b>FLOOR</b> 164040510	Ø 405 H 1300	Brass	Solid brass Walnut	2 m black plastic	2 x E27 Max 60W	7,9 kg	7.199	9.859	10.299	959	909

20% rabatt ska dras av på angivna priser



Experience our lighting universe

WEBSITE

**LYFA.COM**

Worldwide  
shipping

OFFICE AND SHOWROOM

**RYESGADE 28, 2. TV**

8000 Aarhus  
Denmark

SHOWROOM CPH  
at **BRDR. KRÜGER**

**BREDGADE 28**

1260 Copenhagen  
Denmark

SOCIAL MEDIA

**@LYFA**

Instagram  
Facebook  
LinkedIn  
Pinterest

20% rabatt ska dras av på angivna priser



**PRICE LIST 2021**

Building on proud traditions tracing back to 1903



**LYFA.COM**

INFO@LYFA.COM

+45 88 44 44 10

20% rabatt ska dras av på angivna priser

Stockholm  
Luleå  
Sundsvall

Göteborg  
Gävle

Malmö  
Hedemora

Uppsala  
Edsbyn

Helsingborg  
Jönköping

Umeå  
Norrköping

**SENAB**  
*space for big ideas*