

24% rabatt ska dras av på angivna priser



## Statligt ramavtal - Möbler och inredning

---

Delområde: Inredningsarmaturer

Dnr 23.3.-8004-18:034

Produktlista nr: 4

**Muuto**

**2023**



# 24% rabatt ska dras av på angivna priser

## Kontaktuppgifter

---

### Lokala kontor och utställningar:

#### Stockholm

Regeringsgatan 66  
103 88 Stockholm

Peter Almgren  
076-533 50 43  
peter.almgren@senab.com

#### Göteborg

Fiskhamnsgatan 6C  
414 58 Göteborg

Anna Wennberg  
076-533 51 44  
anna.wennberg@senab.com

#### Malmö

Fersens väg 3  
211 42 Malmö

Magdalena Andersson  
076-535 75 87  
magdalena.andersson@senab.com

#### Uppsala

Stationsgatan 32 C  
753 40 Uppsala

Linnéa Hempel  
076-195 39 86  
linnea.hempel@senab.com

#### Helsingborg

Järnvägsgatan 57  
252 18 Helsingborg

Christopher Lundin  
076-533 50 02  
christopher.lundin@senab.com

#### Umeå

Storgatan 41  
903 25 Umeå

Patrik Karlsson  
070 654 0066  
patrik.karlsson@senab.com

#### Gävle

Nygatan 28  
803 11 Gävle

Cecilia Sjöblom  
076-501 10 93  
cecilia.sjoblom@senab.com

#### Hedemora

Åsgatan 68  
776 30 Hedemora

Michael Andersson  
076-501 10 95  
michael.andersson@senab.com

#### Edsbyn

Karls väg 2  
828 25 Edsbyn

Ronny Fagerhov  
070-224 67 44  
ronny.fagerhov@senab.com

#### Jönköping

Västra Storgatan 19A  
553 15 Jönköping

Pia Heldt  
076-533 51 57  
pia.heldt@senab.com

#### Sundsvall

Storgatan 4  
852 30 Sundsvall

Jonas Westerlund  
076-502 02 04  
jonas.westerlund@senab.com

# MUUTO BILAGA INREDNINGSAARMATUR

APRIL

2023



Explore our new perspectives on Scandinavian design across furniture, lighting and accessories. Each design within our collection has its own family page with designer quote, product description, material information, cleaning instructions and more, followed by the pricing options for each individual variant.

INTRODUCTION TO THE PRICE LIST	1	Leaf Lamp Series	29	COLOR CODE INDEX	48
INDEX	2	Leaf Table Lamp	30	UPHOLSTERY OVERVIEW	49
		Leaf Floor Lamp	31	GENERAL TERMS OF SALE AND	
		Linear Lamp Series	32	DELIVERY	55
<b>FURNITURE</b>		Piton Portable Lamp	34		
Linear System Series	4	Post Lamp Series	36		
		Post Wall Lamp	37		
		Post Floor Lamp	38		
<b>LIGHTING</b>		Rime Lamp Series	39		
Ambit Lamp Series	15	Tip Lamp Series	42		
Beam Table Lamp	18	Tip Table Lamp	43		
Control Table Lamp	21	Tip Floor Lamp	44		
Cosy in Grey Table Lamp	23	Tip Wall Lamp	45		
Ease Portable Lamp	25	<b>MATERIAL OVERVIEW</b>	<b>46</b>		
Focus Table Lamp	27				

24% rabatt ska dras av på angivna priser

3

# FURNITURE

## LINEAR SYSTEM

“The Linear System Series places people at its center, being a place to meet, to collaborate or to work in focused solitude. The design process was about creating a system that made for intimately welcoming atmospheres, enhanced by the expression and functionality of its lighting and accessories. The Linear System Series brings feelings of home into larger spaces to give the user a sense of belonging. The extensive selection of lighting and accessories means that the Linear System Series can be configured and reshuffled for any purpose, marrying the ideas of aesthetics and function into one.”

— Thomas Bentzen



Designed by	Thomas Bentzen / 2020
Environment	Indoor
Country of Production	Table in Latvia / Power Outlet in England / Power Kit & Cable Tray in Germany
Assembly Required	Yes
Description	<p>The Linear System Series brings a new perspective to the evolving needs of modern spaces. The Linear System Table is a simple yet refined table with subtle details and references to the Scandinavian design heritage. Its legs are cut into half-circles and joined with the table for a light expression while the slender overhang at both ends of the table makes for a refined expression. The Linear System Table is available as a freestanding table to be used on its own, as predesigned configurations or as Middle and End Modules that can be configured to the exact needs of your space. Screens and trays are available in various sizes and are mounted into the ridge that runs down the tabletop, allowing for them to be shuffled around as functional and aesthetic needs evolve. Adjustable feet are included for the possibility of adjusting the height of the table's legs. Visit our Product Planner to explore the possible configurations: <a href="http://planner.muuto.com/linear">planner.muuto.com/linear</a></p>
Material	<p>Table: Tabletop comes in Oak veneer, black version in Ash veneer, Black Nanolaminate or White Laminate. Black Nanolaminate and White Laminate has an ABS edge. Table frame in veneered plywood and legs in Solid Oak. Felt glides included.</p> <p>Oak Veneer color variations: The Oak Veneer tabletops of the Linear System Series are made using high-quality mix-matched veneer to avoid differences in the visual appearance from tabletop to tabletop. However, wood is a natural material, and this means that slight variations can occur from table to table.</p> <p>Accessories: Screens are in solid oak and veneered MDF with powder coated aluminum fixing knobs. Possibility of upholstery on Screens. Tray 170 cm is in solid oak and veneered MDF, Tray Ø24 and Tray Ø36 are solid oak, all with powder coated aluminum fixing knobs. Cable Tray in PET felt.</p>
Cleaning & Care	<p>Wood &amp; Veneer Surfaces: Clean the table with a damp cloth. If necessary, only use a mild detergent or washing up liquid and not concentrated. Always wipe with a dry cloth afterwards. To minimize the risk of stains and marks, liquid, grease etc. should be removed straight away.</p> <p>Laminate Surface: Clean the table with a damp cloth. If necessary, use a mild detergent or washing up liquid and not concentrated. Always wipe with a dry cloth afterwards. To minimize the risk of stains and marks, liquids, grease etc. should be removed straight away.</p> <p>Warning for Power System: Disconnect from main supply before cleaning. Clean with soft dry cloth only. Always switch off electricity supply before cleaning.</p>

## LINEAR SYSTEM

### TESTS & CERTIFICATIONS

EN 15372:2016 - L3

Linear System Table:

Severe use. Furniture – Strength, durability and safety.  
Requirements for non-domestic tables.

VOC CDPH 01350 &  
VOC Bifma X7.1\*

Linear System Table incl. screens, trays, lamps and power outlet is VOC CDPH 01350 and VOC Bifma X7.1 tested.

\*Please note that the black versions of the Linear System Table and Linear System Accessories is only compliant for private office use.

The Linear System Series brings a new perspective to the evolving needs of the modern workspaces, hospitality settings and educational institutions through its configurable design across tables, lighting, screens and trays alongside its custom integrated power solution, allowing one to tailor the design to the exact needs of any space.

**Option A** — Choose between one of our predesigned table configurations and simply add your desired lamps and accessories.

**Option B** — Create your own configuration from scratch and add lamps and accessories from there. [Scroll down 6 pages.](#)

## Option A — Predesigned Table Configurations

### STEP 1. TABLES

Select either the Linear System Table or one of three Linear System Table Configurations.

#### Linear System Table

Height — 74 cm / 29.1"  
Table top width — 142 cm / 55.9"  
Total width — 146,9 cm / 57,8"  
Total length — 240 cm / 94.5"  
No of Persons — 4-6

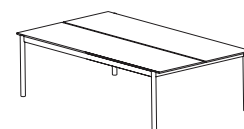

240 cm / 94.5"

#### Linear System Table Configuration 1

Height — 74 cm / 29.1"  
Table top width — 142 cm / 55.9"  
Total width — 146,9 cm / 57,8"  
Total length — 360 cm / 141.7"  
No of Persons — 6-8

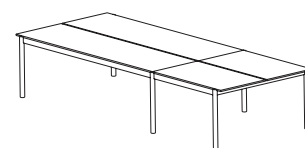

240 cm / 94.5"    120 cm / 47.2"

#### Linear System Table Configuration 2

Height — 74 cm / 29.1"  
Table top width — 142 cm / 55.9"  
Total width — 146,9 cm / 57,8"  
Total length — 480 cm / 189"  
No of Persons — 8-12

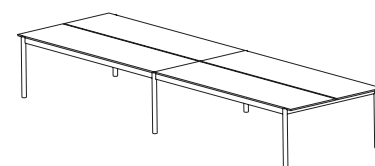

240 cm / 94.5"    240 cm / 94.5"

#### Linear System Table Configuration 3

Height — 74 cm / 29.1"  
Table top width — 142 cm / 55.9"  
Total width — 146,9 cm / 57,8"  
Total length — 720 cm / 283.5"  
No of Persons — 12-18

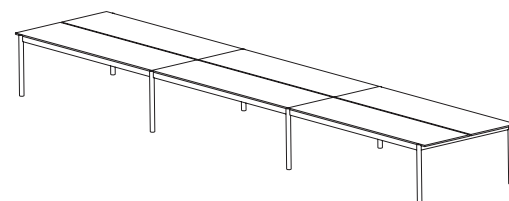

240 cm / 94.5"    240 cm / 94.5"    240 cm / 94.5"

### OPTION A

[1. TABLES](#) / [2. ACCESSORIES](#) / [3. LIGHTING](#) / [4. TABLE POWER OUTLET](#) / [5. INTEGRATED POWER](#) / [6. CABLE TRAY](#)



### STEP 2. ACCESSORIES

#### Trays

Add your desired number of Linear System Trays.

**Note**  
Trays must be mounted at least 5 cm / 2" from the table edge.

#### Linear System Tray — Ø24 cm / 9.5"

Height — 15,6 cm / 6.2"  
Diameter — 24 cm / 9.5"



#### Linear System Tray — Ø36 cm / 14.2"

Height — 9,6 cm / 3.8"  
Diameter — 36 cm / 14.2"



#### Linear System Tray — 170 cm / 66.9"

Height — 15 cm / 5.9"  
Width — 21 cm / 8.3"  
Length — 170 cm / 66.9"

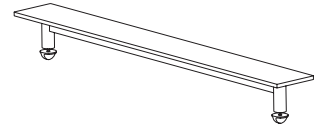

#### Screens

Add your desired number of Linear System Screens.

**Note**  
We recommend that screens are mounted to the table. They must be placed at least 5 cm / 2" from the table edge.

#### Linear System Screen — 75 cm / 29.5"

Height — 35 cm / 13.8"  
Width — 15 cm / 5.9"  
Length — 75 cm / 29.5"

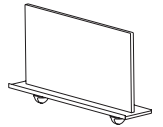

#### Linear System Screen — 125 cm / 49.2"

Height — 35 cm / 13.8"  
Width — 15 cm / 5.9"  
Length — 125 cm / 49.2"

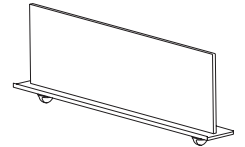

#### Linear System Screen — 178 cm / 70.1"

Height — 35 cm / 13.8"  
Width — 15 cm / 5.9"  
Length — 178 cm / 70.1"

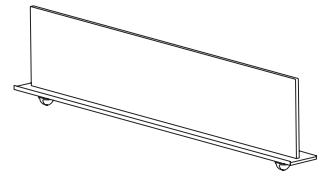

**Note**  
Please note that only the Linear System Screen 125 cm / 49.2" can be mounted across the table.

#### Example

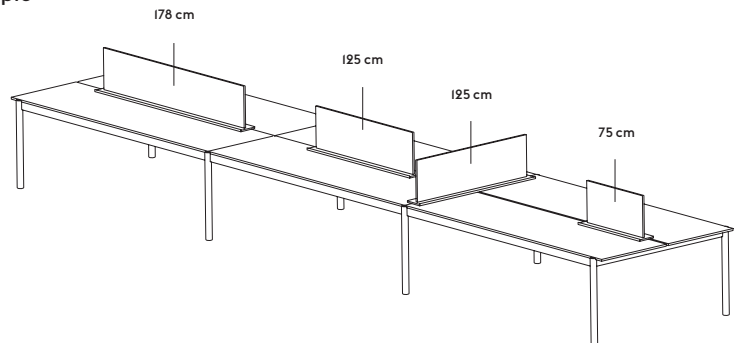

#### OPTION A

1. TABLES / 2. ACCESSORIES / 3. LIGHTING / 4. TABLE POWER OUTLET / 5. INTEGRATED POWER / 6. CABLE TRAY

### STEP 3. LIGHTING

Add your desired number of Linear Lamps.

#### Note

The Linear Table Lamp has one USB-C plug.

#### Linear Table Lamp

Height — 36,5 cm / 14.4"  
Width — 23,2 cm / 9.1"  
Depth — 16,5 cm / 6.5"



#### Note

Linear Mounted Lamp must be mounted at least 5 cm / 2" from the table edge.

Please be aware that the Linear Mounted Lamp and Table Power Outlet, both designed for the Linear System Series, have a special power solution with special plugs. See more on page 4

#### Linear Mounted Lamp — 23,2 cm / 9.1"

Height — 36,5 cm / 14.4"  
Width — 23,2 cm / 9.1"  
Depth — 10,7 cm / 4.2"



#### Linear Mounted Lamp — 209,2 cm / 82.4"

Height — 70,7 cm / 27.8"  
Width — 209,2 cm / 82.4"  
Depth — 10,7 cm / 4.2"



#### Linear Pendant Lamp — 87,2 cm / 34.3"

Height — 5,4 cm / 2.1"  
Width — 87,2 cm / 34.3"  
Depth — 10,7 cm / 4.2"



#### Linear Pendant Lamp — 169,2 cm / 66.6"

Height — 5,4 cm / 2.1"  
Width — 169,2 cm / 66.6"  
Depth — 10,7 cm / 4.2"



### STEP 4. TABLE POWER OUTLETS

Specify your desired number of Table Power Outlets. Each Table Power Outlet has two outlets (one at each end) and one USB-A and USB-C plug to which standard plugs can be connected. Kindly remember to select your region-specific version.

#### Note

Linear System Table Power Outlet must be mounted at least 5 cm / 2" from the table edge.

#### Linear System Table Power Outlet — EU, UK

Height — 7 cm / 2.8"  
Width — 7 cm / 2.8"  
Length — 18 cm / 7.1"

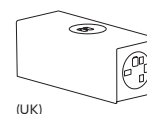
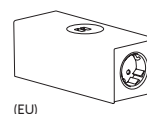

#### OPTION A

1. TABLES / 2. ACCESSORIES / 3. LIGHTING / 4. TABLE POWER OUTLET / 5. INTEGRATED POWER / 6. CABLE TRAY

### STEP 5. INTEGRATED POWER FOR MOUNTED LAMPS & TABLE POWER OUTLETS

If you'd like to add the Mounted Lamp(s) or Table Power Outlet(s), select the Table Power Kit for the Linear System Table or one of the three Power Configurations that match your selected Linear System Table Configuration. Kindly remember to select the region-specific power kit.

**Note**  
Each Distribution Block has five outlets to which up to five Linear Mounted Lamps or Linear System Table Power Outlets can be plugged in.

The Extension Kit must be connected to the Power Kit. An Extension Kit has no standard plug.

Distribution Block — 5-way

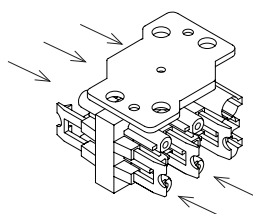

EU cable  
1,5 M cable

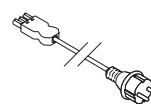

UK cable  
1,5 M fused plug

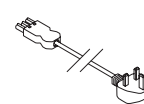

### Linear System Table

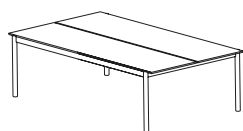

### Linear System Power

Power Kit (1 pcs)  
150 cm / 59" cable (EU or UK)  
Distribution Block

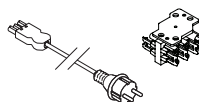

### Linear System Table Configuration 1

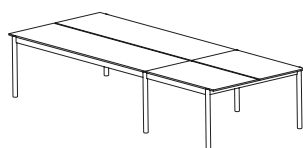

### Linear System Power Configuration 1

Power Kit (1 pcs)  
150 cm / 59" cable (EU or UK)  
Distribution Block

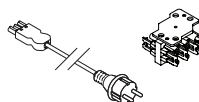

Power Extension Kit — 200 cm (1 pcs)  
200 cm / 79" cable  
Distribution Block

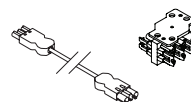

+

### Linear System Table Configuration 2

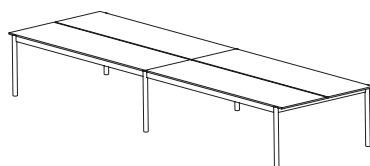

### Linear System Power Configuration 2

Power Kit (1 pcs)  
150 cm / 59" cable (EU or UK)  
Distribution Block

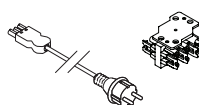

Power Extension Kit — 250 cm (1 pcs)  
250 cm / 98" cable  
Distribution Block

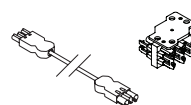

+

### Linear System Table Configuration 3

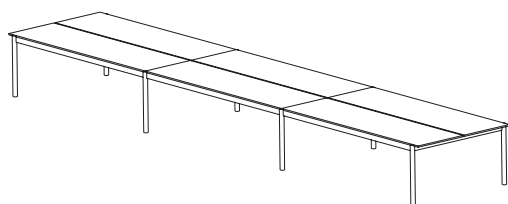

### Linear System Power Configuration 3

Power Kit (1 pcs)  
150 cm / 59" cable (EU or UK)  
Distribution Block

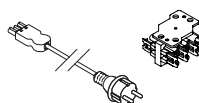

Power Extension Kit — 250 cm (2 pcs)  
250 cm / 98" cable  
Distribution Block

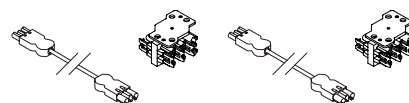

+

### OPTION A

1. TABLES / 2. ACCESSORIES / 3. LIGHTING / 4. TABLE POWER OUTLET / 5. INTEGRATED POWER / 6. CABLE TRAY

**Note**  
The Integrated Power for Linear System Series has unique internal plugs to provide a slim and discreet look. This means that you cannot connect a standard plug to the power without using the Linear Table Power Outlet or changing the standard plug to a matching plug, being the Wieland GSTI813 plug.

The Linear Mounted Lamps must be connected to the integrated Power Kit.

Wieland GSTI813 plug

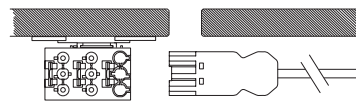

Standard plug (EU or UK)

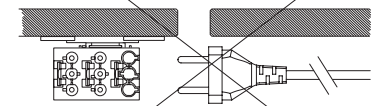

1. Connecting using the Wieland GSTI813 plug

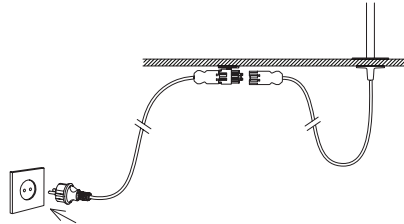

2. Connecting using a standard plug to the Linear Table Power Outlet

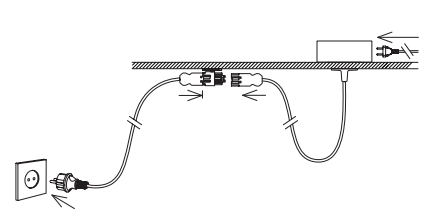

## LINEAR TABLE LAMP ONLY

The Linear Table Lamp can either be connected to a standard wall plug or the Table Power Outlet.

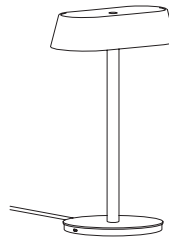

Standard plug

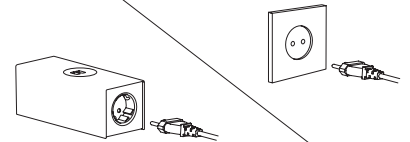

Linear Table Power Outlet

Alternatively, you can connect it to the integrated Power Kit by replacing the plug with a custom Wieland GSTI813 plug that is included with the lamp. Kindly refer to the Linear Table Lamp manual for instructions.

Integrated Power Kit (Wieland GSTI813 plug)

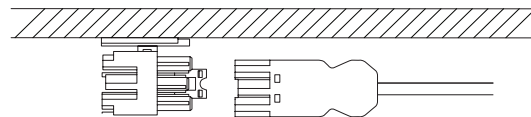

## OPTION A

1. TABLES / 2. ACCESSORIES / 3. LIGHTING / 4. TABLE POWER OUTLET / 5. INTEGRATED POWER / 6. CABLE TRAY

### STEP 6. CABLE TRAYS

We recommend using 1 Cable Tray for the End Module – 120 cm / 47.2" and up to 3 Cable Trays for the Linear Table, End Module – 240 cm / 94.2" and the Middle Module – 240 cm / 94.2".

### Linear System Cable Tray

Height – 3 cm / 1.2"  
Width – 22 cm / 8.7"  
Depth – 60 cm / 23.7"

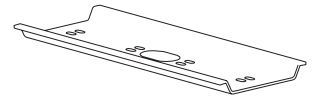

### Example:

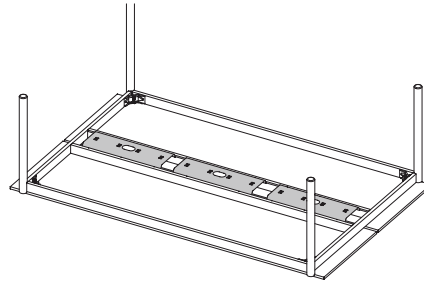

Linear System Table – 240 cm / 94.5"

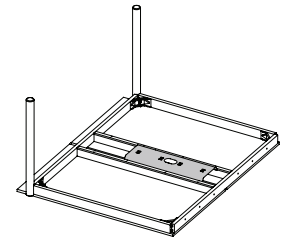

Linear System End Module – 120 cm / 47.2"

### OPTION A

1. TABLES / 2. ACCESSORIES / 3. LIGHTING / 4. TABLE POWER OUTLET / 5. INTEGRATED POWER / 6. CABLE TRAY

## Option B — Create your own configuration

### STEP 1. TABLES

#### A)

A configuration must always have End Modules in each end.

Start by defining the total length of your desired configuration, then select two table ends.

#### Linear System End Module — 240 cm / 94.5"

Height — 74 cm / 29.1"  
 Width — 146,9 cm / 57.8"  
 Length — 240 cm / 94.5"  
 No of Persons — 4-6



#### Linear System End Module — 120 cm / 47.2"

Height — 74 cm / 29.1"  
 Width — 146,9 cm / 57.8"  
 Length — 120 cm / 47.2"  
 No of Persons — 2



#### B)

Next, add the second, and final, End Module or your desired number of Middle Modules, only available in 240 cm / 94.5".

**Note**  
 Please note that it is not possible to connect more than two End Modules.

#### Linear System Middle Module — 240 cm / 94.5"

Width — 146,9 cm / 57.8"  
 Length — 240 cm / 94.5"  
 No of Persons — 4-6



#### C)

Next, you must order 1 set of Connecting Legs every time two modules are connected.

#### Linear System Connecting Legs

Height — 74 cm / 29.1"

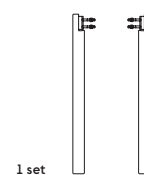

If you'd like a configuration of one End Module — 240 cm / 94.5" and one Middle Module — 240 cm / 94.5" and one End Module — 240 cm / 94.5", you must order two sets of Connecting Legs, as shown in the illustration.

#### Example

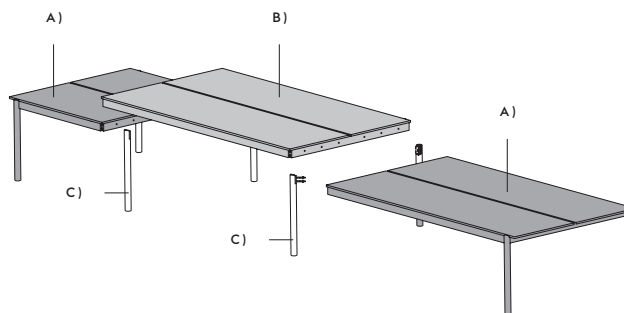

OPTION B  
 1. TABLES / 2. ACCESSORIES / 3. LIGHTING / 4. TABLE POWER OUTLET / 5. INTEGRATED POWER / 6. CABLE TRAY

24% rabatt ska dras av på angivna priser

LINEAR TABLE LAMP



Shipper Colli 1  
Gross Weight (kg) 1.832  
Net Weight (kg) 1.3  
Warranty Period 5 years

Item No.	Color	Contract Price	Lead Time
<b>Ready-To-Ship</b>			
22510	Black	SEK 3.826,10	-
22511	Grey	SEK 3.826,10	-

24% rabatt ska dras av på angivna priser

14

# LIGHTING



## AMBIT LAMP SERIES

"What defines our attraction to shapes? With the Ambit Lamp Series, we wanted to explore form and proportions in a thorough and meticulous way. We discovered a unique dynamic between linear and rounded shapes that gives the lamp its unique outline, making the Ambit Lamp Series a timeless design that you'll never grow tired of while its handspun aluminum material and contrasting white inner makes for an elegant touch."

— TAF Studio



Designed by	TAF Studio / 2015, 2017, 2019 & 2021
Environment	Indoor
Country of Production	China
Cord Length	Pendant Lamp and Rail Lamp: 400 cm / 157.5" Wall Lamp: 250 cm / 98.4"
Bulb Included	Pendant Lamp Ø16,5 and Wall Lamp: Yes Pendant Lamp Ø55, Ø40, Ø25 and Rail Lamp: No
Ceiling Cap Included	Pendant Lamp and Rail Lamp: Yes Wall Lamp: No
Dimmable Function	Rail lamp: Yes (can be dimmed with industry standard phasecut dimmers, if dimmable bulb is used)  Ambit Ø16,5: Yes (can be dimmed with industry standard phasecut dimmers)  Ambit Ø25, Ø40 and Ø55: Yes (can be dimmed with industry standard phasecut dimmers, if dimmable bulb is used)
Socket Size	Ambit Ø25 and Rail Lamp: E14 Ambit Ø40 and Ø55: E27 Ambit Ø16,5 and Wall Lamp: GX53
Description	Embodying the values of Scandinavian design, the Ambit Lamp Series is as timeless as it is contemporary. Made of hand-spun aluminum that has been hand-painted, the Ambit Lamp Series features clean lines and a white interior that heighten contrasts of its outside shade while enhancing the light emitted in any room of a home, office or commercial space. Use the design on its own or symmetric formations and vibrant clusters.
Material	Aluminum lamp shades. Made from old brazer traditions, the lamp shades are press spun by hand. Hereafter, the lamp shades are polished and painted by hand. PVC cord.

## AMBIT LAMP SERIES

### Cleaning & Care

#### Rail Lamp:

The rail for the Ambit Rail Lamp is cut from tubes that are adjusted to fit each other on a lathe machine. Rail made from cast and extruded aluminum.

#### Wall Lamp:

Arm fixture and wall mount piece for the Ambit Wall Lamp are made from aluminum. An extra wall bracket is included in the Ambit Wall Lamp that allows for the wiring to be integrated into the wall.

Clean the lamp with a soft dry cloth. Always switch off the electricity before cleaning.

### TESTS & CERTIFICATIONS

#### EU:

IEC 60598-1 and IEC 60598-2-1

Low Voltage Directive (LVD) - 2014/35/EU

ECO Design Directive - 245/2009/EC

ROHS Directive - 2011/65/EU amended RoHS 3 Directive 2015/863

REACH Directive - EC/1907/2006

WEEE Directive - 2012/19/EU

#### UK:

BS EN 60598-1 and BS 4533-102.1, EN 60598-2-1

Electrical Equipment (Safety) Regulations 2016

Electromagnetic Compatibility Regulations 2016

The Restriction of the Use of Certain Hazardous Substances in Electrical and Electronic Equipment Regulations 2012

The Ecodesign for Energy-Related Products and Energy Information (Amendment) (EU Exit) Regulations 2019

#### USA/Canada:

UL STD. 1598 / CSA STD. C22.2 NO.250.0

#### Australia/New Zealand:

AS/NZS 60598.1 and AS/NZS 60598.2.1

\*Does not apply to Ambit Pendant Ø16.5 and Ambit Wall Lamp

#### China:

\*GB 7000.201 and GB 7000.1

\*Please note that this certification does not apply for the Ambit Wall Lamp

# 24% rabatt ska dras av på angivna priser

## AMBIT WALL LAMP

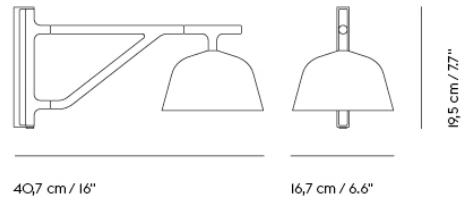

Shipper Colli	1
Gross Weight (kg)	1.734
Net Weight (kg)	1.04
Warranty Period	5 years

Item No.	Color	Contract Price	Lead Time
<b>Ready-To-Ship</b>			
15311	Black	SEK 3.138,10	-
15313	Grey	SEK 3.138,10	-
15314	Taupe	SEK 3.138,10	-
15312	White	SEK 3.138,10	-
<b>Extras</b>			
15804	Ambit / Fluid / Rime Ø12+Ø18+25 Cord - White (per linear meter)	SEK 59,30	-
15801	Ambit / Grain / Rime Ø12+Ø18+25 Cord - Black (per linear meter)	SEK 59,30	-
15803	Ambit Cord - Grey (per linear meter)	SEK 59,30	-
15806	Ambit Cord - Taupe (per linear meter)	SEK 59,30	-

## BEAM TABLE LAMP

"The idea for the Beam Table Lamp came while renovating my childhood home. I had made a shelf to use as divider between the hallway and living room and needed a lamp that could at once throw light out into the living room and down the hallway. The Beam Table Lamp mimics a single ray of light that travels through a round tube with its dimmer allowing the user to change the volume of light omitted from both ends of the cylinder shape. Tweak the design to your personal needs through its rotating base and sleek body of anodized aluminum, whether it be as direct lighting or for an ambient glow. With the Beam Table Lamp, you can alter the volume of light omitted, change its direction by the turn of its base and place it on any shelf, table or windowsill for a new perspective on modern lighting."

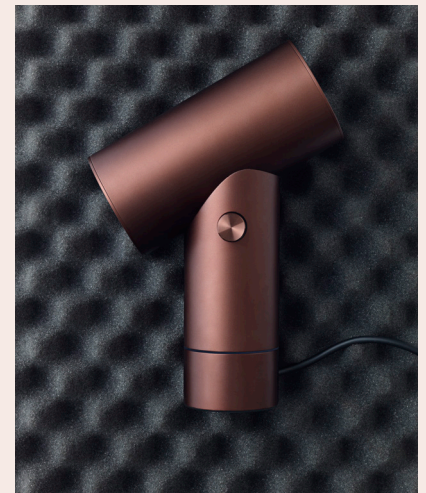

— Tom Chung

Designed by	Tom Chung / 2018
Environment	Indoor
Country of Production	China
Cord Length	250 cm / 98.4"
Bulb Included	Yes
Dimmable Function	Yes
Description	The Beam Table Lamp is a versatile table lamp with a modern expression and intuitive user-friendliness. With light shone from both ends of a cylinder shape, the user can choose between three different volumes of light and gradually alter the volume of light emitted in each end through the turn of a playful dial. The Beam Table Lamp can be altered for any position with its rotating base and sleek body of anodized aluminum, whether it be as direct lighting or for an ambient glow in any home, offices, hotel room and educational areas.
Material	Body in anodized aluminum for a matte feel and vibrant look. Cord in PVC. It has a built-in energy efficient LED bulb. The lifetime of the LED bulb is defined as the time it takes until the light output/lumen maintenance reaches 90% (L90) of the initial output. The integrated bulb has a lifespan/lumen maintenance (L90) of 35,000 hours.
Cleaning & Care	Clean with soft dry cloth only. Always switch off electricity supply before cleaning.

## BEAM TABLE LAMP

### TESTS & CERTIFICATIONS

#### EU:

IEC 60598-1 and IEC 60598-2-4

Low Voltage Directive (LVD) - 2014/35/EU

ECO Design Directive - 245/2009/EC

ROHS Directive - 2011/65/EU amended RoHS 3 Directive  
2015/863

REACH Directive - EC/1907/2006

WEEE Directive - 2012/19/EU

#### UK:

BS EN 60598-1 and EN 60598-2-4

Electrical Equipment (Safety) Regulations 2016

Electromagnetic Compatibility Regulations 2016

The Restriction of the Use of Certain Hazardous Substances in

Electrical and Electronic Equipment Regulations 2012

The Ecodesign for Energy-Related Products and Energy

Information (Amendment) (EU Exit) Regulations 2019

#### The Eurasian Economic Union:

TP TC 004 and TP TC 020

#### USA/Canada:

UL STD. 153 / CSA STD. C22.2 NO.250.4

24% rabatt ska dras av på angivna priser

BEAM TABLE LAMP

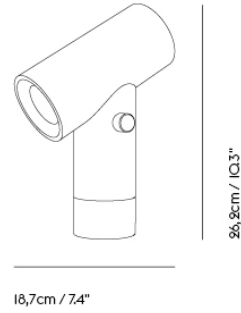

Shipper Colli 1  
Gross Weight (kg) 1.72  
Net Weight (kg) 1.234  
Warranty Period 5 years

Item No.	Color	Contract Price	Lead Time
<b>Ready-To-Ship</b>			
12124	Aluminum	SEK 2.536,10	-
12121	Black	SEK 2.536,10	-
12123	Green	SEK 2.536,10	-
12122	Umber	SEK 2.536,10	-

## CONTROL TABLE LAMP

"The Control Table Lamp is a unique and playful lamp with references to hi-fi and industrial machinery. The light and dimmer is controlled by a switch, referencing volume controls, and is an inviting and simple way of interacting with the user. While designing the lamp, we were inspired by the idea of displaying the different lamp components on a serving plate—almost as a still life. It was a pragmatic approach to making a lamp by the simplest means, a reduced design beyond reduction."

— TAF Studio



Designed by	TAF Studio / 2016
Environment	Indoor
Country of Production	China
Cord Length	250 cm / 98.5"
Bulb Included	Yes
Dimmable Function	Yes
Socket Size	E27
Description	The Control Table Lamp places the iconic E27 bulb in a modern context. With the user being able to alter the volume of light emitted according to their preferences through the playful turn of a dial, the Control Table Lamp combines industrial design with Scandinavian values.
Material	The lamp's base is casted in aluminum, polished and finally powder coated. Cord in PVC.
Cleaning & Care	Clean with soft dry cloth only. Always switch off the electricity supply before cleaning.

### TESTS & CERTIFICATIONS

EU:

EN 60598-1 and EN 60598-2-4

Low Voltage Directive (LVD) - 2014/35/EU

ECO Design Directive - 245/2009/EC

ROHS Directive - 2011/65/EU amended RoHS 3 Directive 2015/863

REACH Directive - EC/1907/2006

WEEE Directive - 2012/19/EU

UK:

BS EN 60598-1 and EN 60598-2-4

Electrical Equipment (Safety) Regulations 2016

Electromagnetic Compatibility Regulations 2016

The Restriction of the Use of Certain Hazardous Substances in Electrical and Electronic Equipment Regulations 2012

The Ecodesign for Energy-Related Products and Energy Information (Amendment) (EU Exit) Regulations 2019

USA/Canada:

UL STD. 153 / CSA STD. C22.2 NO.250.4

Australia/New Zealand:

AS/NZS 60598.1 and AS/NZS 60598.2.4

# 24% rabatt ska dras av på angivna priser

## CONTROL TABLE LAMP

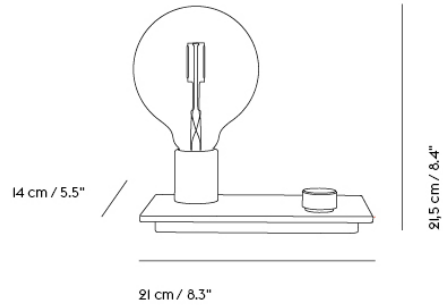

Shipper Colli 1  
Gross Weight (kg) 1.4055  
Net Weight (kg) 0.9125  
Warranty Period 5 years

Item No.	Color	Contract Price	Lead Time
<b>Ready-To-Ship</b>			
15410	Black	SEK 1.504,10	-
15412	Grey	SEK 1.504,10	-
15413	Red	SEK 1.504,10	-
15411	White	SEK 1.504,10	-



## COSY IN GREY TABLE LAMP

"The idea for the Cosy In Grey was to create a lamp that created a spatial atmosphere within the room. I put my trust in the natural material of glass; its beauty and changing reflections. The Cosy In Grey Table Lamp expresses the beauty of electrical light in a modern form. Whether it be early mornings, during lunch or a cold night, the Cosy In Grey Table Lamp will bring a warm and friendly atmosphere to any space."

— Harri Koskinen



Designed by	Harri Koskinen / 2006
Environment	Indoor
Country of Production	China
Cord Length	260 cm / 102.25"
Bulb Included	No. Only use dimmable bulb.
Dimmable Function	Yes
Socket Size	E27
Description	With its modern shape in mouth-blown glass, the Cosy In Grey Table Lamp provides gentle lighting through its dimmable naked bulb, encased in smoked grey glass. Place the Cosy In Grey Table Lamp in any space for a new perspective on ambient lighting.
Material	The Cosy in Grey Table Lamp is handmade, mouth blown in colored soda lime glass, cut grinded and polished by hand. PVC cord with a dimmer, plastic socket and an internal clear plastic construction to secure cord and socket. Bulb not included.
Cleaning & Care	Clean with soft dry cloth only. Always switch off the electricity supply before cleaning.

### TESTS & CERTIFICATIONS

#### EU:

EN 60598-1 and EN 60598-2-4

Low Voltage Directive (LVD) - 2014/35/EU

ECO Design Directive - 245/2009/EC

ROHS Directive - 2011/65/EU amended RoHS 3 Directive 2015/863

REACH Directive - EC/1907/2006

WEEE Directive - 2012/19/EU

#### UK:

BS EN 60598-1 and EN 60598-2-4

Electrical Equipment (Safety) Regulations 2016

Electromagnetic Compatibility Regulations 2016

The Restriction of the Use of Certain Hazardous Substances in Electrical and Electronic Equipment Regulations 2012

The Ecodesign for Energy-Related Products and Energy Information (Amendment) (EU Exit) Regulations 2019

# 24% rabatt ska dras av på angivna priser

## COSY IN GREY TABLE LAMP

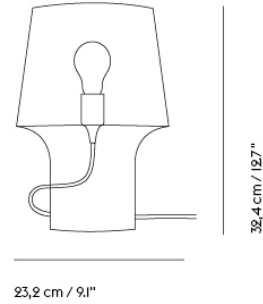

Shipper Colli 1  
Gross Weight (kg) 4.75  
Net Weight (kg) 3.49  
Warranty Period 5 years

Item No.	Color	Contract Price	Lead Time
<b>Ready-To-Ship</b>			
01033	Grey	SEK 2.317,70	-
<b>Extras</b>			
01040	LED Bulb	SEK 231,30	-

## EASE PORTABLE LAMP

"I wanted the Ease Portable Lamp to have a remarkable quality of light, striking a versatile balance between atmospheric and functional light — after all, that is the wonderful thing about a portable lamp — you can bring a distinct ambience to literally anywhere. I landed on the idea of the top and bottom gently touching, softly meeting each other. There is a sense of lightness to it. This feature allows a large surface to emit light, while the flared bottom firmly stabilizes it. It is these details that give the lamp a sort of human quality, making it a reliable friend."

— Johan van Hengel



Design by	Johan van Hengel / 2023
Environment	Indoor / Outdoor
Country of Production	China
Cord Length	90 cm / 35.4"
Bulb Included	Yes - Integrated, non replaceable LED
Dimmable Function	Yes - Three step dimming
Description	Inspired by shapes of traditional table lamps, the Ease Portable Lamp transforms this typology into a carryable size, suitable to take wherever. Ease offers a high-quality dimmable, no-glare light with three levels, striking a balance between atmospheric and functional light. The design has a distinct lightness to it, with the top and bottom gently touching. A slightly flared bottom mimics the lip of a vase in a grounding gesture that allows the base to be slimmer and easier to grab. Ease Portable Lamp is a humble friend with a strong character that works alone or in repetition in any setting; from the bedside, reading nook and home office to the restaurant or café table, co-working space or library.
Material	Battery-powered, dimmable and portable lamp with 8 hours of battery life on 100% intensity, 16 hours on 50% intensity and 29 hours on 25% intensity. Body and lampshade made in injection-molded ABS plastic, with an integrated LED light source. Diffuser in opal acrylic. Charging dock made in injection-molded ABS plastic with USB-C cable. Lumen Maintenance (L70): 52.000h. Lumen: 230lm on 100% brightness. Kelvin: 2700K. CRI >90.  The Ease Portable lamp is suitable for outdoor use with an IP54 rating. The lamp is protected and tested against solid foreign objects, such as dust ingress, as well as liquids, such as water splashes, from all angles.
Cleaning & Care	Clean with a moist cloth. If necessary, use a little dish soap on the cloth.

### TESTS & CERTIFICATIONS

#### EU:

IEC 60598-1 and IEC 60598-2-1  
Low Voltage Directive (LVD) - 2014/35/EU  
ECO Design Directive - 245/2009/EC  
ROHS Directive - 2011/65/EU amended RoHS 3 Directive 2015/863  
REACH Directive - EC/1907/2006  
WEEE Directive - 2012/19/EU  
Electromagnetic Compatibility (EMC) Directive - 2014/30/EU

#### UK:

BS EN 60598-1 and BS 4533-102.1, EN 60598-2-1  
Electrical Equipment (Safety) Regulations 2016  
Electromagnetic Compatibility Regulations 2016  
The Restriction of the Use of Certain Hazardous Substances in Electrical and Electronic Equipment Regulations 2012  
The Ecodesign for Energy-Related Products and Energy Information (Amendment) (EU Exit) Regulations 2019

Australia/New Zealand:  
AS/NZS 60598.1 and AS/NZS 60598.2.4

## EASE PORTABLE LAMP



13,16 cm / 5.18"

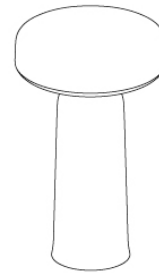

21,5 cm / 8.46"

Shipper Colli	1
Gross Weight (kg)	0.947
Net Weight (kg)	0.63
Warranty Period	5 years

Item No.	Color	Contract Price	Lead Time
<b>Ready-To-Ship</b>			
22740	Black	SEK 1.762,10	-
22741	Grey	SEK 1.762,10	-
22743	Light Blue	SEK 1.762,10	-
22742	Taupe	SEK 1.762,10	-

## FOCUS TABLE LAMP

"The Focus Table Lamp is an everyday object with a sculptural appeal and an apparent function: it is a lamp and a pedestal where your favorite small objects may be placed and highlighted. Working with the appearance and the delicate dimensions, I tried to give the lamp a unique personality characterized by an embracing and protective nature. The focus is on the pedestal and the object which is placed on it. Therefore, all components are fixed in position. Personally, the pedestal, with a cone of ambient light, solved my problem of misplacing my keys. Now I always know where they are."

— Andreas Bergsaker



Designed by	Andreas Bergsaker / 2017
Environment	Indoor
Country of Production	China
Bulb Included	Yes
Dimmable Function	No
Socket Size	GU10
Description	Scandinavian in its expression, the Focus Table Lamp highlights its ash wood body with black paint that allows for the texture of the wood to shine through. With a protruding base that is perfect for small items, the lamp fits seamlessly on a windowsill or shelf in need a bit of light.
Material	Focus Lamp's wooden components are shaped on a lathe machine. The electrical parts are hidden inside the lamps components, which are glued together to hide that they were ever apart. Thereafter, the lamp is painted. Ash wood and PVC cord.
Cleaning & Care	Clean with soft dry cloth only. Always switch off the electricity supply before cleaning.

### TESTS & CERTIFICATIONS

EU:

EN 60598-1 and EN 60598-2-4

Low Voltage Directive (LVD) - 2014/35/EU

ECO Design Directive - 245/2009/EC

ROHS Directive - 2011/65/EU amended RoHS 3 Directive 2015/863

REACH Directive - EC/1907/2006

WEEE Directive - 2012/19/EU

UK:

BS EN 60598-1 and EN 60598-2-4

Electrical Equipment (Safety) Regulations 2016

Electromagnetic Compatibility Regulations 2016

The Restriction of the Use of Certain Hazardous Substances in Electrical and Electronic Equipment Regulations 2012

The Ecodesign for Energy-Related Products and Energy Information (Amendment) (EU Exit) Regulations 2019

24% rabatt ska dras av på angivna priser

FOCUS TABLE LAMP

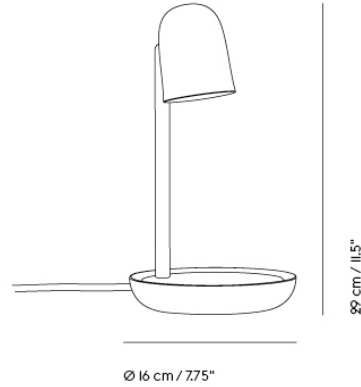

Shipper Colli 1  
Gross Weight (kg) 1.05  
Net Weight (kg) 0.695  
Warranty Period 5 years

Item No.	Color	Contract Price	Lead Time
<b>Ready-To-Ship</b>			
21952	Black	SEK 1.332,10	-

## LEAF LAMP SERIES

"Combining a light and elegant design with an energy-efficient LED technology, the Leaf Lamp Series has a clean and refined expression. The asymmetric geometry of the design gives it an organic and friendly appearance, inspired by the leaves on a tree. Turn the Leaf Lamp according to your needs and discover how the lamp will subtly transform its shape, adding a graphic and gentle light silhouette to any space."

— Broberg & Ridderstråle



Designed by	Broberg & Ridderstråle / 2012
Environment	Indoor
Country of Production	China
Cord Length	180 cm / 71"
Bulb Included	Yes
Dimmable Function	Yes
Description	With its elegantly simple lines, the Leaf Lamp Series brings ambient as well as direct lighting to any space, paired with its organic shape that is inspired by the leaves of a tree. The design features a dimmable LED light alongside a turnable head, allowing for its user to position the light as desired for one's individual space and atmosphere.
Material	Aluminum, brass, colored PVC cord.  Leaf is a result of a process combining turned and casted aluminum and steel, with a strong powder coating as paint. It has a build-in energy-efficient LED bulb with a Lumen Maintenance (Lifetime) of L90 BIO 35.000 hours.
Cleaning & Care	Wipe off dust with dry cloth. If necessary use moist cloth, then dry off. Do not use abrasive cleaning agents. Always switch off the electricity supply before cleaning.

### TESTS & CERTIFICATIONS

EU:

IEC 60598-1 and IEC 60598-2-4

Low Voltage Directive (LVD) - 2014/35/EU

ECO Design Directive - 245/2009/EC

ROHS Directive - 2011/65/EU amended RoHS 3 Directive 2015/863

REACH Directive - EC/1907/2006

WEEE Directive - 2012/19/EU

UK:

BS EN 60598-1 and EN 60598-2-4

Electrical Equipment (Safety) Regulations 2016

Electromagnetic Compatibility Regulations 2016

The Restriction of the Use of Certain Hazardous Substances in Electrical and Electronic Equipment Regulations 2012

The Ecodesign for Energy-Related Products and Energy Information (Amendment) (EU Exit) Regulations 2019

USA/Canada:

UL STD. I53 / CSA STD. C22.2 NO.250.4

Australia/New Zealand:

AS/NZS 60598.1 and AS/NZS 60598.2.4

24% rabatt ska dras av på angivna priser

LEAF TABLE LAMP

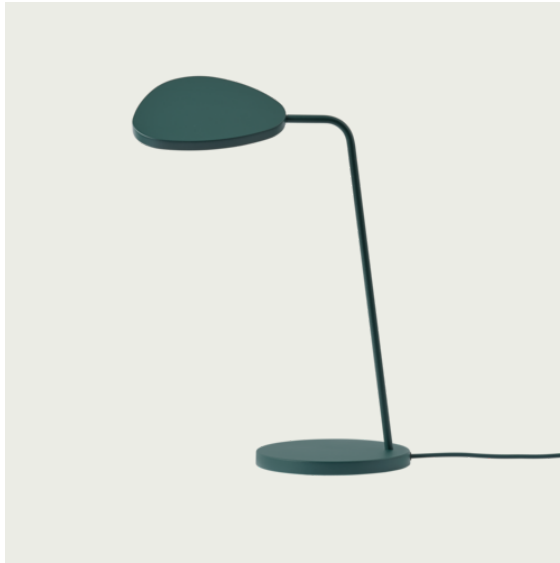

15,5 x 18,5 cm / 6" x 7.25"

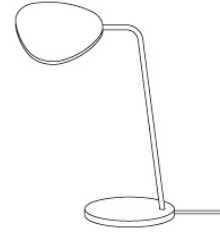

41,5 cm / 16.25"

18 cm / 7"

Shipper Colli	1
Gross Weight (kg)	2.44
Net Weight (kg)	1.8
Warranty Period	5 years

Item No.	Color	Contract Price	Lead Time
<b>Ready-To-Ship</b>			
13422	Black	SEK 2.536,10	-
13423	Copper Brown	SEK 2.536,10	-
13424	Dark Green	SEK 2.536,10	-
13420	Grey	SEK 2.536,10	-
13421	White	SEK 2.536,10	-



# 24% rabatt ska dras av på angivna priser

## LEAF FLOOR LAMP

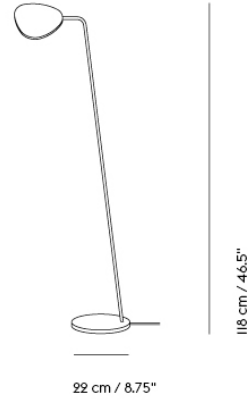
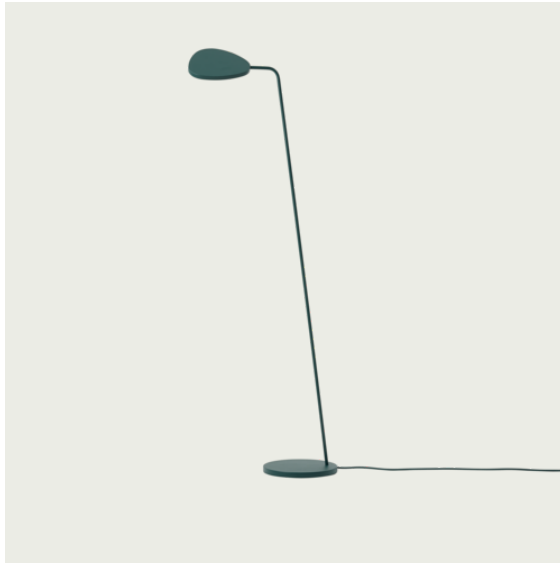

Shipper Colli 1  
Gross Weight (kg) 4.793  
Net Weight (kg) 2.8  
Warranty Period 5 years

Item No.	Color	Contract Price	Lead Time
<b>Ready-To-Ship</b>			
13432	Black	SEK 3.482,10	-
13433	Copper Brown	SEK 3.482,10	-
13434	Dark Green	SEK 3.482,10	-
13430	Grey	SEK 3.482,10	-
13431	White	SEK 3.482,10	-

## LINEAR LAMP SERIES

“The Linear Lamp Series is designed from the idea of creating smaller atmospheres through modern light, bringing a sense of intimacy to larger spaces. With their elegant expression, subtle details and inherent functionality, the designs create space for both being and working on your own as well as making for a friendly environment when in the company of others. Use the Linear Lamp Series in any space in need of modern, functional lighting.”

— Thomas Bentzen



Designed by	Thomas Bentzen / 2020
Environment	Indoor
Country of Production	China
Cord Length	Table Lamp: 250 cm / 98.4". Mounted Lamp: 150 cm / 59.1". Pendant Lamp: 400 cm / 157.5"
Bulb Included	Yes - integrated LED
Dimmable Function	Yes: Table Lamp and Mounted Lamp / No: Pendant Lamp
Description	Designed from the idea of creating smaller spaces within larger settings, the Linear Lamp Series by Thomas Bentzen is created with subtlety at its heart—simple lines, inviting functionalities and dimmable light that can be adjusted to any setting. The Linear Table & Mounted Lamps hint toward the archetypal library lamp with a modern expression, paired with the extensive functionality of dimmability. Available in two sizes, the Linear Mounted Lamp brings a friendly canopy of light to any space.
Material	Linear Pendant Lamp: Powder coated lamp head in pressure die-casted and extruded aluminum.  Linear Table Lamp & Linear Mounted Lamp: Powder coated lamp head in extruded aluminum. Diffuser in polycarbonate. PVC cord.
Cleaning & Care	Clean with a moist cloth. If necessary, use a little dish soap on the cloth.

24% rabatt ska dras av på angivna priser

LINEAR TABLE LAMP



Shipper Colli 1  
Gross Weight (kg) 1.832  
Net Weight (kg) 1.3  
Warranty Period 5 years

Item No.	Color	Contract Price	Lead Time
<b>Ready-To-Ship</b>			
22510	Black	SEK 3.826,10	-
22511	Grey	SEK 3.826,10	-

## PITON PORTABLE LAMP

"My idea for Piton started from the desire to create a rechargeable portable lamp that could be adapted in a multitude of ways while functioning in various environments. I wanted the design to fulfill the inherent needs of a torch; providing security and warmth while clearly illuminating your field of vision. Piton takes its name from a climbing apparatus that is jammed into cracks and crevices on mountainsides to which the climber can attach hooks, tools and ropes while rigging it in various positions; an element that is also present in the design of the Piton Portable Lamp."

— Tom Chung



Designed by	Tom Chung / 2022
Environment	Indoor / Outdoor
Country of Production	China
Cord Length	300 cm textile USB cable (no power adapter included)
Bulb Included	Yes - integrated LED
Dimmable Function	Yes - Continuous
Description	Piton is an untraditional take on the battery-powered portable lamp, playfully referencing the archetypal flashlight. Refined anodized extruded aluminum enhances its elegant form and distinct functionality inspired by tools used for mountain climbing. It is a versatile ambient light with 6 hours of battery life on 100% brightness and 13,5 hours on 50% brightness that can be used lying, standing, tilting on a shelf or suspended, depending on the space or spot you want to illuminate, effortlessly moving between indoors and outdoors.
Material	Battery-powered portable lamp with 6 hours of battery life on 100% brightness and 13,5 hours on 50% brightness. Continuous dim function. Body made from anodized extruded aluminum. Lamp shade made in injection molded plastic with an integrated and replaceable LED light bulb. Comes with a woven fabric USB-C cable for charging.  The Piton Portable Lamp is suitable for outdoor use with an IP54 rating. The lamp is protected and tested against solid foreign objects, such as dust ingress, as well as liquids, such as water splashes, from all angles.
Cleaning & Care	Clean with a moist cloth. If necessary, use a little dish soap on the cloth. Always switch off the electricity supply before cleaning.

### TESTS & CERTIFICATIONS

EU:

ECO Design Directive - 245/2009/EC

ROHS Directive - 2011/65/EU amended RoHS 3 Directive 2015/863

REACH Directive - EC/1907/2006

WEEE Directive - 2012/19/EU

Electromagnetic compatibility - EN IEC 55015 / EN IEC 61000 / EN 61547

UK:

The Restriction of the Use of Certain Hazardous Substances in Electrical and Electronic Equipment Regulations 2012

The Ecodesign for Energy-Related Products and Energy Information (Amendment) (EU Exit) Regulations 2019

Electromagnetic compatibility - BS EN 6100 / BS EN IEC 55015 / BS EN 61547

Australia/New Zealand:

AS/NZS 60598.1 / 60598.2.4

AS/NZS 61347.1 / 61347.2.13

IEC 62031

IEC TR62778

# 24% rabatt ska dras av på angivna priser

## PITON PORTABLE LAMP



13,2 cm / 5.2"

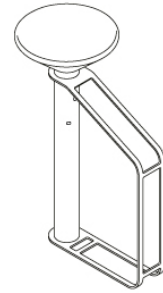

32,1 cm / 12.6"

21,8 cm / 8.6"

Shipper Colli 1  
Net Weight (kg) 0.539  
Warranty period 5 years

Item No.	Color	Contract Price	Lead Time
<b>Ready-To-Ship</b>			
22581	Aluminum	SEK 1.973,70	-
22580	Black	SEK 1.973,70	-

## POST LAMP SERIES

"The Post Lamp Series came from the idea of exploring the flexibility of the magnetic joint, giving the user the freedom to position and dim the lamp's light units according to individual needs. Designed with a sculptural expression, simple lines and a refined finish, the Post Lamp Series represents a new perspective through its graphic character and forward-thinking functionality."

— Earnest Studio



Designed by	Earnest Studio / 2020
Environment	Indoor
Country of Production	China
Cord Length	Lighting units: 250 cm / 98.4" / Power Hub: 200 cm / 78.7"
Bulb Included	Yes
Dimmable Function	Yes

The Post Lamp Series is an innovative lighting design with an archetypal appearance, graphic character and forward-thinking functionalities. Exploring the utmost flexibility of a magnetic joint, the user can position, dim and turn the lamp according to individual needs. Arrange the cord of the design in linear or playful formations on the wall, using its cable drop. Additional lighting units can be purchased as spare part and plugged into power hub.

Description	Lighting unit in powder coated magnesium with silicone cord and acrylic opal diffuser. Power hub in powder coated plastic with PVC cord.
Material	Post Wall Lamp: Wall mounting bracket in powder coated steel. Wall cable drops in powder coated steel with magnet and repositionable adhesive tape.  Post Floor Lamp: Base in powder coated steel. Cable drops in powder coated plastic with magnet.
Cleaning & Care	Clean with soft dry cloth only. Always switch off the electricity supply before cleaning.

### TESTS & CERTIFICATIONS

EU:  
IEC 60598-1 and IEC 60598-2-4  
Low Voltage Directive (LVD) - 2014/35/EU  
ECO Design Directive - 245/2009/EC  
ROHS Directive - 2011/65/EU amended RoHS 3 Directive 2015/863  
REACH Directive - EC/1907/2006  
WEEE Directive - 2012/19/EU

UK:  
BS EN 60598-1 and EN 60598-2-4  
Electrical Equipment (Safety) Regulations 2016  
Electromagnetic Compatibility Regulations 2016  
The Restriction of the Use of Certain Hazardous Substances in Electrical and Electronic Equipment Regulations 2012  
The Ecodesign for Energy-Related Products and Energy Information (Amendment) (EU Exit) Regulations 2019  
The Eurasian Economic Union:  
TP TC 004 and TP TC 020

USA/Canada:  
UL STD. 153 / CSA STD. C22.2 NO.250.4

## POST WALL LAMP

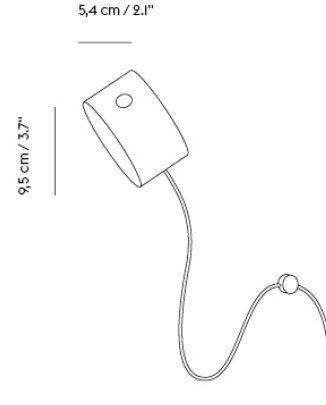

**Shipper Colli** 1  
**Gross Weight (kg)** 1.05  
**Net Weight (kg)** 0.55  
**Warranty Period** 5 years

Item No.	Color	Contract Price	Lead Time
<b>Ready-To-Ship</b>			
22381	Black	SEK 2.536,10	-
<b>Extras</b>			
22509	Extra Wall Mount - Black	SEK 210,70	-
22499	Extra Cable Drops - Black	SEK 270,90	-
22382	Extra Lighting Unit - Black	SEK 2.192,10	-

## POST FLOOR LAMP

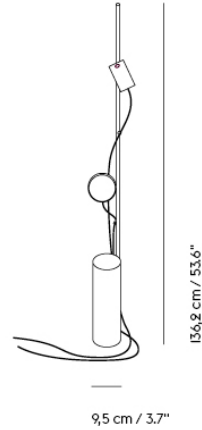

**Shipper Colli** 1  
**Gross Weight (kg)** 11.4  
**Net Weight (kg)** 8.579  
**Warranty Period** 5 years

Item No.	Color	Contract Price	Lead Time
<b>Ready-To-Ship</b>			
22600	Black	SEK 6.015,70	-
<b>Extras</b>			
22386	Extra Cable Drops - Black	SEK 270,90	-
22382	Extra Lighting Unit - Black	SEK 2.192,10	-



## RIME PENDANT LAMP

"Designing simple things is often one of the hardest things to do. We wanted to create a simple lamp with a glass shape, giving it a soft expression while making its top and pendant tube as subtle as possible. We were inspired by the shape of acorns for the gentle lines of the pendant while hinting towards the shaded expression of ice and rime for the glass of the design, allowing for the light to shine slightly through with a refined touch. The Rime Pendant Lamp brings a timeless yet modern perspective to the archetypal light through its translucent shade and graphic form."

— TAF Studio

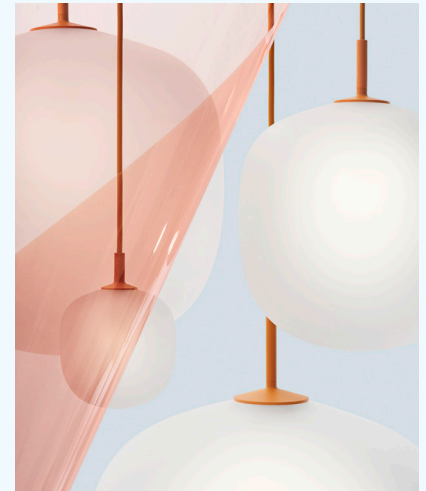

Designed by	TAF Studio / 2020
Environment	Indoor
Country of Production	Poland
Cord Length	400 cm / 157.5"
Bulb Included	Ø12 and Ø18: Yes / Ø25, Ø37 and Ø45: No
Dimmable Function	Yes - If dimmable bulb is used
Socket Size	Ø12 and Ø18: G9 / Ø25: E14 / Ø37 and Ø45: E27
Ceiling Cap Included	Yes - for pendant lamp Ø12, Ø18 and Ø25: Ø9 / 3.5" H 5,6 cm / 2.2 Ø37 and Ø45: Ø11 / 4.3" H 3,5 / 1.4"
Description	The Rime Lamp Series brings an elegant perspective to the glass light through its semitransparent glass that has been sandblasted for a refined expression. The design features a characteristic form, inspired by the shape of acorns, complemented by its powder coated elements for a subtle touch. Kindly note that the availability of sizes and/or colors of this product are subject to regional stock levels.
Material	Pendant: Mouth-blown glass shade. Aluminum, powder coated top-piece and pendant tube. PVC cord.  Wall lamp: Mouth-blown glass shade. Consol arm in aluminum, pressure die-casted and powder coated.  Wall bracket in steel and chrome plated.
Cleaning & Care	Clean with a moist cloth. If necessary, use a little dish soap on the cloth. Always switch off the electricity supply before cleaning.

## RIME PENDANT LAMP

### TESTS & CERTIFICATIONS

#### EU:

IEC 60598-1 and IEC 60598-2-1

Low Voltage Directive (LVD) - 2014/35/EU

ECO Design Directive - 245/2009/EC

ROHS Directive - 2011/65/EU amended RoHS 3 Directive 2015/863

REACH Directive - EC/1907/2006

WEEE Directive - 2012/19/EU

#### UK:

BS EN 60598-1 and BS 4533-102.1, EN 60598-2-1

Electrical Equipment (Safety) Regulations 2016

Electromagnetic Compatibility Regulations 2016

The Restriction of the Use of Certain Hazardous Substances in Electrical and Electronic Equipment Regulations 2012

The Ecodesign for Energy-Related Products and Energy Information (Amendment) (EU Exit) Regulations 2019

#### USA/Canada\*:

UL STD. 1598 / CSA STD. C22.2 NO.250.0

#### Australia/New Zealand\*\*:

AS/NZS 60598.1 and AS/NZS 60598.2.1

\* Does not apply to Rime Ø12 and Rime Wall

\*\* Does not apply to Rime Wall

# 24% rabatt ska dras av på angivna priser

## RIME WALL LAMP

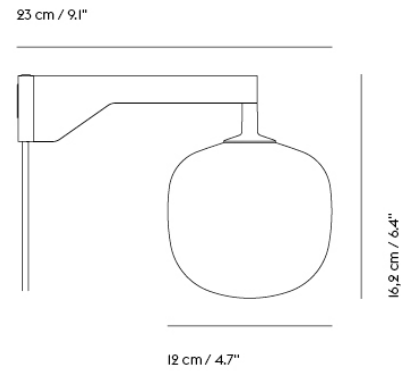

Shipper Colli	1
Gross Weight (kg)	0.694
Net Weight (kg)	0.3
Warranty Period	5 years

Item No.	Color	Contract Price	Lead Time
<b>Ready-To-Ship</b>			
22427	Black	SEK 3.005,70	-
22428	Grey	SEK 3.005,70	-
22429	Orange	SEK 3.005,70	-
22426	White	SEK 3.005,70	-

## TIP LAMP SERIES

"The Tip Lamp Series is a simplistic and friendly design featuring a characteristic architectural silhouette. During the design process, we focused on polishing every single detail alongside the design's functionality. I wanted to reduce the design to the very essence of its purpose—intending to create a product that anyone would understand and be able to use in their daily lives. Its molded body gives the Tip Lamp Series a clean and precise look, highlighting its appearance of quality."

— Jens Fager



Designed by	Jens Fager / 2017 and 2020
Environment	Indoor
Country of Production	China
Cord Length	250 cm / 98.5"
Bulb Included	Yes - integrated LED
Dimmable Function	Yes
Description	Created from the idea of stripping a design down to its essentials, the Tip Lamp Series is an example of simple, functional design with careful attention to detail. Offering direct as well as ambient light, the lamp's adjustable head feature an opal diffuser and dimmer function that effortlessly alters the volume of light.
Material	Casted and extruded aluminum. It has a build-in energy-efficient LED bulb with a Lumen Maintenance (Lifetime) of L90 BIO 35.000 hours. Cord in PVC.
Cleaning & Care	Clean with soft dry cloth only. Always switch off the electricity supply before cleaning.

### TESTS & CERTIFICATIONS

#### EU:

Tip Table / Tip Floor: IEC 60598-1 and IEC 60598-2-4

Tip Wall: IEC 60598-1 and IEC 60598-2-1

Low Voltage Directive (LVD) - 2014/35/EU

ECO Design Directive - 245/2009/EC

ROHS Directive - 2011/65/EU amended RoHS 3 Directive 2015/863

REACH Directive - EC/1907/2006

WEEE Directive - 2012/19/EU

#### UK:

Tip Table / Tip Floor: BS EN 60598-1 and EN 60598-2-4

Tip Wall: BS EN 60598-1 and BS 4533-102.1, EN 60598-2-1

Electrical Equipment (Safety) Regulations 2016

Electromagnetic Compatibility Regulations 2016

The Restriction of the Use of Certain Hazardous Substances in Electrical and Electronic Equipment Regulations 2012

The Ecodesign for Energy-Related Products and Energy Information (Amendment) (EU Exit) Regulations 2019

#### USA/Canada:

Tip Table & Tip Wall: UL STD. I53 / CSA STD. C22.2 NO.250.4

Tip Wall: UL STD. I598 / CSA STD. C22.2 NO.250.0

#### Australia/New Zealand:

Tip Table & Tip Wall: AS/NZS 60598.1 and AS/NZS 60598.2.4

Tip Wall: AS/NZS 60598.1 and AS/NZS 60598.2.1

## TIP TABLE LAMP



Shipper Colli	1
Gross Weight (kg)	2.35
Net Weight (kg)	1.5
Warranty Period	5 years

Item No.	Color	Contract Price	Lead Time
<b>Ready-To-Ship</b>			
22321	Black	SEK 2.536,10	-
22323	Copper Brown	SEK 2.536,10	-
22320	Grey	SEK 2.536,10	-
22322	White	SEK 2.536,10	-

# 24% rabatt ska dras av på angivna priser

## TIP FLOOR LAMP

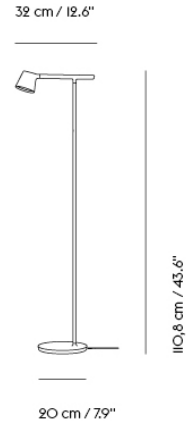
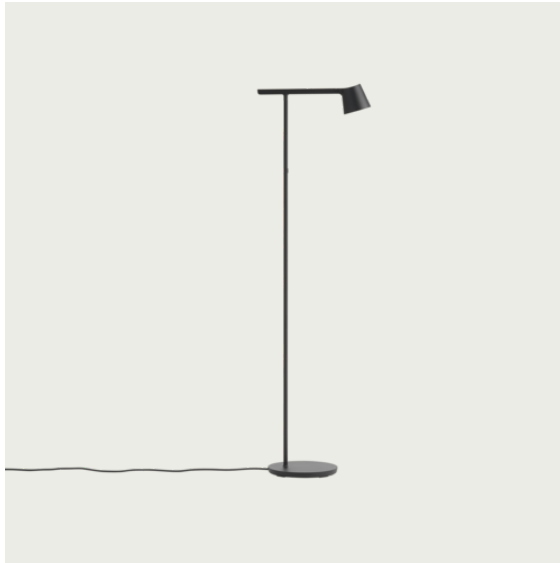

Shipper Colli 1  
Gross Weight (kg) 5.313  
Net Weight (kg) 2.6  
Warranty Period 5 years

Item No.	Color	Contract Price	Lead Time
<b>Ready-To-Ship</b>			
22317	Black	SEK 4.037,70	-
22316	Grey	SEK 4.037,70	-
22318	White	SEK 4.037,70	-

24% rabatt ska dras av på angivna priser

TIP WALL LAMP

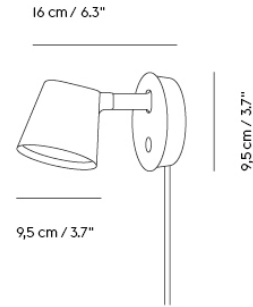

Shipper Colli 1  
Gross Weight (kg) 0.751  
Net Weight (kg) 0.48  
Warranty Period 5 years

Item No.	Color	Contract Price	Lead Time
<b>Ready-To-Ship</b>			
22326	Black	SEK 1.762,10	-
22328	Copper Brown	SEK 1.762,10	-
22325	Grey	SEK 1.762,10	-
22327	White	SEK 1.762,10	-

## MATERIAL TEXTURES

At Muuto, we use an expanded breadth of materials to express our ideas of new perspectives on Scandinavian design. Working with leading suppliers across the world, we strive to use materials that embody our quality standards to provide designs that'll pass the test of time and bring a modern touch to any space at one and the same time. Explore the various textures of materials that are used throughout the Muuto universe.

### WOOD



Ash

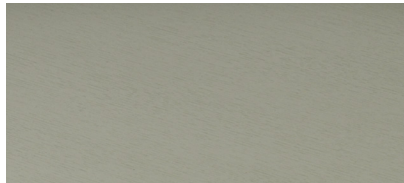

Full Colored Lacquered Oak



Lacquered MDF



Oak Veneer



Solid Oak, Natural Oil



Solid Oak White Pigmented Oil



Oregon Pine

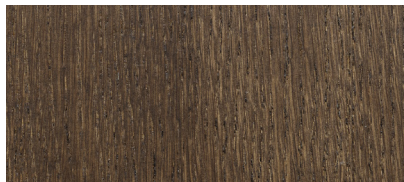

Stained Dark Brown Oak Veneer

### STONE ACRYLIC COMPOSITE

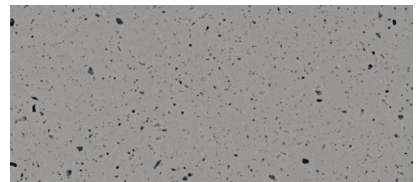

### PLASTIC & WOOD COMPOSITE

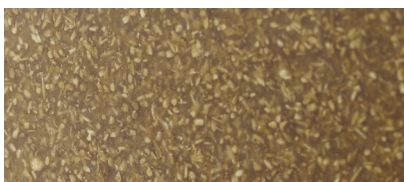

Bamboo Wood & Plastic Composite

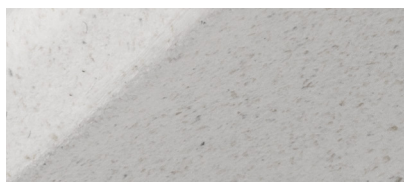

Wood & Plastic Composite

### RECYCLED PLASTIC

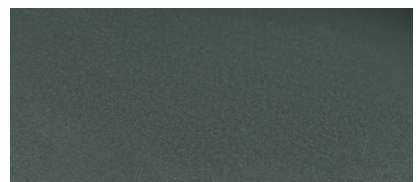



# 24% rabatt ska dras av på angivna priser

## METAL

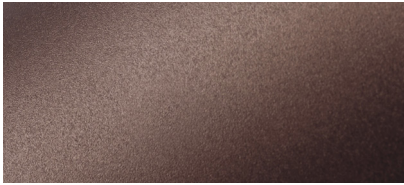

Anodized Aluminum



Lacquered Steel

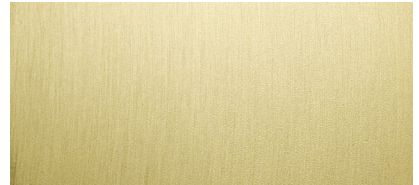

Solid Brass Aluminum



Lacquered Aluminum

## POLYMER FELT

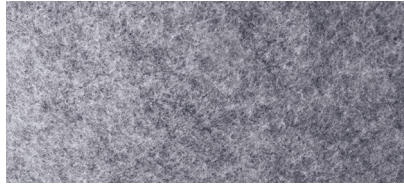

## SILICONE RUBBER



## LINOLEUM



## LAMINATE

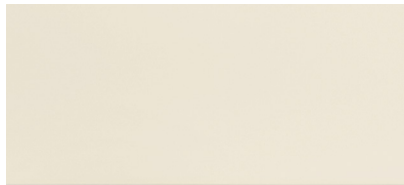

## NANOLAMINATE

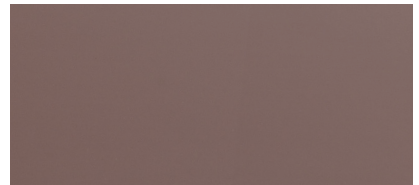

## CERAMICS



## CORK



## COLOR CODE INDEX

### PRODUCT

Ambit Wall Lamp L37 - Black  
 Ambit Wall Lamp L37 - Grey  
 Ambit Wall Lamp L37 - Taupe  
 Ambit Wall Lamp L37 - White  
 Control Lamp - Black  
 Control Lamp - Grey  
 Control Lamp - Red  
 Control Lamp - White  
 Ease Portable Lamp - Black  
 Ease Portable Lamp - Grey  
 Ease Portable Lamp - Light Blue  
 Ease Portable Lamp - Taupe  
 Focus Table Lamp - Black  
 Leaf Lamp - Large - Black  
 Leaf Lamp - Large - Copper Brown  
 Leaf Lamp - Large - Dark Green  
 Leaf Lamp - Large - Grey  
 Leaf Lamp - Large - White  
 Leaf Lamp - Small - Black  
 Leaf Lamp - Small - Copper Brown  
 Leaf Lamp - Small - Dark Green  
 Leaf Lamp - Small - Grey  
 Leaf Lamp - Small - White  
 Linear - Table Lamp - Black - EU  
 Linear - Table Lamp - Grey - EU  
 Post - Floor Lamp  
 Post - Wall Lamp  
 Rime Wall - Black  
 Rime Wall - Grey  
 Rime Wall - Orange  
 Rime Wall - White  
 Tip Floor Lamp - Black  
 Tip Floor Lamp - Grey  
 Tip Floor Lamp - White  
 Tip Table Lamp - Black  
 Tip Table Lamp - Copper Brown  
 Tip Table Lamp - Grey  
 Tip Table Lamp - White  
 Tip Wall Lamp - Black  
 Tip Wall Lamp - Copper Brown  
 Tip Wall Lamp - Grey  
 Tip Wall Lamp - White

### COLOR CODES

EXTERIOR: Black (RAL 7021), INTERIOR: White (RAL 9016)  
 EXTERIOR: Grey (RAL 7040), INTERIOR: White (RAL 9016)  
 EXTERIOR: Taupe (NCS S 6005-Y5OR), INTERIOR: White (RAL 9016)  
 EXTERIOR: White (RAL 9016), INTERIOR: White (RAL 9016)  
 Black  
 Grey (Pantone 7534 C)  
 Red (Pantone 7619 C)  
 White (RAL 9016)  
 RAL 9011  
 RAL 7044  
 NCS S 2020-R90B  
 RAL 7006  
 Black (RAL 9017)  
 RAL 9011  
 Copper Brown (RAL 8004)  
 Dark Green (RAL 6012)  
 RAL 7040  
 RAL 9016  
 Black (RAL 9011)  
 Copper Brown (RAL 8004)  
 Dark Green (RAL 6012)  
 RAL 7040  
 White (RAL 9016)  
 RAL 9011  
 RAL 7044  
 RAL 9011  
 RAL 9011  
 RAL 9011  
 RAL 7044  
 RAL 2000  
 RAL 9016  
 RAL 9011  
 RAL 7044  
 RAL 9016  
 Black (RAL 9011)  
 Copper Brown (RAL 8004)  
 RAL 7044  
 White (RAL 9016)  
 RAL 9011  
 RAL 8004  
 RAL 7044  
 RAL 9016

### NEAREST MATCH

EXTERIOR: Pantone 426 C, NCS 8505-R8OB, INTERIOR: NCS S 0300-N  
 EXTERIOR: Pantone Cool Grey 7C, NCS 4005-R8OB, INTERIOR: NCS S 0300-N  
 EXTERIOR: Taupe (NCS S 6005-Y5OR), INTERIOR: White (RAL 9016)  
 EXTERIOR: White (RAL 9016), INTERIOR: White (RAL 9016) (close to RAL 7021)  
 RAL Design 090 80 10, NCS S 1505-G90Y  
 RAL Design 040 50 60  
 NCS S 0300-N  
 NCS S 8500-N, Pantone 426 C  
 NCS S 2502-Y, Pantone 401 U  
 RAL 250 70 15, Pantone 2155 C  
 NCS S 6005-Y2OR, Pantone 404 C  
 Pantone Black C, NCS S 9000-N  
 NCS S 9000-N, Pantone 426 C  
 Pantone 1685 C, NCS S 5040-Y6OR  
 -  
 NCS S 4005-R8OB, Pantone Cool Grey 7C  
 NCS S 0300-N  
 NCS S 9000-N, Pantone 426 C  
 Pantone 1685 C, NCS S 5040-Y6OR  
 -  
 NCS S 4005-R8OB, Pantone Cool Grey 7C  
 NCS S 0300-N  
 -  
 -  
 NCS S 9000-N, Pantone 426 C  
 NCS S 9000-N, Pantone 426 C  
 -  
 -  
 -  
 -  
 Pantone 426 C, RAL Design 000 15 00  
 -  
 NCS S 0500-N  
 Pantone 426 C, RAL Design 000 15 00  
 Pantone 1685 C, NCS S 5040-Y6OR  
 -  
 NCS S 0500-N  
 Pantone 426 C, RAL Design 000 15 00  
 Pantone 1685 C, NCS S 5040-Y6OR  
 -  
 NCS S 0500-N

## TEXTILE OPTIONS

Striving to work with the best suppliers, the textiles used for Muuto products are by four different companies: Danish Kvadrat and Swedish Nevotex along with both Arve from Italy and Rohlede from Germany—all suppliers that have been selected on the basis of their extensive knowledge within the field and state-of-the-art material qualities.

\*Upholstered Muuto products that have the Declare Living Building Challenge Compliant certification only have the certification when upholstered with the following Kvadrat textiles: Canvas, Clara, Divina, Divina MD, Divina Mélange, Fiord, Hallingdal, Remix, Rime, Steelcut, Steelcut Trio and Vidar.



### BALDER BY KVADRAT

Designer: Fanny Aronsen.

Composition: 68% new wool, 26% cotton, 6% nylon.

Durability: 100.000 Martindale / Lightfastness 6.

Sustainability: Natural fibres / Sustainable resource. Complies with Greenguard Gold Certification.



132

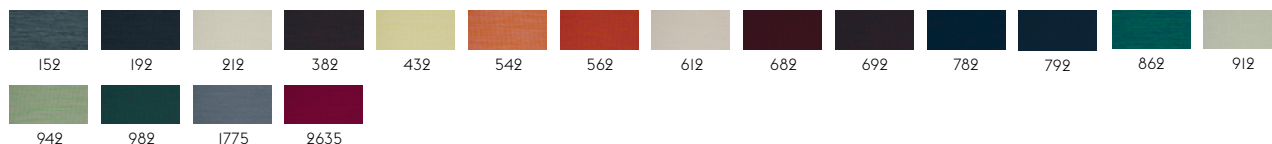

### CANVAS BY KVADRAT

Designer: Giulio Ridolfo.

Composition: 90% new wool worsted, 10% nylon.

Durability: 100.000 Martindale / Lightfastness 5-7 (ISO 1-8).

Sustainability: Complies with both EU ecolabel "The Flower" and Greenguard Gold Certification.



114

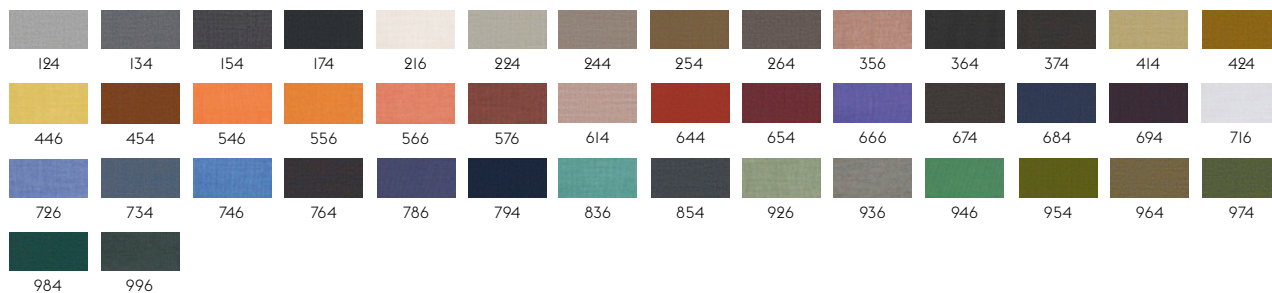

### CLARA BY KVADRAT

Designer: Anne Birgitte Hansen.

Composition: 92% new wool worsted.

Durability: 80.000 Martindale.

Sustainability: Complies with both EU ecolabel "The Flower" and Greenguard Gold Certification.

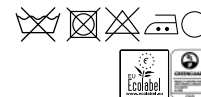

144

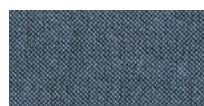
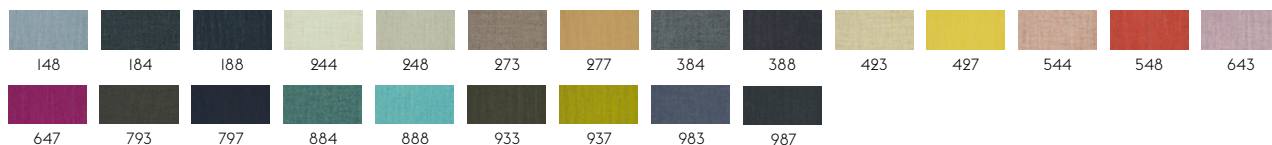

### CLAY BY KVADRAT

Designer: Vincent Van Duysen for Kvadrat.

Composition: 76% Linen, 21% Cotton, 3% Polyester.

Durability: 45.000 Martindale / Lightfastness 4-6.

Sustainability: Complies with Greenguard Certification.



1

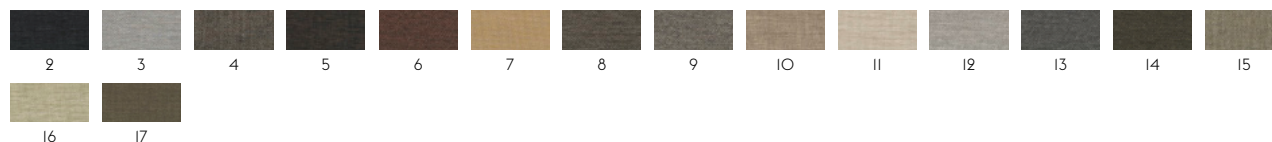

### COLLINE BY KVADRAT

Designer: Frans Dijkmeijer

Composition: 75% New Wool, Worsted, 17% polyacrylic, 8% Nylon

Durability: 100.000 Martindale / Lightfastness 7

Sustainability: Greenguard Gold, HPD, EPD



127



# 24% rabatt ska dras av på angivna priser



## DIVINA BY KVADRAT

Designer: Finn Sködt.

Composition: 100% new wool.

Durability: 45.000 Martindale / Lightfastness 5-6.

Sustainability: Complies with both EU ecolabel "The Flower" and Greenguard Gold Certification.

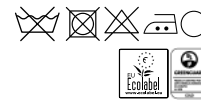

106

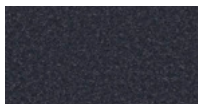
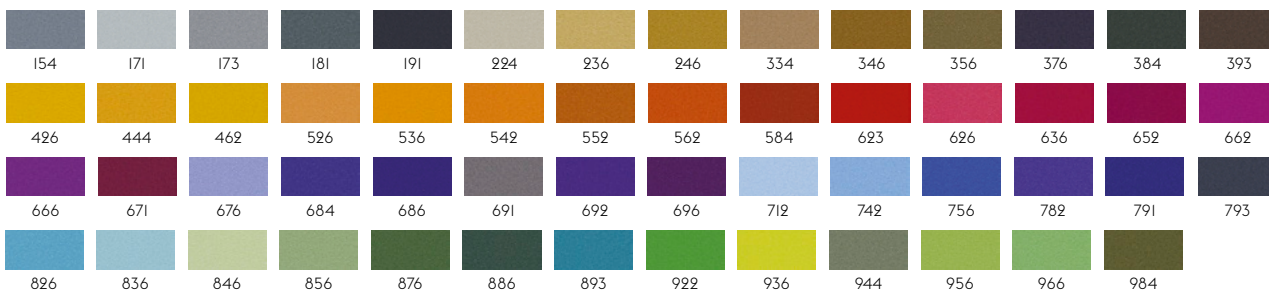

## DIVINA MD BY KVADRAT

Designer: Finn Sködt.

Composition: 100% new wool.

Durability: 45.000 Martindale / Lightfastness 5-6 (ISO 1-8).

Sustainability: Complies with both EU ecolabel "The Flower" and Greenguard Gold Certification.



193

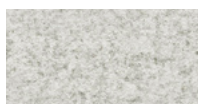
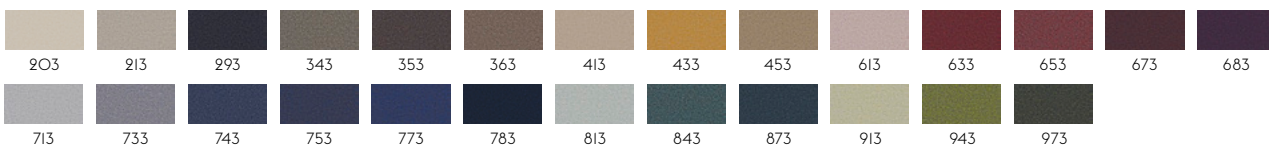

## DIVINA MELANGE BY KVADRAT

Designer: Finn Sködt.

Composition: 100% new wool.

Durability: 45.000 Martindale / Lightfastness 6-7.

Sustainability: Complies with both EU ecolabel "The Flower" and Greenguard Gold Certification.



120

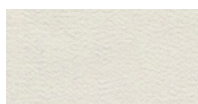
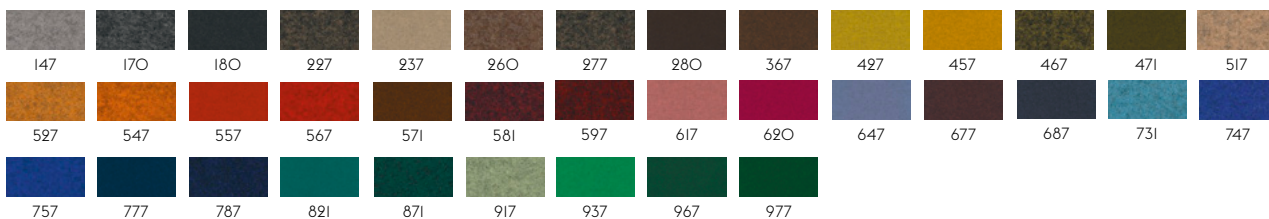

## ECRITURE BY KVADRAT

Designer: Sahco.

Composition: 40% polyacrylic, 27% polyester, 18% viscose, 9% linen, 6% cotton.

Durability: 70.000 Martindale / Lightfastness 6.

Sustainability: Complies with Greenguard Gold Certification.



0100



## FIORD BY KVADRAT

Designer: Tone Barnung & Louise Sigvardt.

Composition: 92% new wool worsted, 8% nylon.

Durability: 60.000 Martindale / Lightfastness 5-6.



101

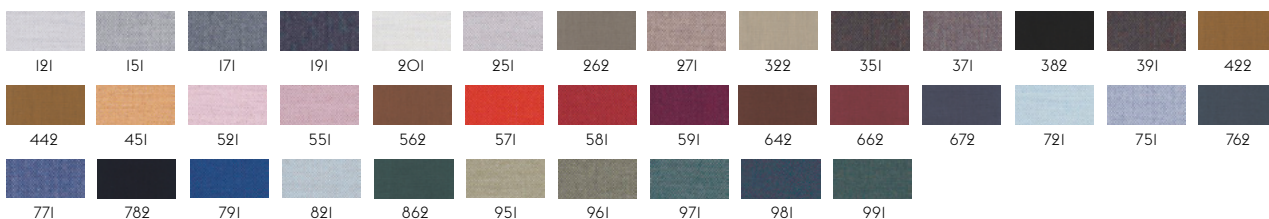



### HALLINGDAL 65 BY KVADRAT

Designer: Nanna Ditzel.

Composition: 70% new wool, 30% viscose.

Durability: 100.000 Martindale / Lightfastness 6-7.

Sustainability: Complies with both EU ecolabel "The Flower" and Greenguard Gold Certification.



100

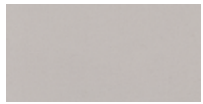
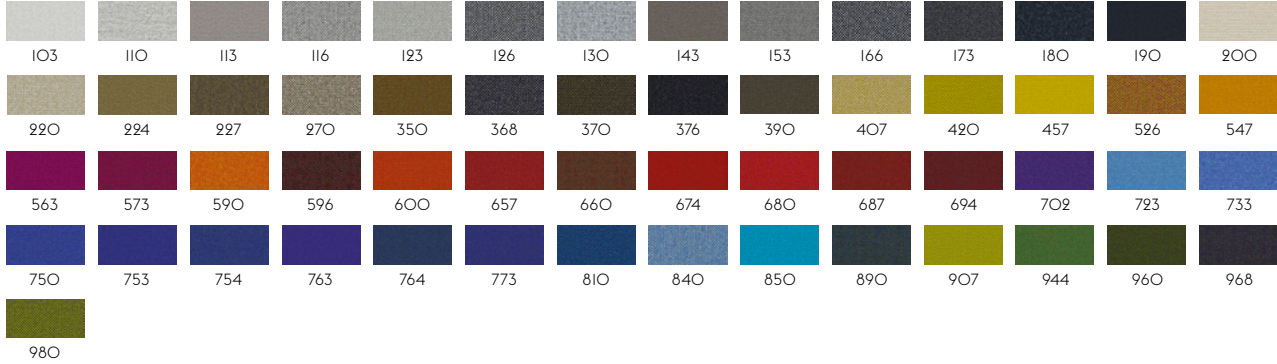

### HERO BY KVADRAT

Designer: Patricia Urquiola.

Composition: 96% new wool, 4% nylon.

Durability: 45.000 Martindale / Lightfastness 5-6.

Sustainability: Complies with EU ecolabel "The Flower".

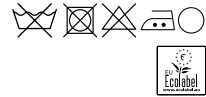

102

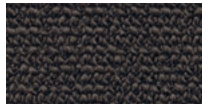
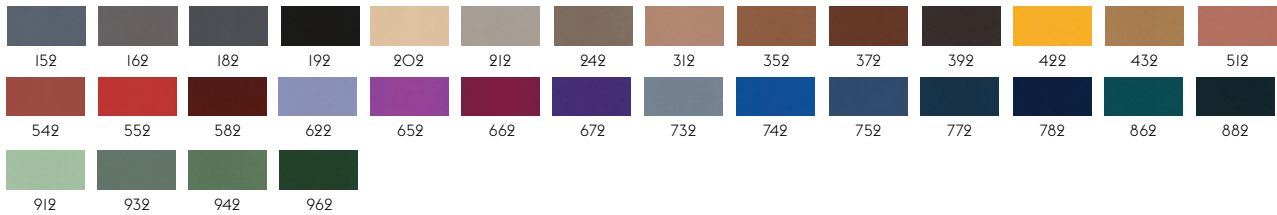

### OCEAN BY ROHLER

Designer: Rohleder.

Composition: 74% Polyacrylic / 26% Polyester.

Durability: 30.000 Martindale / Lightfastness 5-7 (ISO I-8).



3



### PLANUM BY KVADRAT

Designer: Raw Color.

Composition: 44% new wool, 42% polyester, 14% nylon.

Durability: 100.000 Martindale / Lightfastness 5-6 (ISO I-8).

Sustainability: Complies with Greenguard Certification.

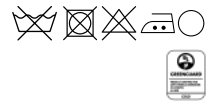

111

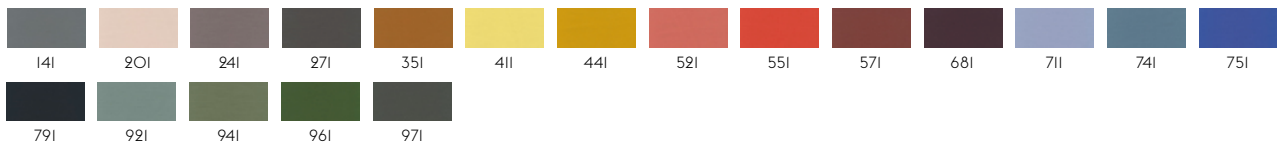

### RE-WOOL BY KVADRAT

Designer: Margrethe Odgaard.

Composition: 45% new wool worsted, 45% recycled wool, 10% nylon.

Durability: 100.000 Martindale / Lightfastness 5-7 (ISO I-8).

Sustainability: Complies with both EU ecolabel "The Flower" and Greenguard Gold Certification.

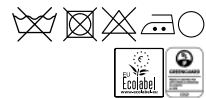

108

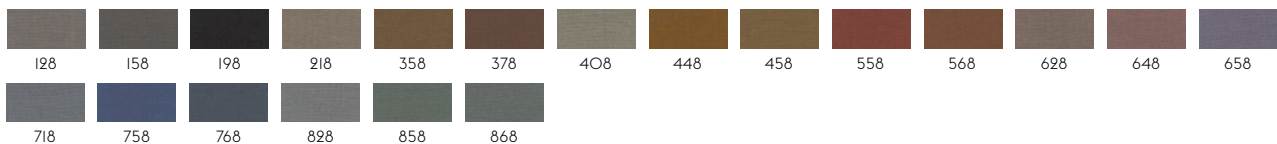

# 24% rabatt ska dras av på angivna priser



## REMIX BY KVADRAT

Designer: Giulio Ridolfo.

Composition: 90% new wool worsted, 10% nylon.

Durability: 100,000 Martindale / Lightfastness 5-7 (ISO 1-8).

Sustainability: Complies with both EU ecolabel "The Flower" and Greenguard Gold Certification.

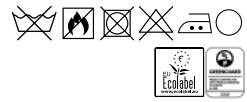

113

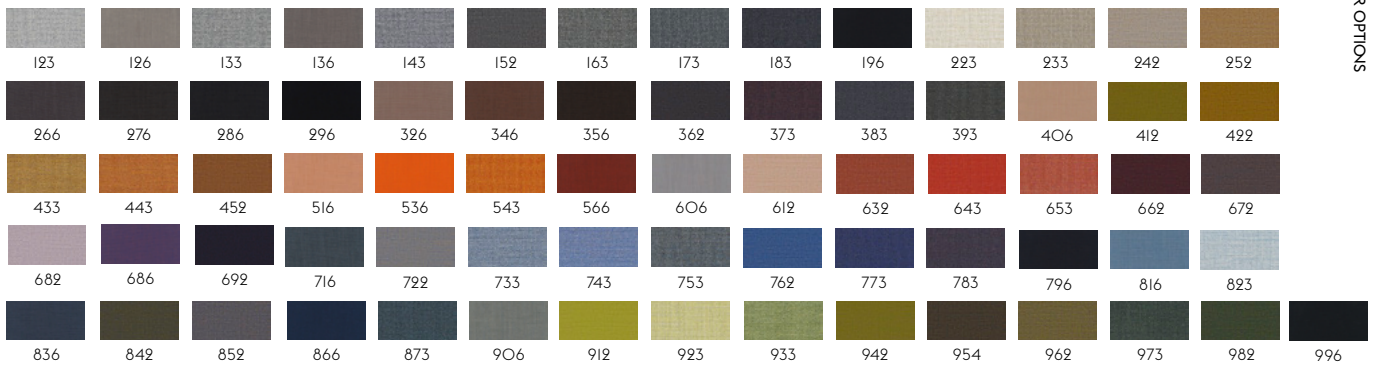

## RIME BY KVADRAT

Designer: Åsa Pärson.

Composition: 90% new wool worsted, 10% nylon.

Durability: 100,000 Martindale / Lightfastness 5-7 (ISO 1-8).

Sustainability: Complies with both EU ecolabel "The Flower" and Greenguard Gold Certification.

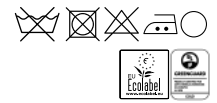

111

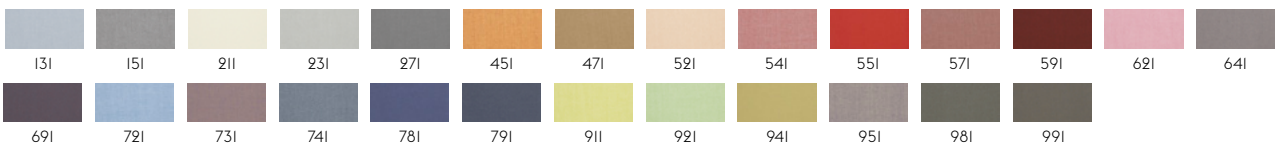

## SABI BY KVADRAT

Designer: Louise Sigvardt

Composition: 65% New Wool, Worsted, 23% Recycled Wool, 12% Nylon

Durability: 80,000 Martindale / Lightfastness 5-7

Sustainability: Greenguard Gold, HPD, EPD

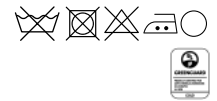

121

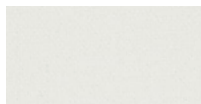
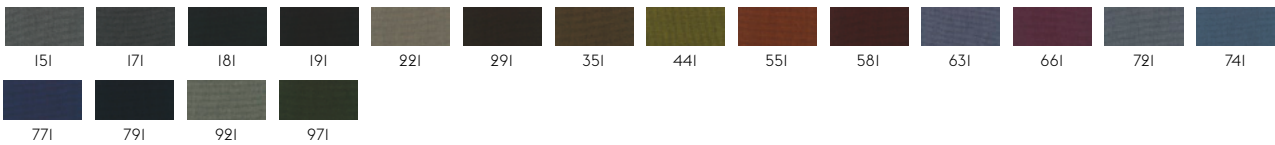

## STEELCUT BY KVADRAT

Designer: Dijkmeijer & Ridolfo.

Composition: 90% new wool worsted, 10% nylon.

Durability: 80,000 Martindale / Lightfastness 5-7 (ISO 1-8).

Sustainability: Complies with both EU ecolabel "The Flower" and Greenguard Gold Certification.



110

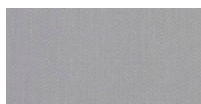
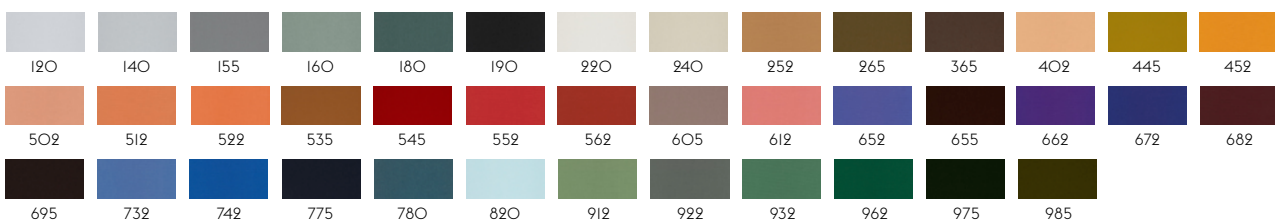

## STEELCUT TRIO BY KVADRAT

Designer: Dijkmeijer & Ridolfo.

Composition: 90% new wool worsted, 10% nylon.

Durability: 100,000 martindale / Lightfastness 5-7 (ISO 1-8).

Sustainability: Complies with both EU ecolabel "The Flower" and Greenguard Gold Certification.

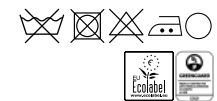

105

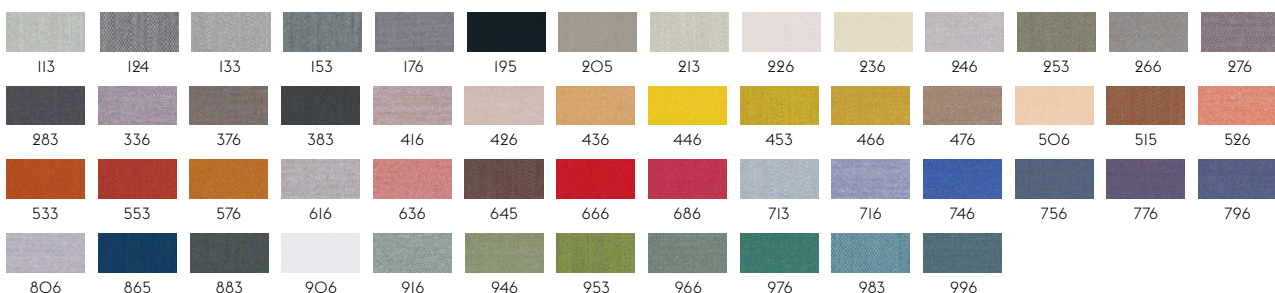

# 24% rabatt ska dras av på angivna priser

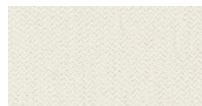

## STILL BY KVADRAT

Designer: Georgina Wright.  
Composition: 100% Trevira CS.  
Durability: 50.000 Martindale / Lightfastness: 6



III

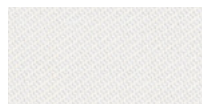
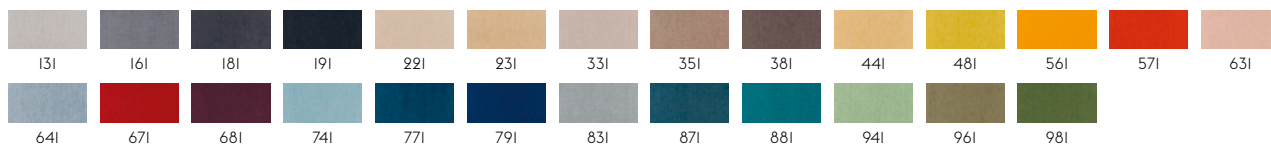

## TWILL WEAVE BY KVADRAT

Designer: Jonathan Olivares.  
Composition: 90% new wool (worsted), 10% nylon.  
Durability: 60.000 Martindale / Lightfastness 5-7 (ISO I-8).  
Sustainability: Complies with both EU ecolabel "The Flower" and Greenguard Gold Certification.



IIO

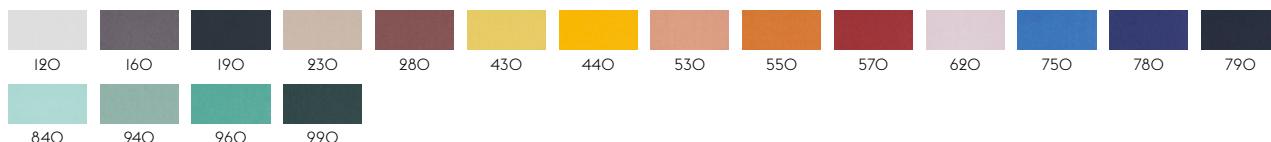

## VANCOUVER BY ROSSINI DELLA QUERCIA

Designer: Gabriella Zecca  
Composition: 52% cotton, 48% acrylic.  
Durability: 40.000 Martindale / Lightfastness 4-5.



4

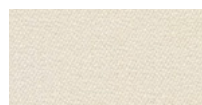

## VIDAR BY KVADRAT

Designer: Raf Simons & Fanny Aronsen for Kvadrat.  
Composition: 94% new wool, 6% nylon.  
Durability: 100.000 Martindale / Lightfastness 6-7.  
Sustainability: Natural fibres / Sustainable resource. Complies with Greenguard Gold Certification.

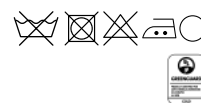

IO6

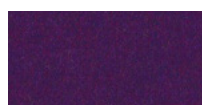
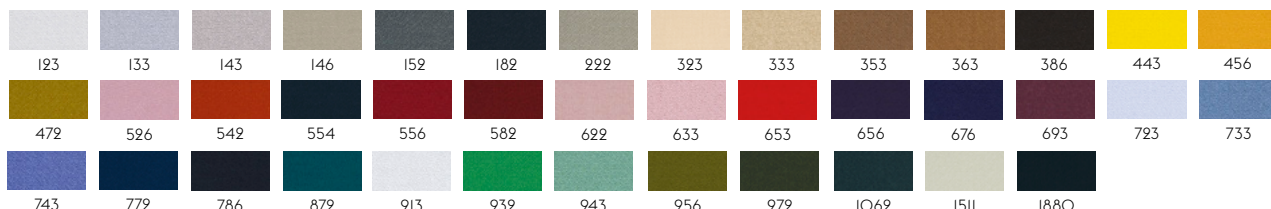

## WOOLY BY NEVOTEX

Designer: Nevotex  
Composition: 70% wool, 25% polyamide, 5% other fibres.  
Durability: 150.000 Martindale / Lightfastness 6-8.



OO91

Wooly is woven in 70% recycled wool, sourced from leftover materials of clothing production and other wool products. One kilo of pure new wool generates 9 kilograms of carbon dioxide when produced while processing one kilo of recycled wool only generates 0.5 kilograms of carbon dioxide. Furthermore, recycled wool has a positive environmental impact due to lessened water consumption and lower energy consumption.

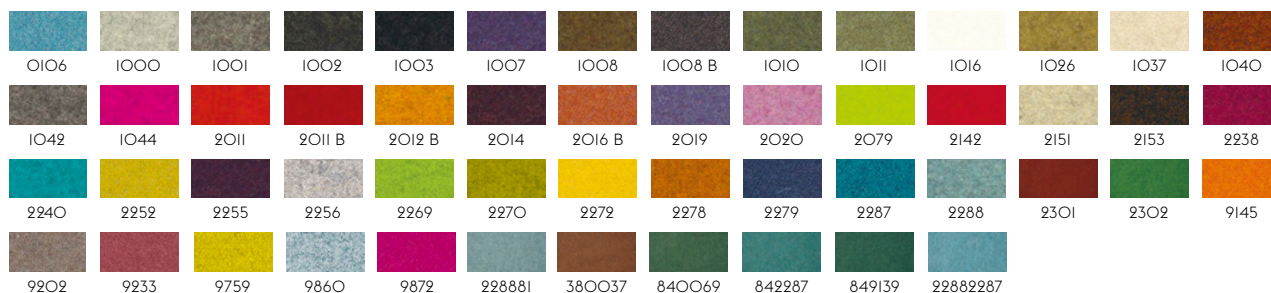

## LEATHER OPTIONS

At Muuto, we work with some of the leading European leather suppliers to ensure that the leather used for our designs is always of the highest possible standard. Our leather options range from the Refine Leather, a modern and sleek full-grain leather with a soft touch, over Easy Leather, a lightly buffed natural grain leather with a soft and waxy feel along with a matte look, to our Endure Leather, a pliable and extremely durable semi-aniline leather ideal for hard contract environments.



### EASY LEATHER

Lightly Buffed Natural Grain Leather  
Raw material: Designed and processed in Italy. The leather is dyed through, chrome tanned and finishing is with resins and pigments.

ZINC

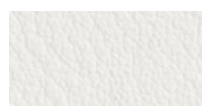
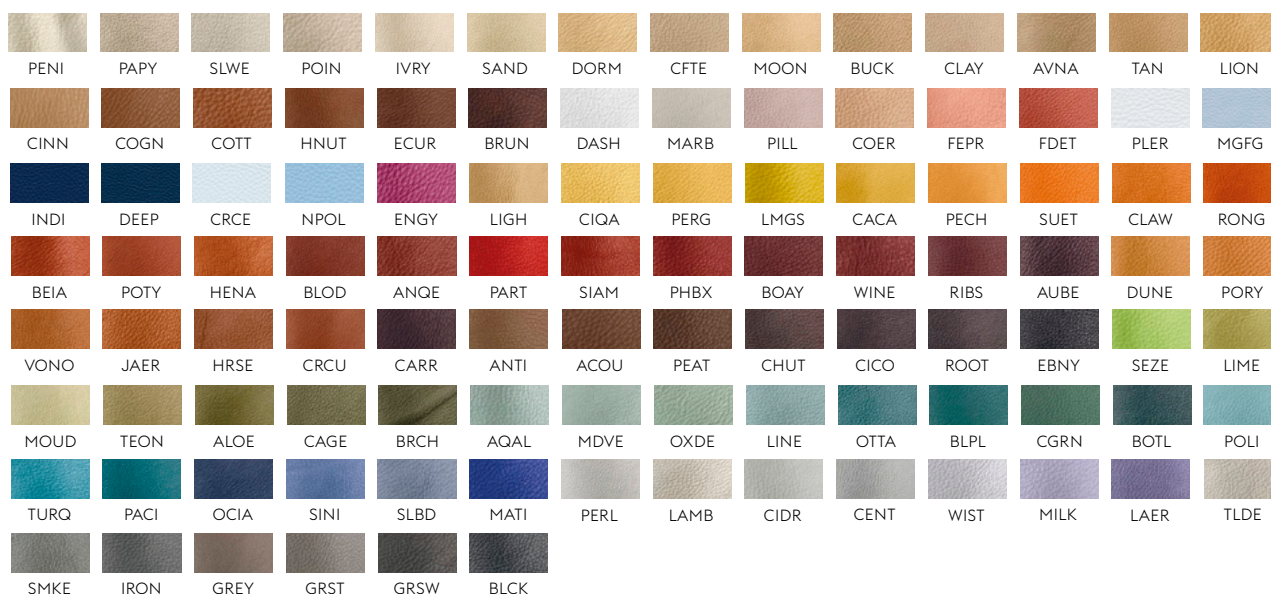

### ENDURE LEATHER

Semi-aniline leather with high durability, making it ideal for contract environments.  
Raw material: Leather from Scandinavian raw hides.  
The leather is dyed through a chrome free tanning process. Also available in custom colors in a minimum of 1 hide.

CWIT

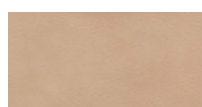

### REFINE LEATHER

Aniline Leather.  
Raw material: Grain leather from European raw hides. The leather is dyed through, chrome tanned and produced without the use of PCP and CFC which can be damaging to the environment.

CREM

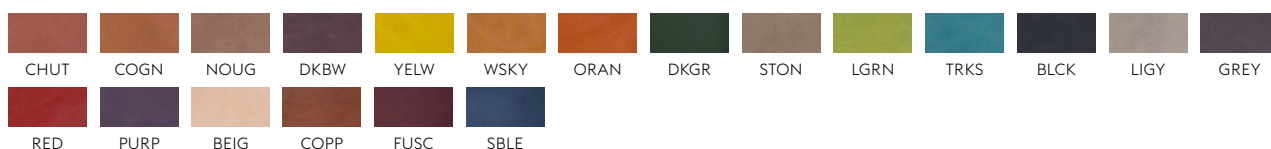



## GENERAL TERMS OF SALE AND DELIVERY

### VALIDITY

These General Terms of Sale and Delivery shall supersede and suspend all previous agreements and shall apply to any agreement made between Muuto and the buyer unless otherwise agreed.

### SALES AND MARKETING MATERIAL

Information supplied by Muuto regarding prices, models, dimensions, features, and specifications in catalogues, advertisements, sales or promotional literature, price lists or elsewhere is not legally binding and shall be considered for guidance only, and may be changed at any time without prior notice.

### ORDERS

All orders placed by the buyer must be in writing and shall at the minimum specify the type (product number and/or name) and quantity of the products ordered as well as the requested date of delivery. The order is not binding upon Muuto unless and until Muuto has issued a written order confirmation to the buyer. Unless objections are made within 24 hours after receipt, the order confirmation is considered accepted by the buyer.

For customers on prepayment terms Muuto will start production of made-to-order products immediately when prepayment has been received.

### PRICES

The present price list replaces all previous price lists and may be subject to changes at any time without prior notice. The purchase price for the products ordered by the buyer is stated in the order confirmation. Delivery and installation is not included in the purchase price. Unless otherwise agreed, quotations submitted by Muuto shall be valid and binding for 60 days after receipt.

### DELIVERY

Unless otherwise agreed in writing, delivery shall be ex. works (Incoterms 2020) from the place designated by Muuto from time to time. If transportation of the products is handled by Muuto's forwarding agent on behalf of the buyer, Muuto will invoice the freight to the buyer. The products shall be sent using standard packaging. The confirmed delivery date is only an estimated delivery date and the time of delivery shall not be considered of essence. Muuto cannot be held liable for any damage or loss that the buyer may suffer as a result of a delay or a non-delivery. If no specific delivery date has been indicated in the order confirmation, Muuto, acting reasonably, is entitled to stipulate a delivery date taking into consideration the quantity and the nature of the products to be delivered.

The buyer is always obliged to inspect the products delivered upon receipt, i.e. checking that the correct type of products has been delivered, and checking that the correct quantity of the products has been delivered.

Should a delivery fail to meet the buyer's expectations, or is the delivery damaged during transportation, the buyer shall:

1. Inspect the entire delivery immediately.
2. Accept the delivery, but immediately note the damage on the freight documents by stating, "Received with reservation".
  1. If freight document does not allow for reservations, the buyer is expected to refuse the delivery.
3. Report the extent of the damages to Muuto according to the paragraph "Filing Complaints"

The buyer is deemed to have accepted the products delivered unless a claim has been filed within 5 working days upon receipt in accordance with the instructions in the paragraph "Filing Complaints".

### PAYMENT AND RETENTION OF TITLE

Unless otherwise agreed, payment shall be made in accordance with the payment terms and conditions of payment indicated on the invoice and the order confirmation. All bank charges are the responsibility of the buyer. All products not paid for in the full, including interest and delivery (if any), shall remain the property of Muuto. The buyer shall at all times keep such products separated from any other products held in stock, and must ensure that the products can at all times be identified by Muuto. The buyer shall be liable to Muuto for any damage to the products until they have been paid for in full as stated above. There will be a penalty interest of 2% per month when payment is made after the due date. Such interest is payable without any further notice. Prepayment of proforma invoice is required for buyers without credit. The buyer must state account number as well as the proforma invoice number on the payment.

**MUUTO**

## WARRANTY AND LIMITATION OF LIABILITY

Muuto offers a warranty against defects of manufacture and materials on standard products. The warranty listed in Muuto's current pricelist shall be valid from the date of delivery provided that the products are used under normal circumstances and maintained according to guidelines. Excluded from this warranty are all defects due to or caused by transport, incorrect use, inadequate maintenance, accidents, the buyer's alteration or repair, modification of the product (incl. certification through 3<sup>rd</sup> party) as well as normal wear and tear of the products.

Natural variations in organic materials cannot be considered defects, and Muuto explicitly excludes itself from liability for any such variations. Muuto's warranty against defects of upholstery requires that such upholstery (fabric or leather) is included in the price list and is recommended by Muuto. Should the buyer wish to provide its own upholstery (fabric or leather), or should the buyer wish to itself process (whether by dyeing or otherwise) the upholstery provided by Muuto, Muuto's warranty lapses. Muuto cannot in any way be held responsible for materials delivered by the buyer, including the compliance of such materials with local law of the country or state to which they are delivered, irrespective of whether such materials have been upholstered or otherwise incorporated into Muuto's products by Muuto."

Unless otherwise stated in these General Terms of Sale and Delivery, Muuto is not liable to the buyer for loss of production, loss of use, loss of contracts, loss of profit or for any other consequential or indirect loss whatsoever.

Notwithstanding any other provisions of these General Terms of Sale and Delivery, Muuto's maximum liability in relation to the buyer can in no event exceed the purchase price for the products sold, including any liability for damages to a third party, such as, for example but not limited to, product liability.

## PRODUCT LIABILITY

Mandatory product liability rules in force from time to time shall apply to disputes regarding product liability. Unless otherwise required by mandatory legislation, Muuto shall not be liable to the buyer for any damage or loss caused by the products, including but not limited to liability for loss of production, loss of use, loss of contracts, loss of profit or for any other consequential or indirect loss whatsoever.

The buyer must ensure that any products purchased from Muuto fulfill the legislative requirement, hereunder has the required certifications, in the region or country, where the product is to be used.

If buyer makes any alteration or modification to the product, Muuto shall not be liable to any damage to the product, other objects or property.

## REMEDIES

With respect to products that are defective, Muuto may choose to refund the purchase price for such products, repair such products or replace such products, always provided that it is a condition for such refund, repair or replacement that the buyer has notified Muuto about the defect within reasonable time after the buyer discovered or ought to have discovered it, and provided that such notice is given within the warranty period in accordance with the instructions in the below paragraph "Filing Complaints". Thus, Muuto is not obligated to replace customized or discontinued products.

The above remedies constitute the buyer's only remedies in respect of any defective products delivered under these General Terms of Sale and Delivery.

## FILING COMPLAINTS

A complaint shall be filed by email within 5 days upon delivery and, for quality complaints, within the period of warranty.

Each complaint shall be filed in such a manner that the email describes in detail the problem at hand. Each complaint will be evaluated from the Muuto Claims Department provided that the following is stated and/or enclosed:

1. Delivery note/order confirmation number/invoice number
2. Clear description of the complaint in detail
3. Images of product, up close and from afar
  1. For transport damages: Images of boxes and labelling shall be enclosed by the buyer
  2. For quality complaints: Images of product specific PO-number shall be enclosed by the buyer

## RETURN OF PRODUCTS

Returns are only accepted by prior written agreement. Return products shall be securely and properly packed in their original packaging and return order confirmation shall be placed visible on the package. Unless otherwise agreed, the buyer shall bear the transport cost and risk of any defective products returned to Muuto.

## CHANGES IN DESIGN

Prior to delivery and without prior notice Muuto reserves the right to make any changes to a product's design that is found by Muuto to be necessary or appropriate.

**MUUTO**

## FIRE-RETARDANCY

MUUTO products can be supplied with fire-retardant fabrics. As the regulations vary in each country, we advise all customers to check the respective local regulations. Any requests for fire-retardant treatment must be sent to MUUTO in written form, specifying which fire- retardant norm the products must comply with.

## OTHER

The buyer is not allowed to sell the products to non-authorized re-sellers without written approval by Muuto.

## APPLICABLE LAW AND VENUE

The parties contractual relationship under these General Terms of Sale and Delivery shall be governed and construed by and shall be interpreted in accordance with Danish law, without regard to the United Nations' Convention of Contracts for the International Sale of Goods (CISG). Any dispute that may arise out of the parties' contractual relationship under these General Terms of Sale and Delivery or any related event, which cannot be settled amicably, shall at Muuto's request be brought before the Copenhagen City Court.

## AMENDMENTS

Muuto is entitled to modify these General Terms of Sale and Delivery at any time. Muuto shall notify the buyer of such modifications and of the date of such modification. The buyer is deemed to have accepted the modifications unless written notice of rejection is given to Muuto within 10 working days after receipt of such notice.

**MUUTO**

WHOLESALE PRICE LIST. Wholesale prices are stated excl. VAT. Recommended retail prices include VAT. Prices are valid from [Catalog.PricelistDate!dd-MM-yyyy]. All prices are subject to alteration. MOQ : Minimum order quantity / <MOQ fee: handling fee for orders quantities below MOQ. Start-up fee: sample charge for untested textiles and colors.

24% rabatt ska dras av på angivna priser

Stockholm  
Gävle

Göteborg  
Hedemora

Malmö  
Edsbyn

Uppsala  
Jönköping

Helsingborg  
Sundsvall

Umeå

**SENAB**  
*space for big ideas*