

Muuto Produktlista 1

26%

Statligt ramavtal Möbler och inredning

Delområde G - Armaturer | Ramavtalsnummer 23.3-5834-2022:015



26% rabatt ska dras av på angivna priser

LIGHTING

26% rabatt ska dras av på angivna priser

AMBIT LAMP SERIES

"What defines our attraction to shapes? With the Ambit Lamp Series, we wanted to explore form and proportions in a thorough and meticulous way. We discovered a unique dynamic between linear and rounded shapes that gives the lamp its unique outline, making the Ambit Lamp Series a timeless design that you'll never grow tired of while its handspun aluminum material and contrasting white inner makes for an elegant touch."

— TAF Studio



Designed by	TAF Studio
Environment	Indoor
Country of Production	China
Cord Length	Pendant Lamp and Rail Lamp: 400 cm / 157.5" Wall Lamp: 250 cm / 98.4"
Light Source Included	Pendant Lamp Ø16,5 and Wall Lamp: Yes Pendant Lamp Ø55, Ø40, Ø25 and Rail Lamp: No
Ceiling Cap Included	Pendant Lamp and Rail Lamp: Yes Wall Lamp: No
Dimmable Function	Rail lamp: Yes (can be dimmed with industry standard phasecut dimmers, if dimmable bulb is used) Ambit Ø16,5: Yes (can be dimmed with industry standard phasecut dimmers) Ambit Ø25, Ø40 and Ø55: Yes (can be dimmed with industry standard phasecut dimmers, if dimmable bulb is used)
Socket Size	Ambit Ø25 and Rail Lamp: E14 Ambit Ø40 and Ø55: E27 Ambit Ø16,5 and Wall Lamp: GX53
Description	Embodying the values of Scandinavian design, the Ambit Lamp Series is as timeless as it is contemporary. Made of hand-spun aluminum that has been hand-painted, the Ambit Lamp Series features clean lines and a white interior that heighten contrasts of its outside shade while enhancing the light emitted in any room of a home, office or commercial space. Use the design on its own or symmetric formations and vibrant clusters.
Material	Aluminum lamp shades. Made from old brazer traditions, the lamp shades are press spun by hand. Hereafter, the lamp shades are polished and painted by hand. PVC cord.

26% rabatt ska dras av på angivna priser

AMBIT LAMP SERIES

Cleaning & Care

Rail Lamp:

The rail for the Ambit Rail Lamp is cut from tubes that are adjusted to fit each other on a lathe machine. Rail made from cast and extruded aluminum.

Wall Lamp:

Arm fixture and wall mount piece for the Ambit Wall Lamp are made from aluminum. An extra wall bracket is included in the Ambit Wall Lamp that allows for the wiring to be integrated into the wall.

Clean the lamp with a soft dry cloth. Always switch off the electricity before cleaning.

TESTS & CERTIFICATIONS

EU:

IEC 60598-1 and IEC 60598-2-1

Low Voltage Directive (LVD) - 2014/35/EU

ECO Design Directive - 245/2009/EC

ROHS Directive - 2011/65/EU amended RoHS 3 Directive 2015/863

REACH Directive - EC/1907/2006

WEEE Directive - 2012/19/EU

UK:

BS EN 60598-1 and BS 4533-102.1, EN 60598-2-1

Electrical Equipment (Safety) Regulations 2016

Electromagnetic Compatibility Regulations 2016

The Restriction of the Use of Certain Hazardous Substances in Electrical and Electronic Equipment Regulations 2012

The Ecodesign for Energy-Related Products and Energy Information (Amendment) (EU Exit) Regulations 2019

USA/Canada:

UL STD. 1598 / CSA STD. C22.2 NO.250.0

Australia/New Zealand:

AS/NZS 60598.1 and AS/NZS 60598.2.1

*Does not apply to Ambit Pendant Ø16,5 and Ambit Wall Lamp

China:

GB 7000.201 and GB 7000.1

26% rabatt ska dras av på angivna priser

AMBIT PENDANT LAMP / Ø 16,5 CM / 6.5"



Shipper Colli	1
Gross Weight (kg)	1.0002
Net Weight (kg)	0.69
Bulb included	EU version: yes, US version: no
Warranty Period	5 years

Item No.	Color	Contract Price	Lead Time
Ready-To-Ship			
15354	Black	SEK 1.504,10	-
15353	Dusty Green	SEK 1.504,10	-
15351	Grey	SEK 1.504,10	-
15358	Light Blue	SEK 1.504,10	-
15357	Taupe	SEK 1.504,10	-
15352	White	SEK 1.504,10	-
Extras			
24050	Ceiling Cap - White	SEK 116,10	-

26% rabatt ska dras av på angivna priser

AMBIT PENDANT LAMP / Ø 25 CM / 9.75"

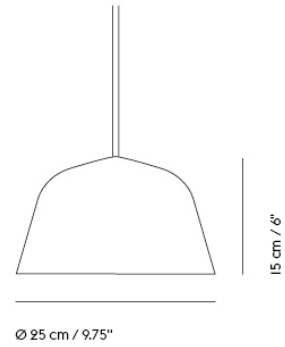

Shipper Colli	1
Gross Weight (kg)	1.1092
Net Weight (kg)	0.7
Bulb included	
Warranty Period	5 years

Item No.	Color	Contract Price	Lead Time
Ready-To-Ship			
26034	Black	SEK 2.192,10	-
26033	Dusty Green	SEK 2.192,10	-
26031	Grey	SEK 2.192,10	-
26038	Light Blue	SEK 2.192,10	-
26037	Taupe	SEK 2.192,10	-
26032	White	SEK 2.192,10	-
Extras			
24050	Ceiling Cap - White	SEK 116,10	-

26% rabatt ska dras av på angivna priser

AMBIT PENDANT LAMP / Ø 40 CM / 15.75"

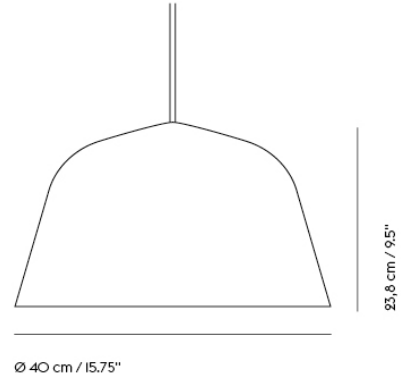

Shipper Colli	1
Gross Weight (kg)	2.9002
Net Weight (kg)	1.53
Bulb included	
Warranty Period	5 years

Item No.	Color	Contract Price	Lead Time
Ready-To-Ship			
26024	Black	SEK 3.482,10	-
26023	Dusty Green	SEK 3.482,10	-
26021	Grey	SEK 3.482,10	-
26028	Light Blue	SEK 3.482,10	-
26025	Rose	SEK 3.482,10	-
26027	Taupe	SEK 3.482,10	-
26022	White	SEK 3.482,10	-
Extras			
24050	Ceiling Cap - White	SEK 116,10	-

26% rabatt ska dras av på angivna priser

AMBIT PENDANT LAMP / Ø 55 CM / 21.7"

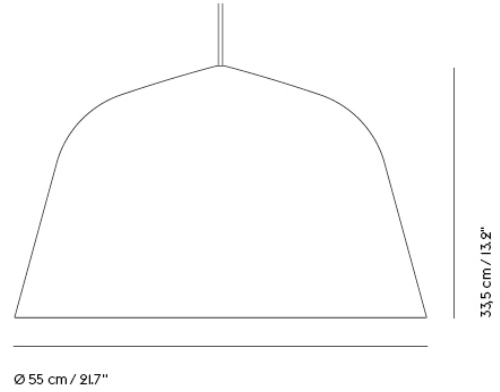

Shipper Colli	1
Gross Weight (kg)	5.585
Net Weight (kg)	2.7
Bulb included	
Warranty Period	5 years

Item No.	Color	Contract Price	Lead Time
Ready-To-Ship			
82270	Black	SEK 5.155,70	-
82274	Dusty Green	SEK 5.155,70	-
82271	Grey	SEK 5.155,70	-
82275	Light Blue	SEK 5.155,70	-
82273	Taupe	SEK 5.155,70	-
82272	White	SEK 5.155,70	-
Extras			
24050	Ceiling Cap - White	SEK 116,10	-

26% rabatt ska dras av på angivna priser

AMBIT RAIL LAMP

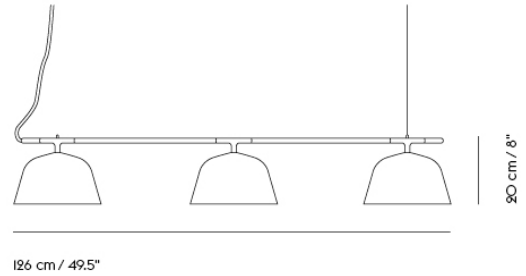

Shipper Colli	1
Gross Weight (kg)	4
Net Weight (kg)	2
Bulb included	
Warranty Period	5 years

Item No.	Color	Contract Price	Lead Time
Ready-To-Ship			
12250	Black	SEK 7.524,10	-
12254	Dusty Green	SEK 7.524,10	-
12251	Grey	SEK 7.524,10	-
12253	Taupe	SEK 7.524,10	-
12252	White	SEK 7.524,10	-
Extras			
15802	Ambit Cord - Dusty Gren (per linear meter)	SEK 59,30	-
15803	Ambit Cord - Grey (per linear meter)	SEK 59,30	-
15806	Ambit Cord - Taupe (per linear meter)	SEK 59,30	-
15804	Fluid / Rime Ø12+Ø18+25 Cord - White (per linear meter)	SEK 59,30	-
15801	Grain / Rime Ø12+Ø18+25 Cord - Black (per linear meter)	SEK 59,30	-

26% rabatt ska dras av på angivna priser

AMBIT WALL LAMP

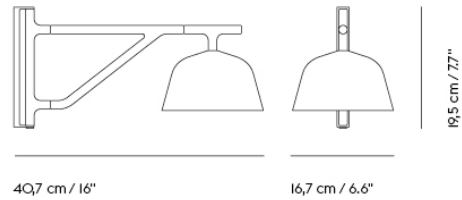

Shipper Colli	1
Gross Weight (kg)	1.734
Net Weight (kg)	1.04
Bulb included	Yes
Warranty Period	5 years

Item No.	Color	Contract Price	Lead Time
Ready-To-Ship			
15311	Black	SEK 3.138,10	-
15313	Grey	SEK 3.138,10	-
15314	Taupe	SEK 3.138,10	-
15312	White	SEK 3.138,10	-
Extras			
15803	Ambit Cord - Grey (per linear meter)	SEK 59,30	-
15806	Ambit Cord - Taupe (per linear meter)	SEK 59,30	-
15804	Fluid / Rime Ø12+Ø18+25 Cord - White (per linear meter)	SEK 59,30	-
15801	Grain / Rime Ø12+Ø18+25 Cord - Black (per linear meter)	SEK 59,30	-

26% rabatt ska dras av på angivna priser

BEAM TABLE LAMP

"The idea for the Beam Table Lamp came while renovating my childhood home. I had made a shelf to use as divider between the hallway and living room and needed a lamp that could at once throw light out into the living room and down the hallway. The Beam Table Lamp mimics a single ray of light that travels through a round tube with its dimmer allowing the user to change the volume of light omitted from both ends of the cylinder shape. Tweak the design to your personal needs through its rotating base and sleek body of anodized aluminum, whether it be as direct lighting or for an ambient glow. With the Beam Table Lamp, you can alter the volume of light omitted, change its direction by the turn of its base and place it on any shelf, table or windowsill for a new perspective on modern lighting."

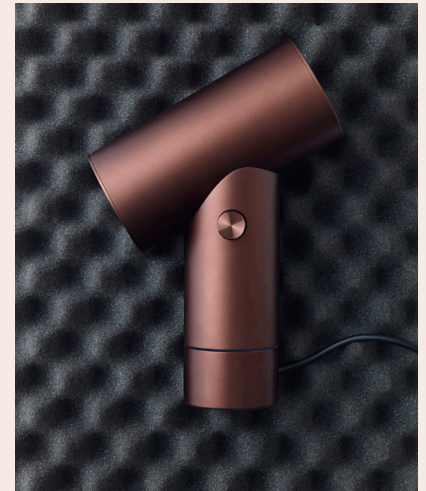

— Tom Chung

Designed by	Tom Chung
Environment	Indoor
Country of Production	China
Cord Length	250 cm / 98.4"
Light Source Included	Yes - integrated LED
Dimmable Function	Yes
Description	The Beam Table Lamp is a versatile table lamp with a modern expression and intuitive user-friendliness. With light shone from both ends of a cylinder shape, the user can choose between three different volumes of light and gradually alter the volume of light emitted in each end through the turn of a playful dial. The Beam Table Lamp can be altered for any position with its rotating base and sleek body of anodized aluminum, whether it be as direct lighting or for an ambient glow in any home, offices, hotel room and educational areas.
Material	Body in anodized aluminum for a matte feel and vibrant look. Cord in PVC. It has a built-in energy efficient LED bulb. The lifetime of the LED bulb is defined as the time it takes until the light output/lumen maintenance reaches 90% (L90) of the initial output. The integrated bulb has a lifespan/lumen maintenance (L90) of 35,000 hours.
Cleaning & Care	Clean with soft dry cloth only. Always switch off electricity supply before cleaning.

26% rabatt ska dras av på angivna priser

BEAM TABLE LAMP

TESTS & CERTIFICATIONS

EU:

IEC 60598-1 and IEC 60598-2-4

Low Voltage Directive (LVD) - 2014/35/EU

ECO Design Directive - 245/2009/EC

ROHS Directive - 2011/65/EU amended RoHS 3 Directive
2015/863

REACH Directive - EC/1907/2006

WEEE Directive - 2012/19/EU

UK:

BS EN 60598-1 and EN 60598-2-4

Electrical Equipment (Safety) Regulations 2016

Electromagnetic Compatibility Regulations 2016

The Restriction of the Use of Certain Hazardous Substances in

Electrical and Electronic Equipment Regulations 2012

The Ecodesign for Energy-Related Products and Energy

Information (Amendment) (EU Exit) Regulations 2019

The Eurasian Economic Union:

TP TC 004 and TP TC 020

USA/Canada:

UL STD. 153 / CSA STD. C22.2 NO.250.4

26% rabatt ska dras av på angivna priser

BEAM TABLE LAMP

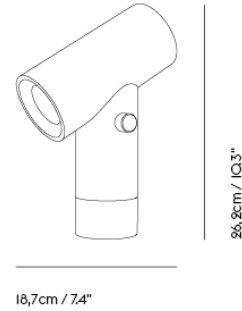

Shipper Colli	1
Gross Weight (kg)	1.72
Net Weight (kg)	1.234
Bulb included	Yes. Integrated non-replaceable LED
Warranty Period	5 years

Item No.	Color	Contract Price	Lead Time
Ready-To-Ship			
12124	Aluminum	SEK 2.536,10	-
12121	Black	SEK 2.536,10	-
12123	Green	SEK 2.536,10	-
12122	Umber	SEK 2.536,10	-

26% rabatt ska dras av på angivna priser

CALM WALL LAMP

"Scandinavian design is partially characterized by its great respect for nature in terms of materials and light; something that I wanted to infuse the Calm Wall Lamp with, creating a light that isn't tamed but instead has an organic flow. This makes for a beautiful gradient between light and shadows that is enhanced by its textile surface for a tactile appearance. The Calm Wall Lamp has a sculptural identity that brings a soft and calming yet powerful presence to any atmosphere."

— Iskos Design

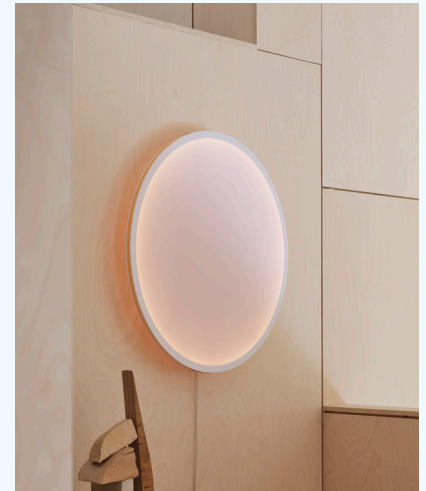

Designed by	Iskos Design
Environment	Indoor
Country of Production	China
Cord Length	250 cm / 98.5"
Light Source Included	Yes
Dimmable Function	Yes
Description	Calm Wall Lamp offers a new perspective on lightning altogether, with a rare blend of atmospheric lighting and sculptural qualities. While it is inherently functional, it is also a work of art in its own right. Its textile surface gently diffuses the light, forming a gradient from its edge to the central light source. The ability to adjust the lighting temperature allows the user to create calm, atmospheric light according to their own preferences and needs. A matte rubber band frames Calm Wall Lamp, lending a crisp edge to the softness of the organic design.
Material	Extruded aluminum profile, steel mounting plates. Injection molded ABS cover, soft diffusing textile shades (front and back). Integrated LED, that is temperature dimmable (dim to warmer lighting). Colored silicone band. Ø50 touch dim comes with a touch button and cable with a plug (no dimmer on the cable. All other sizes/variants come as hard-wired (Wall dim). Cord with inline dimmer and plug can be purchased separately and works for hard-wired versions. Lumen Maintenance: 60.000h. Kelvin: 2200-3000K. CRI >90.
Cleaning & Care	Clean gently with a dry cloth. Fabric shade: Wash cold 30 degrees C or 85 degrees F. Do not bleach. Machine wash gentle or delicate. Flat dry. Do not tumble dry. Do not iron. Always switch off electricity before cleaning.

26% rabatt ska dras av på angivna priser

CALM WALL LAMP

TESTS & CERTIFICATIONS

EU:

REACH Directive - EC/1907/2006

IEC 60598-1 and IEC 60598-2-1

ROHS Directive - 2011/65/EU amended RoHS 3 Directive 2015/863

ECO Design Directive - 245/2009/EC

Electromagnetic Compatibility (EMC) Directive - 2014/30/EU

WEEE Directive - 2012/19/EU

UK:

Electromagnetic Compatibility Regulations 2016

The Restriction of the Use of Certain Hazardous Substances in Electrical and Electronic Equipment Regulations 2012

Australia/New Zealand:

AS/NZS 60598.1 and AS/NZS 60598.2.1

*Does not apply to Ø50 Touch.

The Eurasian Economic Union:

TP TC 004 and TP TC 020

Fire test of textile:

EN 13823:2010+A1:2014 and EN ISO 11925-2:2020

EN 13501-1: B-s1,d0

26% rabatt ska dras av på angivna priser

CALM WALL LAMP / Ø 50 CM / 19.6"

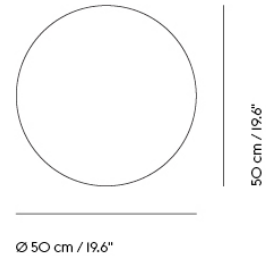
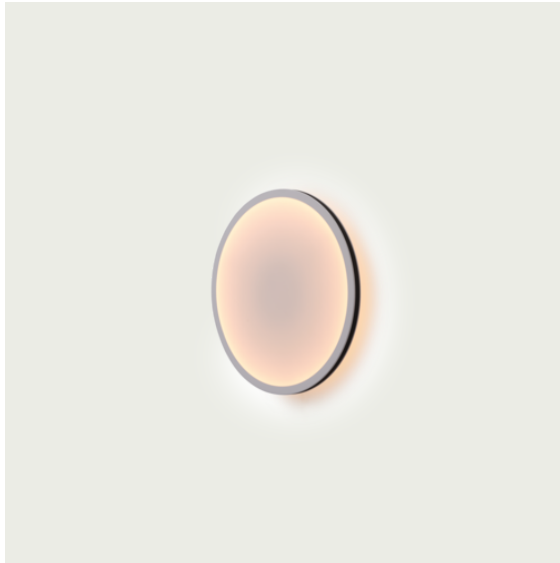

Shipper Colli	2
Gross Weight (kg)	7.543
Net Weight (kg)	4.97
Bulb included	Yes. Integrated, Non-replaceable LED.
Please note	This lamp is hard-wired. A cord with inline dimmer and plug can be purchased separately.
Warranty Period	5 years

Item No.	Color	Contract Price	Lead Time
Ready-To-Ship			
22635	White/Black	SEK 6.922,10	-
22636	White/Grey	SEK 6.922,10	-
22637	White/Orange	SEK 6.922,10	-
Extras			
22690	Extra Silicone Band - Black - Ø 50 CM / 19.6"	SEK 417,10	-
22691	Extra Silicone Band - Grey - Ø 50 CM / 19.6"	SEK 417,10	-
22692	Extra Silicone Band - Orange - Ø 50 CM / 19.6"	SEK 417,10	-
22705	Add-on cord w.inline dim and plug - White - L 250 CM / 98.4"	SEK 571,90	-

26% rabatt ska dras av på angivna priser

CALM WALL LAMP / Ø 50 CM / 19.6" - TOUCH DIM

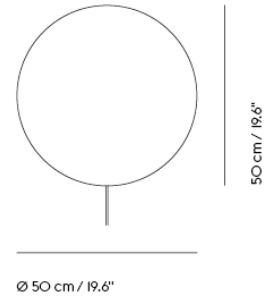
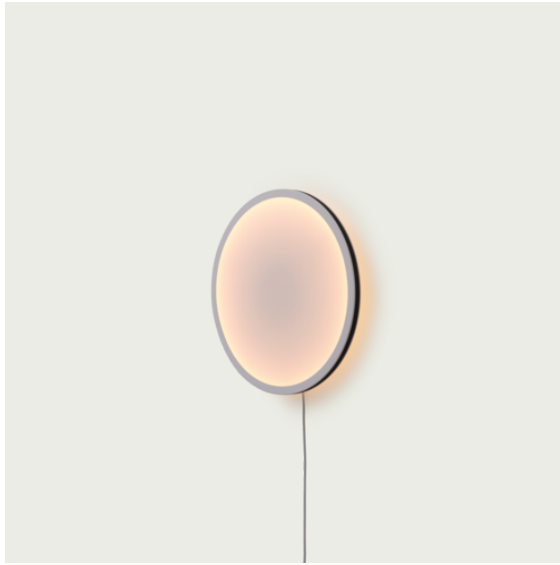

Shipper Colli	2
Gross Weight (kg)	7.793
Net Weight (kg)	4.97
Bulb included	Yes. Integrated, Non-replaceable LED.
Please note	This lamp comes with a touch dim button and a cable with plug.
Warranty Period	5 years

Item No.	Color	Contract Price	Lead Time
Ready-To-Ship			
22620	White/Black	SEK 6.922,10	-
22621	White/Grey	SEK 6.922,10	-
22622	White/Orange	SEK 6.922,10	-
Extras			
22707	Extra Silicone Band - Black - Ø 50 CM / 19.6" - Touch Dim	SEK 417,10	-
22708	Extra Silicone Band - Grey - Ø 50 CM / 19.6" - Touch Dim	SEK 417,10	-
22709	Extra Silicone Band - Orange - Ø 50 CM / 19.6" - Touch Dim	SEK 417,10	-

26% rabatt ska dras av på angivna priser

CALM WALL LAMP / Ø 68 CM / 26.7"

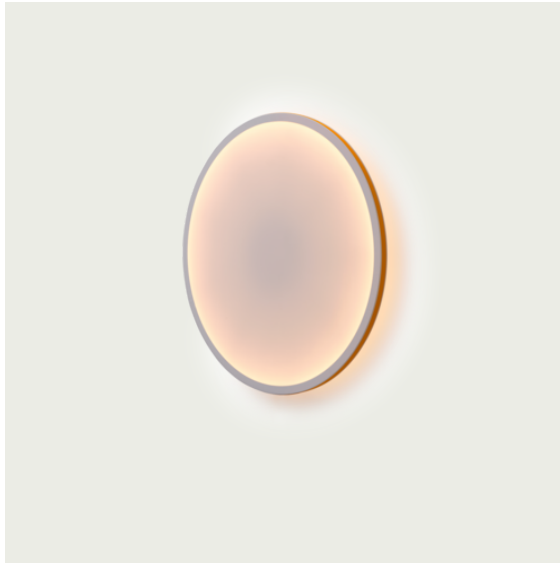

Shipper Colli	2
Gross Weight (kg)	9.893
Net Weight (kg)	6.18
Bulb included	Yes. Integrated, Non-replaceable LED.
Please note	This lamp is hard-wired. A cord with inline dimmer and plug can be purchased separately.
Warranty Period	5 years

Item No.	Color	Contract Price	Lead Time
Ready-To-Ship			
22640	White/Black	SEK 9,455,70	-
22641	White/Grey	SEK 9,455,70	-
22642	White/Orange	SEK 9,455,70	-
Extras			
22695	Extra Silicone Band - Black - Ø 68 CM / 26.7"	SEK 463,50	-
22696	Extra Silicone Band - Grey - Ø 68 CM / 26.7"	SEK 463,50	-
22697	Extra Silicone Band - Orange - Ø 68 CM / 26.7"	SEK 463,50	-
22705	Add-on cord w.inline dim and plug - White - L 250 CM / 98.4"	SEK 571,90	-

26% rabatt ska dras av på angivna priser

CALM WALL LAMP / Ø 90 CM / 35.4"

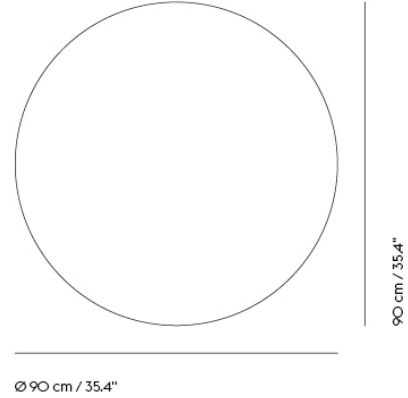
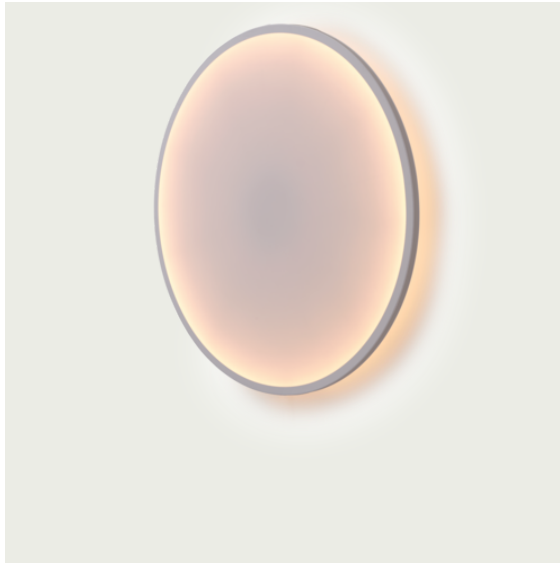

Shipper Colli	2
Gross Weight (kg)	14.82
Net Weight (kg)	8.3
Bulb included	Yes. Integrated, Non-replaceable LED.
Please note	This lamp is hard-wired. A cord with inline dimmer and plug can be purchased separately.
Warranty Period	5 years

Item No.	Color	Contract Price	Lead Time
Ready-To-Ship			
22645	White/Black	SEK 11.605,70	-
22646	White/Grey	SEK 11.605,70	-
22647	White/Orange	SEK 11.605,70	-
Extras			
22705	Add-on cord w.inline dim and plug - White - L 250 CM / 98.4"	SEK 571,90	-
22700	Extra Silicone Band - Black - Ø 90 cm / 35.4"	SEK 580,50	-
22701	Extra Silicone Band - Grey - Ø 90 cm / 35.4"	SEK 580,50	-
22702	Extra Silicone Band - Orange - Ø 90 cm / 35.4"	SEK 580,50	-

26% rabatt ska dras av på angivna priser

CONTROL TABLE LAMP

"The Control Table Lamp is a unique and playful lamp with references to hi-fi and industrial machinery. The light and dimmer is controlled by a switch, referencing volume controls, and is an inviting and simple way of interacting with the user. While designing the lamp, we were inspired by the idea of displaying the different lamp components on a serving plate—almost as a still life. It was a pragmatic approach to making a lamp by the simplest means, a reduced design beyond reduction."

— TAF Studio



Designed by	TAF Studio
Environment	Indoor
Country of Production	China
Cord Length	250 cm / 98.5"
Light Source Included	Yes
Dimmable Function	Yes
Socket Size	E27
Description	The Control Table Lamp places the iconic E27 bulb in a modern context. With the user being able to alter the volume of light emitted according to their preferences through the playful turn of a dial, the Control Table Lamp combines industrial design with Scandinavian values.
Material	The lamp's base is casted in aluminum, polished and finally powder coated. Cord in PVC.
Cleaning & Care	Clean with soft dry cloth only. Always switch off the electricity supply before cleaning.

TESTS & CERTIFICATIONS

EU:

EN 60598-1 and EN 60598-2-4

Low Voltage Directive (LVD) - 2014/35/EU

ECO Design Directive - 245/2009/EC

ROHS Directive - 2011/65/EU amended RoHS 3 Directive 2015/863

REACH Directive - EC/1907/2006

WEEE Directive - 2012/19/EU

UK:

BS EN 60598-1 and EN 60598-2-4

Electrical Equipment (Safety) Regulations 2016

Electromagnetic Compatibility Regulations 2016

The Restriction of the Use of Certain Hazardous Substances in Electrical and Electronic Equipment Regulations 2012

The Ecodesign for Energy-Related Products and Energy Information (Amendment) (EU Exit) Regulations 2019

USA/Canada:

UL STD. 153 / CSA STD. C22.2 NO.250.4

Australia/New Zealand:

AS/NZS 60598.1 and AS/NZS 60598.2.4

*Does not apply to the following colors: Red

26% rabatt ska dras av på angivna priser

CONTROL TABLE LAMP

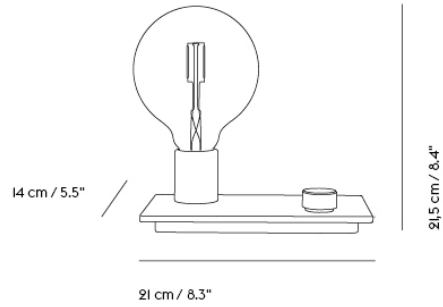

Shipper Colli 1
 Gross Weight (kg) 1.4055
 Net Weight (kg) 0.9125
 Bulb included Yes
 Warranty Period 5 years

Item No.	Color	Contract Price	Lead Time
Ready-To-Ship			
15410	Black	SEK 1.504,10	-
15412	Grey	SEK 1.504,10	-
15413	Red	SEK 1.504,10	-
15411	White	SEK 1.504,10	-

26% rabatt ska dras av på angivna priser

COSY IN GREY TABLE LAMP

"The idea for the Cosy In Grey was to create a lamp that created a spatial atmosphere within the room. I put my trust in the natural material of glass; its beauty and changing reflections. The Cosy In Grey Table Lamp expresses the beauty of electrical light in a modern form. Whether it be early mornings, during lunch or a cold night, the Cosy In Grey Table Lamp will bring a warm and friendly atmosphere to any space."

— Harri Koskinen

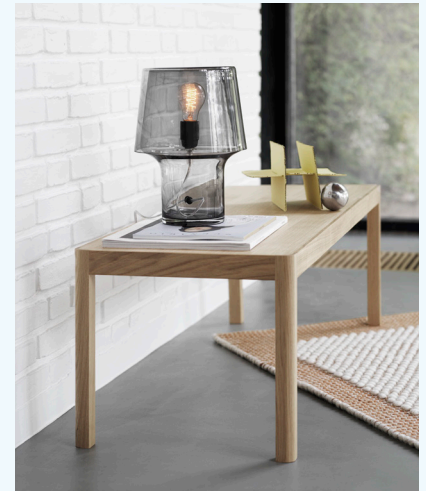

Designed by	Harri Koskinen
Environment	Indoor
Country of Production	China
Cord Length	260 cm / 102.25"
Light Source Included	No. Only use dimmable bulb.
Dimmable Function	Yes
Socket Size	E27
Description	With its modern shape in mouth-blown glass, the Cosy In Grey Table Lamp provides gentle lighting through its dimmable naked bulb, encased in smoked grey glass. Place the Cosy In Grey Table Lamp in any space for a new perspective on ambient lighting.
Material	The Cosy in Grey Table Lamp is handmade, mouth blown in colored soda lime glass, cut grinded and polished by hand. PVC cord with a dimmer, plastic socket and an internal clear plastic construction to secure cord and socket. Bulb not included.
Cleaning & Care	Clean with soft dry cloth only. Always switch off the electricity supply before cleaning.

TESTS & CERTIFICATIONS

EU:

EN 60598-1 and EN 60598-2-4

Low Voltage Directive (LVD) - 2014/35/EU

ECO Design Directive - 245/2009/EC

ROHS Directive - 2011/65/EU amended RoHS 3 Directive 2015/863

REACH Directive - EC/1907/2006

WEEE Directive - 2012/19/EU

UK:

BS EN 60598-1 and EN 60598-2-4

Electrical Equipment (Safety) Regulations 2016

Electromagnetic Compatibility Regulations 2016

The Restriction of the Use of Certain Hazardous Substances in Electrical and Electronic Equipment Regulations 2012

The Ecodesign for Energy-Related Products and Energy Information (Amendment) (EU Exit) Regulations 2019

26% rabatt ska dras av på angivna priser

COSY IN GREY TABLE LAMP

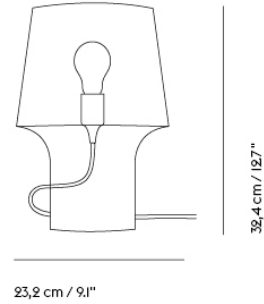

Shipper Colli 1
Gross Weight (kg) 4.3
Net Weight (kg) 3.4
Bulb included
Warranty Period 5 years

Item No.	Color	Contract Price	Lead Time
Ready-To-Ship			
01033	Grey	SEK 2.317,70	-

26% rabatt ska dras av på angivna priser

DEDICATE LAMP SERIES

“From a design perspective, the Dedicate Lamp is a harmonious exploration of an iconic form, ingeniously enhancing its functionality while maintaining a strong connection to its original concept. This transformation pays homage to its predecessor, seamlessly melding tradition with innovation.”

— Thomas Bentzen



Designed by	Thomas Bentzen
Environment	Indoor
Country of Production	China
Cord Length	250 cm / 98.4"
Light Source Included	Yes - integrated LED
Dimmable Function	Yes
Description	The Dedicate Table Lamp is a contemporary take on the classic architect lamp, where design meets functionality seamlessly. Meticulously engineered, the lamp offers integrated cooling ribs, quality lighting, dimming, and an auto-turn-off feature — while guaranteeing steadiness through its flexible arms. Available in various sizes, the Dedicate Table Lamp caters to diverse lighting needs and design preferences, providing a versatile lighting solution.
Material	The lamp head and hinges are in die-casted aluminum, and the lamp arms are in extruded aluminum. All powder coated. Diffuser in injection molded plastic. Table base in machined steel. Clamp in die-casted aluminum and screw in stainless steel—pin in machined steel screw and fixing nut. Integrated dimmable LED light source. Lumen: 750lm on 100% brightness. Lumen Maintenance (80%) : 35.000h. Kelvin: 3000K. CRI >90. The lamp comes with a built-in 8-hour timer.
Cleaning & Care	Clean the Dedicate Lamp with a soft, dry cloth only. Always switch off the electricity supply before cleaning.

26% rabatt ska dras av på angivna priser

DEDICATE LAMP SERIES

TESTS & CERTIFICATIONS

EU:

IEC 60598-1 and IEC 60598-2-4

Low Voltage Directive (LVD) - 2014/35/EU

ECO Design Directive - 245/2009/EC

Electromagnetic Compatibility (EMC) Directive - 2014/30/EU

ROHS Directive - 2011/65/EU amended RoHS 3 Directive 2015/863

REACH Directive - EC/1907/2006

WEEE Directive - 2012/19/EU

UK:

BS EN 60598-1 and EN 60598-2-4

Electrical Equipment (Safety) Regulations 2016

Electromagnetic Compatibility Regulations 2016

The Restriction of the Use of Certain Hazardous Substances in Electrical and Electronic Equipment Regulations 2012

The Ecodesign for Energy-Related Products and Energy Information (Amendment) (EU Exit) Regulations 2019

USA/Canada:

UL STD. 153 / CSA STD. C22.2 NO.250.4

Australia/New Zealand:

AS/NZS 60598.1 and AS/NZS 60598.2.4

26% rabatt ska dras av på angivna priser

DEDICATE TABLE LAMP / SI

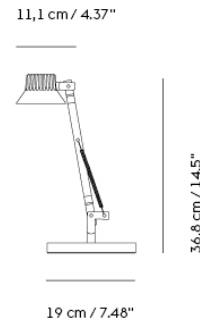

Shipper Colli	2
Gross Weight (kg)	5.26
Net Weight (kg)	4.41
Warranty period	5 years

Item No.	Color	Contract Price	Lead Time
Ready-To-Ship			
14379	Black	SEK 4.037,70	-
14391	Brown Green	SEK 4.037,70	-

26% rabatt ska dras av på angivna priser

DEDICATE TABLE LAMP / S2



38,9 cm / 15.31"

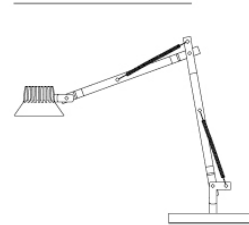

39,8 cm / 15.7"

19 cm / 7.48"

Shipper Colli	2
Gross Weight (kg)	5.59
Net Weight (kg)	4.52
Warranty period	5 years

Item No.	Color	Contract Price	Lead Time
Ready-To-Ship			
14380	Black	SEK 4.295,70	-
14392	Brown Green	SEK 4.295,70	-

26% rabatt ska dras av på angivna priser

DEDICATE TABLE LAMP / L2



50,6 cm / 19.92"

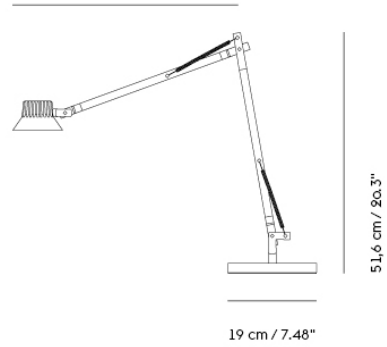

Shipper Colli	2
Gross Weight (kg)	5.74
Net Weight (kg)	4.555
Warranty period	5 years

Item No.	Color	Contract Price	Lead Time
Ready-To-Ship			
14381	Black	SEK 4.295,70	-
14393	Brown Green	SEK 4.295,70	-

26% rabatt ska dras av på angivna priser

DEDICATE TABLE LAMP / W. CLAMP - SI

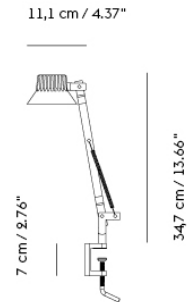

Shipper Colli	2
Gross Weight (kg)	0.885
Net Weight (kg)	0.605
Warranty period	5 years

Item No.	Color	Contract Price	Lead Time
Ready-To-Ship			
14382	Black	SEK 3.263,70	-
14394	Brown Green	SEK 3.263,70	-

26% rabatt ska dras av på angivna priser

DEDICATE TABLE LAMP / W. CLAMP - S2

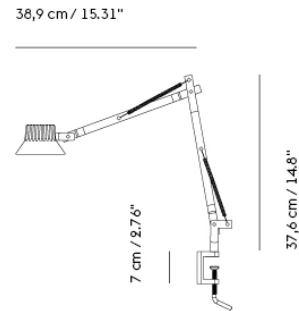
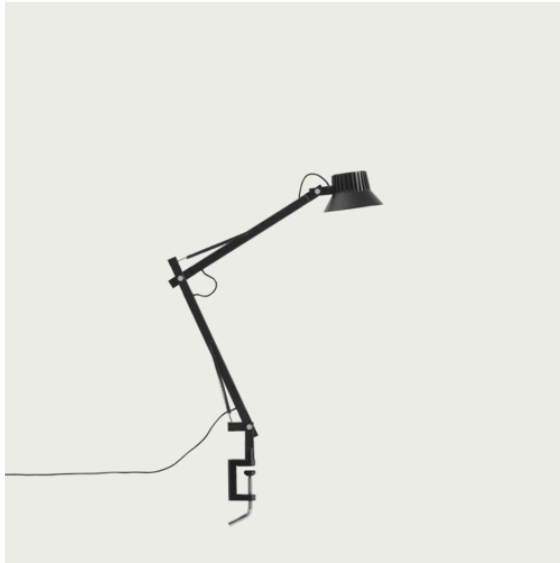

Shipper Colli 2
Gross Weight (kg) 1.215
Net Weight (kg) 0.715
Warranty period 5 years

Item No.	Color	Contract Price	Lead Time
Ready-To-Ship			
14383	Black	SEK 3.482,10	-
14395	Brown Green	SEK 3.482,10	-

26% rabatt ska dras av på angivna priser

DEDICATE TABLE LAMP / W. CLAMP - L2

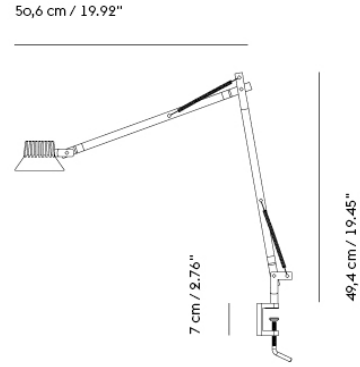

Shipper Colli 2
 Gross Weight (kg) 1.365
 Net Weight (kg) 0.75
 Warranty period 5 years

Item No.	Color	Contract Price	Lead Time
Ready-To-Ship			
14384	Black	SEK 3.482,10	-
14396	Brown Green	SEK 3.482,10	-

26% rabatt ska dras av på angivna priser

DEDICATE TABLE LAMP / W. PIN - SI



11,1 cm / 4.37"

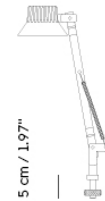

5 cm / 1.97"

34,7 cm / 13.66"

Shipper Colli	2
Gross Weight (kg)	0.76407
Net Weight (kg)	0.58
Warranty period	5 years

Item No.	Color	Contract Price	Lead Time
Ready-To-Ship			
14385	Black	SEK 3.263,70	-
14397	Brown Green	SEK 3.263,70	-

26% rabatt ska dras av på angivna priser

DEDICATE TABLE LAMP / W. PIN - S2

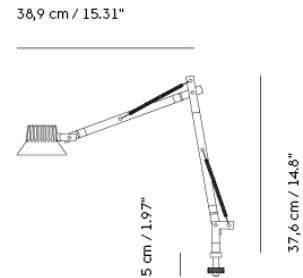

Shipper Colli 2
Gross Weight (kg) 1.235
Net Weight (kg) 0.69
Warranty period 5 years

Item No.	Color	Contract Price	Lead Time
Ready-To-Ship			
14386	Black	SEK 3.482,10	-
14398	Brown Green	SEK 3.482,10	-

26% rabatt ska dras av på angivna priser

DEDICATE TABLE LAMP / W. PIN - L2



50,6 cm / 19.92"

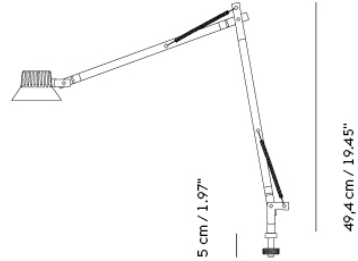

Shipper Colli	2
Gross Weight (kg)	1.385
Net Weight (kg)	0.725
Warranty period	5 years

Item No.	Color	Contract Price	Lead Time
Ready-To-Ship			
14387	Black	SEK 3.482,10	-
14399	Brown Green	SEK 3.482,10	-

26% rabatt ska dras av på angivna priser

DEDICATE WALL LAMP / SI

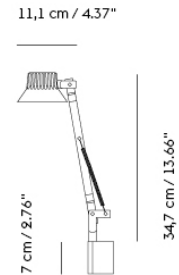

Shipper Colli 2
Gross Weight (kg) 0.84
Net Weight (kg) 0.56
Warranty period 5 years

Item No.	Color	Contract Price	Lead Time
Ready-To-Ship			
14388	Black	SEK 3.263,70	-
14400	Brown Green	SEK 3.263,70	-

26% rabatt ska dras av på angivna priser

DEDICATE WALL LAMP / S2



38,9 cm / 15.31"

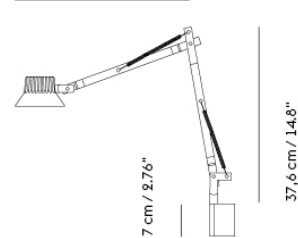

Shipper Colli	2
Gross Weight (kg)	1.17
Net Weight (kg)	0.67
Warranty period	5 years

Item No.	Color	Contract Price	Lead Time
Ready-To-Ship			
14389	Black	SEK 3.482,10	-
14401	Brown Green	SEK 3.482,10	-

26% rabatt ska dras av på angivna priser

DEDICATE WALL LAMP / L2

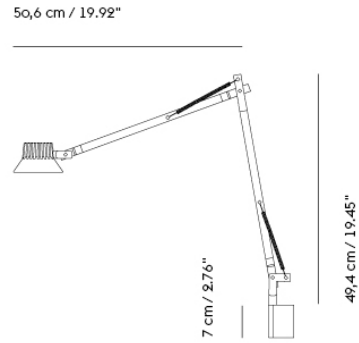

Shipper Colli 2
Gross Weight (kg) 1.32
Net Weight (kg) 0.705
Warranty period 5 years

Item No.	Color	Contract Price	Lead Time
Ready-To-Ship			
14390	Black	SEK 3.482,10	-
14402	Brown Green	SEK 3.482,10	-

26% rabatt ska dras av på angivna priser

E27 PENDANT LAMP

"The simplicity of the naked bulb is hard to compete with. It stands for something that feels romantic and contemporary at the same time. The E27 Pendant Lamp departs from the essence of a lamp—the socket—creating a simple yet strong object that celebrates the potential beauty in simplicity."

— Mattias Ståhlbom



Designed by	Mathias Ståhlbom
Environment	Indoor
Country of Production	China
Cord Length	400 cm / 157.5"
Light Source Included	Yes
Dimmable Function	Yes
Socket Size	E27
Description	The E27 Pendant Lamp joins together the ideas of industrial design and Scandinavian simplicity. With its naked LED bulb and sleek in a playful silicone rubber material, the design makes for a simple yet distinctive addition to any space. Use the E27 Pendant Lamp on its own or in clusters for any space of a home, workplace, restaurant, educational institution or retail space.
Material	The E27 Pendant Lamp is pressed in vulcanised silicone rubber under high temperature. The inside plastic socket and PVC cord is assembled by hand.
Cleaning & Care	Clean with soft dry cloth only. Always switch off the electricity supply before cleaning.

26% rabatt ska dras av på angivna priser

E27 PENDANT LAMP

TESTS & CERTIFICATIONS

EU:

IEC 60598-1 and IEC 60598-2-1

Low Voltage Directive (LVD) - 2014/35/EU

ECO Design Directive - 245/2009/EC

ROHS Directive - 2011/65/EU amended RoHS 3 Directive 2015/863

REACH Directive - EC/1907/2006

WEEE Directive - 2012/19/EU

UK:

BS EN 60598-1 and BS 4533-102.1, EN 60598-2-1

Electrical Equipment (Safety) Regulations 2016

Electromagnetic Compatibility Regulations 2016

The Restriction of the Use of Certain Hazardous Substances in Electrical and Electronic Equipment Regulations 2012

The Ecodesign for Energy-Related Products and Energy Information (Amendment) (EU Exit) Regulations 2019

USA/Canada:

UL STD. 1598 / CSA STD. C22.2 NO.250.0

Australia/New Zealand:

AS/NZS 60598.1 and AS/NZS 60598.2.1

The Eurasian Economic Union:

TP TC 004 and TP TC 020

China:

GB 7000.201 and GB 7000.1

*Does not apply to the following colors: Beige-Green, Burgundy, Clay Brown

26% rabatt ska dras av på angivna priser

E27 PENDANT LAMP

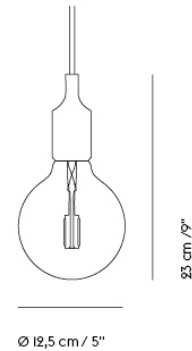

Shipper Colli	1
Gross Weight (kg)	0.7
Net Weight (kg)	0.3
Bulb included	Yes
Warranty Period	5 years

Item No.	Color	Contract Price	Lead Time
Ready-To-Ship			
13355	Beige-Green	SEK 752,50	-
13345	Black	SEK 752,50	-
05291	Burgundy ***	SEK 752,50	-
13330	Dark Green	SEK 752,50	-
13340	Dark Grey ***	SEK 752,50	-
13334	Deep Red	SEK 752,50	-
13333	Dusty Lilac	SEK 752,50	-
13331	Light Blue	SEK 752,50	-
13347	Light Green	SEK 752,50	-
13348	Light Grey	SEK 752,50	-
13335	Light Orange	SEK 752,50	-
13332	Midnight Blue	SEK 752,50	-
13350	Mustard ***	SEK 752,50	-
13353	Olive	SEK 752,50	-
13356	Pale Blue	SEK 752,50	-
13341	White	SEK 752,50	-
Extras			
12270	E27 Cord - Dark Green (per linear meter)	SEK 26,00	-
12278	E27 Cord - Deep Red (per linear meter)	SEK 26,00	-
12277	E27 Cord - Dusty Lilac (per linear meter)	SEK 26,00	-
12275	E27 Cord - Light Blue (per linear meter)	SEK 26,00	-

26% rabatt ska dras av på angivna priser

Item No.	Color	Contract Price	Lead Time
12287	E27 Cord - Light Green (per linear meter)	SEK 26,00	-
12279	E27 Cord - Light Orange (per linear meter)	SEK 26,00	-
12276	E27 Cord - Midnight Blue (per linear meter)	SEK 26,00	-
12296	E27 Cord - Pale Blue (per linear meter)	SEK 26,00	-
12285	Unfold / E27 Cord - Black (per linear meter)	SEK 26,00	-
12297	Unfold / E27 Cord - Burgundy (per linear meter) ***	SEK 26,00	-
12280	Unfold / E27 Cord - Dark Grey (per linear meter)	SEK 26,00	-
12288	Unfold / E27 Cord - Light Grey (per linear meter)	SEK 26,00	-
12290	Unfold / E27 Cord - Mustard (per linear meter)	SEK 26,00	-
12293	Unfold / E27 Cord - Olive (per linear meter)	SEK 26,00	-
12281	Unfold / E27 Cord - White (per linear meter)	SEK 26,00	-
24050	Ceiling Cap - White	SEK 116,10	-

26% rabatt ska dras av på angivna priser

EASE PORTABLE LAMP

"I wanted the Ease Portable Lamp to have a remarkable quality of light, striking a versatile balance between atmospheric and functional light — after all, that is the wonderful thing about a portable lamp — you can bring a distinct ambience to literally anywhere. I landed on the idea of the top and bottom gently touching, softly meeting each other. There is a sense of lightness to it. This feature allows a large surface to emit light, while the flared bottom firmly stabilizes it. It is these details that give the lamp a sort of human quality, making it a reliable friend."

— Johan van Hengel



Design by	Johan van Hengel
Environment	Indoor / Outdoor
Country of Production	China
Cord Length	90 cm / 35.4" USB wire incl. charging dock (no power adapter included)
Light Source Included	Yes - Integrated, non replaceable LED
Dimmable Function	Yes - Three step dimming
Description	Inspired by shapes of traditional table lamps, the Ease Portable Lamp transforms this typology into a carryable size, suitable to take wherever. Ease offers a high-quality dimmable, no-glare light with three levels, striking a balance between atmospheric and functional light. The design has a distinct lightness to it, with the top and bottom gently touching. A slightly flared bottom mimics the lip of a vase in a grounding gesture that allows the base to be slimmer and easier to grab. Ease Portable Lamp is a humble friend with a strong character that works alone or in repetition in any setting; from the bedside, reading nook and home office to the restaurant or café table, co-working space or library.
Material	Battery-powered, dimmable and portable lamp with 8 hours of battery life on 100% intensity, 16 hours on 50% intensity and 29 hours on 25% intensity. Body and lampshade made in injection-molded ABS plastic, with an integrated LED light source. Diffuser in opal acrylic. Charging dock made in injection-molded ABS plastic with USB-C cable. Lumen Maintenance (L70): 52.000h. Lumen: 230lm on 100% brightness. Kelvin: 2700K. CRI >90. The Ease Portable lamp is suitable for outdoor use with an IP54 rating. The lamp is protected and tested against solid foreign objects, such as dust ingress, as well as liquids, such as water splashes, from all angles.
Cleaning & Care	Clean with a moist cloth. If necessary, use a little dish soap on the cloth.

TESTS & CERTIFICATIONS

EU:

IEC 60598-1 and IEC 60598-2-1

Low Voltage Directive (LVD) - 2014/35/EU

ECO Design Directive - 245/2009/EC

ROHS Directive - 2011/65/EU amended RoHS 3 Directive 2015/863

REACH Directive - EC/1907/2006

WEEE Directive - 2012/19/EU

Electromagnetic Compatibility (EMC) Directive - 2014/30/EU

UK:

BS EN 60598-1 and BS 4533-102.1, EN 60598-2-1

Electrical Equipment (Safety) Regulations 2016

Electromagnetic Compatibility Regulations 2016

The Restriction of the Use of Certain Hazardous Substances in Electrical and Electronic Equipment Regulations 2012

The Ecodesign for Energy-Related Products and Energy Information (Amendment) (EU Exit) Regulations 2019

Australia/New Zealand:

AS/NZS 60598.1 and AS/NZS 60598.2.4

26% rabatt ska dras av på angivna priser

EASE PORTABLE LAMP



13,16 cm / 5.18"

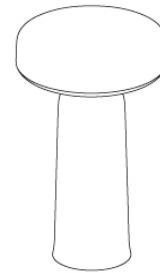

21,5 cm / 8.46"

Shipper Colli	1
Gross Weight (kg)	1
Net Weight (kg)	0.6
Bulb included	Yes. Integrated, dimmable, non-replaceable LED module.
Warranty Period	5 years

Item No.	Color	Contract Price	Lead Time
Ready-To-Ship			
22740	Black	SEK 1.762,10	-
22741	Grey	SEK 1.762,10	-
22743	Light Blue	SEK 1.762,10	-
22742	Taupe	SEK 1.762,10	-
Extras			
22746	Ease Portable Lamp Dock - Black	SEK 214,10	-
22744	Portable Charging Station - Black	SEK 5.804,10	-

26% rabatt ska dras av på angivna priser

PORTABLE CHARGING STATION

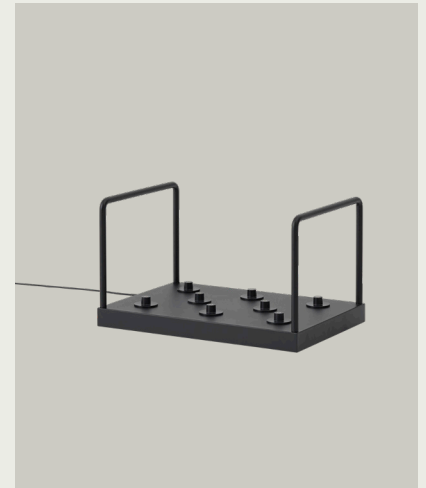

Environment	Indoor
Country of Production	China
Assembly Required	Yes. Only need to be mounted if needed.
Cord Length	30 cm / 11.81"
Description	A charging tray unit allows one to charge 8 portable Ease Portable Lamps at the same time. The system is scalable, as it allows one to stack trays, and the unit is easily made mobile by placing it on top a standard Euro container Dolly or trolley. This makes it a solution that fits the needs and requirements of a broad customer range; from small cafés and restaurants to large conference centers and hotels. The charging station is easy to assemble and comes flat packed.
Materials	Sheet metal, aluminum handles, ABS Charging docks.
Cleaning & Care	Clean with a moist cloth. Always disconnect from electricity before cleaning.
Additional information	Scalable system that allows up to 3 charging trays to be stacked on top of each other. Dimensions on the charging tray is compatible to a standard Euro container Dolly or trolley. A dolly or trolley is not offered by Muuto. Height on tray incl. charging dock: 8 cm / 3.1"

TESTS & CERTIFICATIONS

EU:

Low Voltage Directive (LVD) - 2014/35/EU
ECO Design Directive - 245/2009/EC
ROHS Directive - 2011/65/EU amended RoHS 3 Directive 2015/863
REACH Directive - EC/1907/2006
WEEE Directive - 2012/19/EU
Electromagnetic Compatibility (EMC) Directive - 2014/30/EU

UK:

Electrical Equipment (Safety) Regulations 2016 - IEC 6035-1 and IEC 60335-2
Electromagnetic Compatibility Regulations 2016
The Restriction of the Use of Certain Hazardous Substances in Electrical and Electronic Equipment Regulations 2012
The Ecodesign for Energy-Related Products and Energy Information (Amendment) (EU Exit) Regulations 2019

26% rabatt ska dras av på angivna priser

PORTABLE LAMP CHARGING STATION

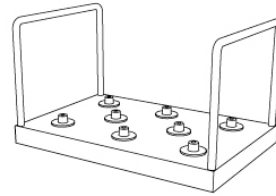
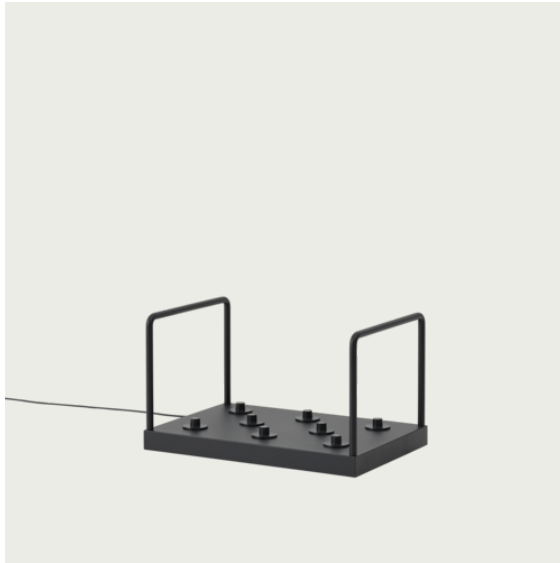

W 40 cm / 15.75"
H 35 cm / 13.78"

L 60 cm / 23.62"

Shipper Colli	1
Gross Weight (kg)	9.2
Net Weight (kg)	7.7
Please note	A maximum of 3 trays can be stacked on top of one another.
Warranty Period	5 years

Item No.	Color	Contract Price	Lead Time
Ready-To-Ship			
22744	Portable Charging Station - Black	SEK 5.804,10	-

26% rabatt ska dras av på angivna priser

FLUID PENDANT LAMP

"We wanted to give the lamp a form with a certain softness, towards a more natural language and further removed from pure geometry. Fascinated by the way that surface tension governs the curvature of a resting water droplet, we have tried to capture its essence. The subtle irregularity of the Fluid Pendant Lamp means that their silhouette gently changes depending upon the viewing angle. It also brings a greater light intensity to the lamp's underside—just where you need it."

— Claesson Kovisto Rune



Designed by	Claesson Kovisto Rune
Environment	Indoor
Country of Production	China
Cord Length	350 cm / 137.75"
Light Source Included	Ø42: No / Ø23: Yes
Dimmable Function	Ø42: Yes / Ø23: No
Socket Size	Ø42: E27 / Ø23: G9
Ceiling Cap Included	Yes
Description	Inspired by a resting drop of water, the Fluid Pendant Lamp shows how soft light can diffuse across a space for a cosy atmosphere. The frosted matte surface creates a glowing ambience that fits into any home or casual business setting. Present the design individually or in a group for an intimate atmosphere.
Material	White silk matte opal glass, lid in Nylon 66 with fibre glass.
Cleaning & Care	Clean with soft dry cloth only. Always switch off the electricity supply before cleaning.

TESTS & CERTIFICATIONS

EU:

IEC 60598-1 and IEC 60598-2-1
Low Voltage Directive (LVD) - 2014/35/EU
ECO Design Directive - 245/2009/EC
ROHS Directive - 2011/65/EU amended RoHS 3 Directive 2015/863
REACH Directive - EC/1907/2006
WEEE Directive - 2012/19/EU

UK:

BS EN 60598-1 and BS 4533-102.1, EN 60598-2-1
Electrical Equipment (Safety) Regulations 2016
Electromagnetic Compatibility Regulations 2016
The Restriction of the Use of Certain Hazardous Substances in Electrical and Electronic Equipment Regulations 2012
The Ecodesign for Energy-Related Products and Energy Information (Amendment) (EU Exit) Regulations 2019

USA/Canada:

UL STD. 1598 / CSA STD. C22.2 NO.250.0

Australia/New Zealand:

AS/NZS 60598.1 and AS/NZS 60598.2.1

China:

GB 7000.201 and GB 7000.1

26% rabatt ska dras av på angivna priser

FLUID PENDANT LAMP / LARGE

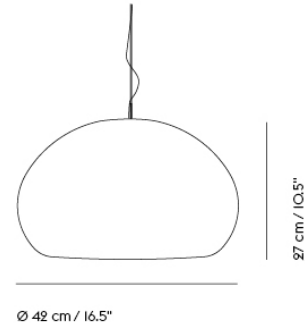

Shipper Colli	1
Gross Weight (kg)	4.95
Net Weight (kg)	3.1
Bulb included	
Warranty Period	5 years

Item No.	Color	Contract Price	Lead Time
Ready-To-Ship			
15401	Opal White	SEK 3.349,70	-
Extras			
15804	Fluid / Rime Ø12+Ø18+25 Cord - White (per linear meter)	SEK 59,30	-
24052	Ceiling Cap for wire suspension lamps - White	SEK 262,30	-

26% rabatt ska dras av på angivna priser

FLUID PENDANT LAMP / SMALL

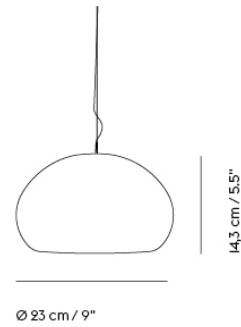
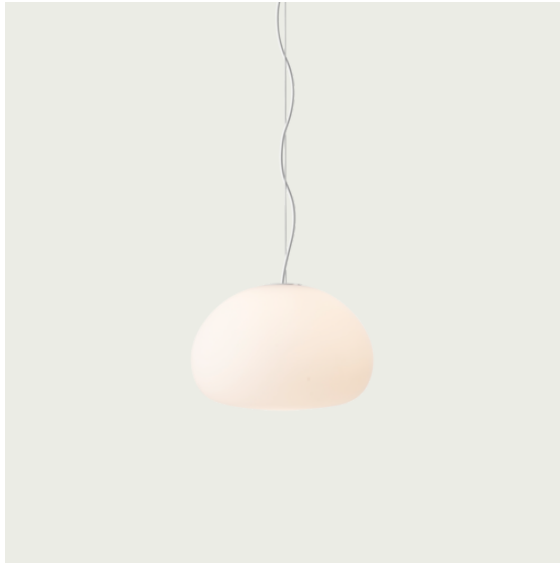

Shipper Colli	1
Gross Weight (kg)	1.55
Net Weight (kg)	0.85
Bulb included	Yes
Warranty Period	5 years

Item No.	Color	Contract Price	Lead Time
Ready-To-Ship			
15400	Opal White - Small	SEK 1.848,10	-
Extras			
15804	Fluid / Rime Ø12+Ø18+25 Cord - White (per linear meter)	SEK 59,30	-
24052	Ceiling Cap for wire suspension lamps - White	SEK 262,30	-

26% rabatt ska dras av på angivna priser

FOCUS TABLE LAMP

"The Focus Table Lamp is an everyday object with a sculptural appeal and an apparent function: it is a lamp and a pedestal where your favorite small objects may be placed and highlighted. Working with the appearance and the delicate dimensions, I tried to give the lamp a unique personality characterized by an embracing and protective nature. The focus is on the pedestal and the object which is placed on it. Therefore, all components are fixed in position. Personally, the pedestal, with a cone of ambient light, solved my problem of misplacing my keys. Now I always know where they are."

— Andreas Bergsaker



Designed by	Andreas Bergsaker
Environment	Indoor
Country of Production	China
Light Source Included	Yes
Dimmable Function	No
Socket Size	GU10
Description	Scandinavian in its expression, the Focus Table Lamp highlights its ash wood body with black paint that allows for the texture of the wood to shine through. With a protruding base that is perfect for small items, the lamp fits seamlessly on a windowsill or shelf in need a bit of light.
Material	Focus Lamp's wooden components are shaped on a lathe machine. The electrical parts are hidden inside the lamps components, which are glued together to hide that they were ever apart. Thereafter, the lamp is painted. Ash wood and PVC cord.
Cleaning & Care	Clean with soft dry cloth only. Always switch off the electricity supply before cleaning.

TESTS & CERTIFICATIONS

EU:

EN 60598-1 and EN 60598-2-4

Low Voltage Directive (LVD) - 2014/35/EU

ECO Design Directive - 245/2009/EC

ROHS Directive - 2011/65/EU amended RoHS 3 Directive 2015/863

REACH Directive - EC/1907/2006

WEEE Directive - 2012/19/EU

UK:

BS EN 60598-1 and EN 60598-2-4

Electrical Equipment (Safety) Regulations 2016

Electromagnetic Compatibility Regulations 2016

The Restriction of the Use of Certain Hazardous Substances in Electrical and Electronic Equipment Regulations 2012

The Ecodesign for Energy-Related Products and Energy Information (Amendment) (EU Exit) Regulations 2019

26% rabatt ska dras av på angivna priser

FOCUS TABLE LAMP

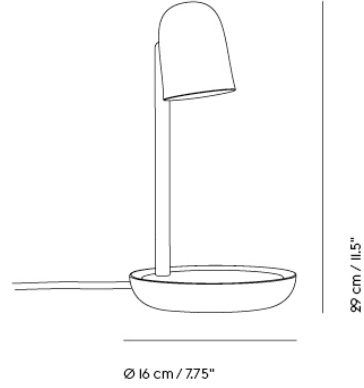

Shipper Colli	1
Gross Weight (kg)	1.05
Net Weight (kg)	0.695
Bulb included	Yes. Integrated LED.
Warranty Period	5 years

Item No.	Color	Contract Price	Lead Time
Ready-To-Ship			
21952	Black	SEK 1.332,10	-

26% rabatt ska dras av på angivna priser

FINE SUSPENSION LAMP

“Fine Suspension Lamp is a minimal design refined to include only the essential; a slim light, a form-pressed fixture with aluminum end caps, a cord. We wanted it to feel delicate, almost jewelry-like — a sleek band of white light. It is a simple, raw expression of clarity and directness with an industrial character. Possible to hang both horizontally and vertically, we designed it so that the lamp’s light source is laid bare, yet gives a no-glare, comfortable light.”

— TAF Studio



Designed by	TAF Studio
Environment	Indoor
Country of Production	China
Cord Length	400 cm / 157.5"
Light Source Included	Yes - integrated LED
Dimmable Function	Yes
Description	Fine Suspension Lamp is a take on a classic tube light combining industrial minimalism with refined detailing for a truly elegant expression. A uniquely versatile piece, it offers a myriad of options, available in three sizes that can be hung both horizontally and vertically, and as an ambient, general or task light with a 320 degree beam angle. These qualities make it a design with many faces; as understated lighting enhancing the space or a statement piece whether hung alone and in clusters.
Material	Body in pressure-die casted and extruded, powder coated aluminum. Diffuser in extruded opaque plastic. Lamp driver integrated in white plastic canopy. Dimmable, integrated and replaceable LED light designed for Right to Repair, meaning that light source can be replaced by an electrician only. Lumen maintenance: 35.000h. Kelvin: 2700K. CRI: >90.
Cleaning & Care	Clean with moist cloth. Always switch off electricity supply before cleaning.
Additional Product Information	Please note that the main wire connecting to the electrical outlet is not included, and it is the responsibility of the end user to make arrangements for installation. We recommend that any tasks related to high-voltage systems only be performed by a licensed electrical contractor.

TESTS & CERTIFICATIONS

EU:

IEC 60598-1 and IEC 60598-2-1

Low Voltage Directive (LVD) - 2014/35/EU

REACH Directive - EC/1907/2006

ROHS Directive - 2011/65/EU amended RoHS 3 Directive 2015/863

WEEE Directive - 2012/19/EU

UK:

BS EN 60598-1 and BS 4533-102.1, EN 60598-2-1

The Restriction of the Use of Certain Hazardous Substances in Electrical and Electronic Equipment Regulations 2012

The Eurasian Economic Union:

TP TC 004 and TP TC 020

26% rabatt ska dras av på angivna priser

FINE SUSPENSION LAMP / 60 CM / 23.5"

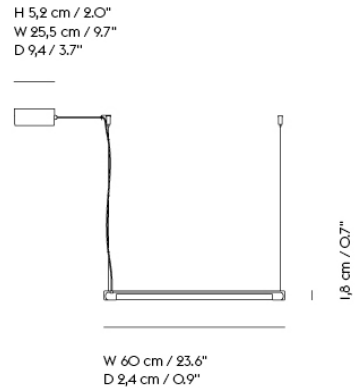

Shipper Colli	1
Gross Weight (kg)	1.08
Net Weight (kg)	0.65
Bulb included	Yes. Integrated LED.
Warranty Period	5 years

Item No.	Color	Contract Price	Lead Time
Ready-To-Ship			
22750	Black	SEK 3.482,10	-
22752	Deep Red	SEK 3.482,10	-
22751	Grey	SEK 3.482,10	-

26% rabatt ska dras av på angivna priser

FINE SUSPENSION LAMP / 90 CM / 35.5"

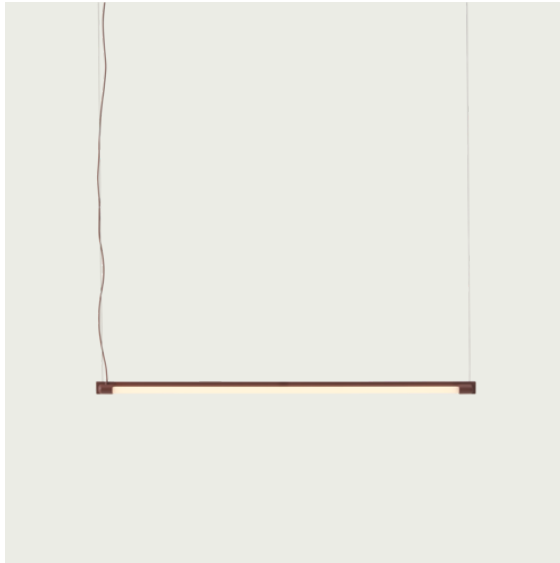

H 5,2 cm / 2,0"
W 25,5 cm / 9,7"
D 9,4 / 3,7"

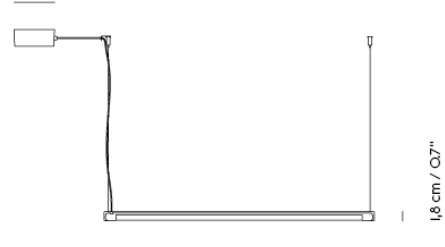

W 90 cm / 35,4"
D 2,4 cm / 0,9"

Shipper Colli	1
Gross Weight (kg)	1.46
Net Weight (kg)	0.75
Bulb included	Yes. Integrated LED.
Warranty Period	5 years

Item No.	Color	Contract Price	Lead Time
Ready-To-Ship			
22755	Black	SEK 4.037,70	-
22757	Deep Red	SEK 4.037,70	-
22756	Grey	SEK 4.037,70	-

26% rabatt ska dras av på angivna priser

FINE SUSPENSION LAMP / 120 CM / 47.25"

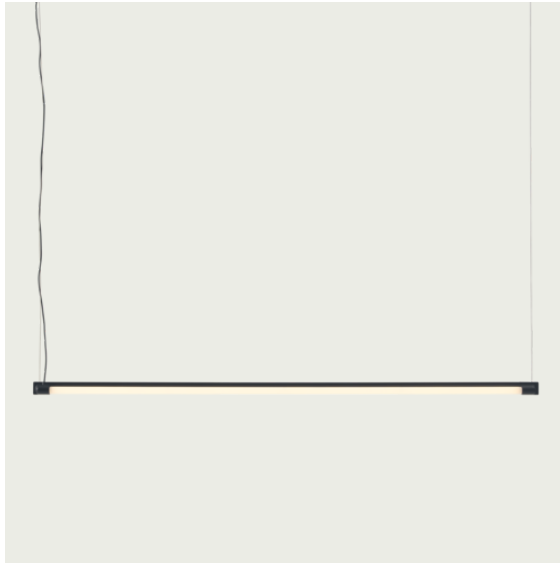

H 5,2 cm / 2.0"
W 25,5 cm / 9.7"
D 9,4 / 3.7"



W 120 cm / 47.2"
D 2,4 cm / 0.9"

Shipper Colli	1
Gross Weight (kg)	1.73
Net Weight (kg)	0.8
Bulb included	Yes. Integrated LED.
Warranty Period	5 years

Item No.	Color	Contract Price	Lead Time
Ready-To-Ship			
22760	Black	SEK 4.639,70	-
22762	Deep Red	SEK 4.639,70	-
22761	Grey	SEK 4.639,70	-

26% rabatt ska dras av på angivna priser

LEAF LAMP SERIES

"Combining a light and elegant design with an energy-efficient LED technology, the Leaf Lamp Series has a clean and refined expression. The asymmetric geometry of the design gives it an organic and friendly appearance, inspired by the leaves on a tree. Turn the Leaf Lamp according to your needs and discover how the lamp will subtly transform its shape, adding a graphic and gentle light silhouette to any space."

— Broberg & Ridderstråle



Designed by	Broberg & Ridderstråle
Environment	Indoor
Country of Production	China
Cord Length	180 cm / 71"
Light Source Included	Yes - integrated LED
Dimmable Function	Yes
Description	With its elegantly simple lines, the Leaf Lamp Series brings ambient as well as direct lighting to any space, paired with its organic shape that is inspired by the leaves of a tree. The design features a dimmable LED light alongside a turnable head, allowing for its user to position the light as desired for one's individual space and atmosphere.
Material	Aluminum, brass, colored PVC cord. Leaf is a result of a process combining turned and casted aluminum and steel, with a strong powder coating as paint. It has a build-in energy-efficient LED bulb with a Lumen Maintenance (Lifetime) of L90 BIO 35.000 hours.
Cleaning & Care	Wipe off dust with dry cloth. If necessary use moist cloth, then dry off. Do not use abrasive cleaning agents. Always switch off the electricity supply before cleaning.

TESTS & CERTIFICATIONS

EU:

IEC 60598-1 and IEC 60598-2-4

Low Voltage Directive (LVD) - 2014/35/EU

ECO Design Directive - 245/2009/EC

ROHS Directive - 2011/65/EU amended RoHS 3 Directive 2015/863

REACH Directive - EC/1907/2006

WEEE Directive - 2012/19/EU

UK:

BS EN 60598-1 and EN 60598-2-4

Electrical Equipment (Safety) Regulations 2016

Electromagnetic Compatibility Regulations 2016

The Restriction of the Use of Certain Hazardous Substances in Electrical and Electronic Equipment Regulations 2012

The Ecodesign for Energy-Related Products and Energy Information (Amendment) (EU Exit) Regulations 2019

USA/Canada:

UL STD. 153 / CSA STD. C22.2 NO.250.4

Australia/New Zealand:

AS/NZS 60598.1 and AS/NZS 60598.2.4

*Does not apply to the following colors: Copper Brown, Dark Green

26% rabatt ska dras av på angivna priser

LEAF TABLE LAMP



15,5 x 18,5 cm / 6" x 7.25"

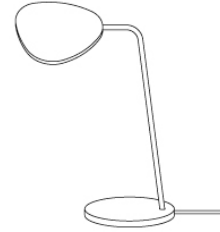

41,5 cm / 16.35"

18 cm / 7"

Shipper Colli	1
Gross Weight (kg)	2.5
Net Weight (kg)	1.75
Bulb included	Yes
Warranty Period	5 years

Item No.	Color	Contract Price	Lead Time
Ready-To-Ship			
13422	Black	SEK 2.536,10	-
13423	Copper Brown	SEK 2.536,10	-
13424	Dark Green	SEK 2.536,10	-
13420	Grey	SEK 2.536,10	-
13421	White	SEK 2.536,10	-

26% rabatt ska dras av på angivna priser

LEAF FLOOR LAMP

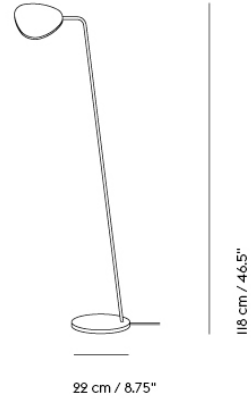
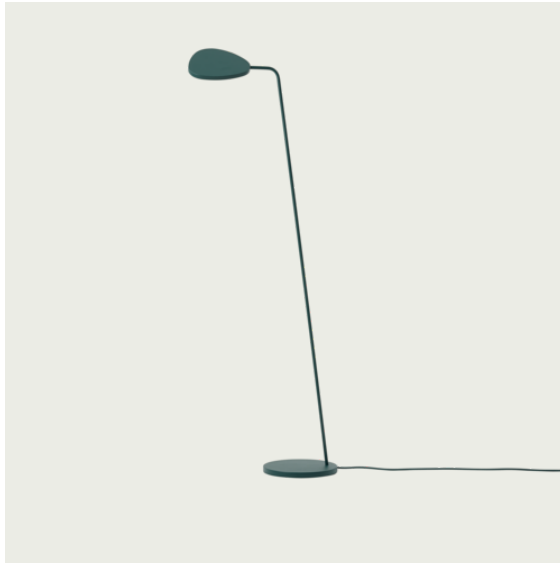

Shipper Colli	1
Gross Weight (kg)	5.2
Net Weight (kg)	2.8
Bulb included	Yes
Warranty Period	5 years

Item No.	Color	Contract Price	Lead Time
Ready-To-Ship			
13432	Black	SEK 3.482,10	-
13433	Copper Brown	SEK 3.482,10	-
13434	Dark Green	SEK 3.482,10	-
13430	Grey	SEK 3.482,10	-
13431	White	SEK 3.482,10	-

26% rabatt ska dras av på angivna priser

LINEAR LAMP SERIES

“The Linear Lamp Series is designed from the idea of creating smaller atmospheres through modern light, bringing a sense of intimacy to larger spaces. With their elegant expression, subtle details and inherent functionality, the designs create space for both being and working on your own as well as making for a friendly environment when in the company of others. Use the Linear Lamp Series in any space in need of modern, functional lighting.”

— Thomas Bentzen



Designed by	Thomas Bentzen
Environment	Indoor
Country of Production	China
Cord Length	Table Lamp: 250 cm / 98.4". Mounted Lamp: 150 cm / 59.1". Pendant Lamp: 400 cm / 157.5"
Light Source Included	Yes - integrated LED
Dimmable Function	Yes: Table Lamp and Mounted Lamp / No: Pendant Lamp
Description	Designed from the idea of creating smaller spaces within larger settings, the Linear Lamp Series by Thomas Bentzen is created with subtlety at its heart—simple lines, inviting functionalities and dimmable light that can be adjusted to any setting. The Linear Table & Mounted Lamps hint toward the archetypal library lamp with a modern expression, paired with the extensive functionality of dimmability. Available in two sizes, the Linear Mounted Lamp brings a friendly canopy of light to any space.
Material	Linear Pendant Lamp: Powder coated lamp head in pressure die-casted and extruded aluminum. Linear Table Lamp & Linear Mounted Lamp: Powder coated lamp head in extruded aluminum. Diffuser in polycarbonate. PVC cord.
Cleaning & Care	Clean with a moist cloth. If necessary, use a little dish soap on the cloth.

26% rabatt ska dras av på angivna priser

LINEAR LAMP SERIES

TESTS & CERTIFICATIONS

EU:

Linear Table / Linear Mounted:

IEC 60598-1 and IEC 60598-2-4

Linear Pendant:

IEC 60598-1 and IEC 60598-2-1

Low Voltage Directive (LVD) - 2014/35/EU

ECO Design Directive - 245/2009/EC

ROHS Directive - 2011/65/EU amended RoHS 3 Directive 2015/863

REACH Directive - EC/1907/2006

WEEE Directive - 2012/19/EU

UK:

Linear Table / Linear Mounted:

BS EN 60598-1 and EN 60598-2-4

Linear Pendant:

BS 4533-102.1, EN 60598-2-1

Electrical Equipment (Safety) Regulations 2016

Electromagnetic Compatibility Regulations 2016

The Restriction of the Use of Certain Hazardous Substances in Electrical and Electronic Equipment Regulations 2012

The Ecodesign for Energy-Related Products and Energy Information (Amendment) (EU Exit) Regulations 2019

US/Canada:

UL 153 / CSA C22.2 No. 250.4

Australia/New Zealand:

Linear Table / Linear Mounted:

AS/NZS 60598.1

AS/NZS 60598.2.4

Linear Pendant:

AS/NZS 60598.2.1

26% rabatt ska dras av på angivna priser

LINEAR TABLE LAMP



Shipper Colli	1
Gross Weight (kg)	1.832
Net Weight (kg)	1.3
Bulb included	Yes. Integrated LED.
Warranty Period	5 years

Item No.	Color	Contract Price	Lead Time
Ready-To-Ship			
22510	Black	SEK 2.536,10	-
22511	Grey	SEK 2.536,10	-

26% rabatt ska dras av på angivna priser

LINEAR PENDANT LAMP / 169,2 CM / 66.6"



W 169,2 cm / 66,6"
D 10,7 cm / 4,2"

Shipper Colli	1
Gross Weight (kg)	5.185
Net Weight (kg)	3.3
Bulb included	Yes. Integrated LED.
Warranty Period	5 years

Item No.	Color	Contract Price	Lead Time
Ready-To-Ship			
22518	Black	SEK 7.305,70	-
22519	Grey	SEK 7.305,70	-

26% rabatt ska dras av på angivna priser

LINEAR PENDANT LAMP / 87,2 CM / 34.3"



W 87,2 cm / 34,3"
D 10,7 cm / 4,2"

Shipper Colli	1
Gross Weight (kg)	3.485
Net Weight (kg)	2.2
Bulb included	Yes. Integrated LED.
Warranty Period	5 years

Item No.	Color	Contract Price	Lead Time
Ready-To-Ship			
22516	Black	SEK 5.546,10	-
22517	Grey	SEK 5.546,10	-

26% rabatt ska dras av på angivna priser

LINEAR MOUNTED LAMP / 209,2 CM / 82.4"

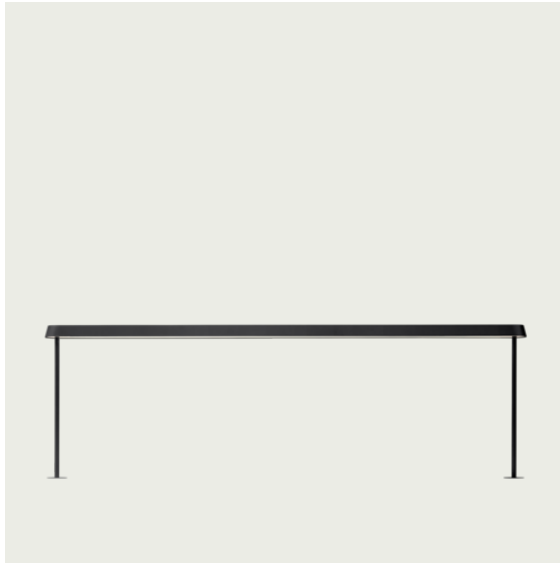

Shipper Colli	1
Gross Weight (kg)	7.78
Net Weight (kg)	5.3
Please note	The connector pins in this product contains lead, CAS no. 7439-99-1
Bulb included	Yes. Integrated LED.
Warranty Period	5 years

Item No.	Color	Contract Price	Lead Time
Ready-To-Ship			
22514	Black	SEK 10.315,70	-
22515	Grey	SEK 10.315,70	-

26% rabatt ska dras av på angivna priser

LINEAR MOUNTED LAMP / 23,2 CM / 9.1"



W 23,2 cm / 9.1"
D 10,7 cm / 4.2"

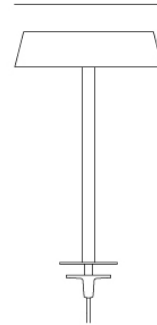

36,5 cm / 14.4"

Shipper Colli	1
Gross Weight (kg)	1.681
Net Weight (kg)	0.78
Please note	The connector pins in this product contains lead, CAS no. 7439-92-1
Bulb included	Yes. Integrated LED.
Warranty Period	5 years

Item No.	Color	Contract Price	Lead Time
Ready-To-Ship			
22512	Black	SEK 3.138,10	-
22513	Grey	SEK 3.138,10	-

26% rabatt ska dras av på angivna priser

GRAIN PENDANT LAMP

"The Grain Pendant Lamp is a versatile light with a warm and welcoming appearance, complemented by a soft form that generously spreads the light underneath. The design is made from a unique mix of bamboo grain and plastic, adding a new perspective to the archetypal pendant lamp through its visual expression and matte touch."

— Jens Fager



Designed by	Jens Fager
Environment	Indoor
Country of Production	China
Cord Length	400 cm / 157.5"
Light Source Included	Yes
Dimmable Function	Yes
Socket Size	G9
Ceiling Cap Included	Yes
Description	The traditional pendant silhouette receives a poetic reinterpretation with the Grain Lamp. Simple and elegant, the lamp has small grains of fiber in its surface, creating a subtle texture and change in the diffusion of light. The pendant includes an LED lightbulb that lasts for up to 10,000 hours and provides a warm, natural glow.
Material	Lamp Shade in mixture of bamboo fibers and polypropylene. PVC cord. The lamp's shade is made under high pressure casting. Shade and electrical components are hereafter assembled by hand.
Cleaning & Care	Clean with a moist cloth. Always switch off the electricity supply before cleaning.

26% rabatt ska dras av på angivna priser

GRAIN PENDANT LAMP

TESTS & CERTIFICATIONS

EU:

IEC 60598-1 and IEC 60598-2-1

Low Voltage Directive (LVD) - 2014/35/EU

ECO Design Directive - 245/2009/EC

ROHS Directive - 2011/65/EU amended RoHS 3 Directive 2015/863

REACH Directive - EC/1907/2006

WEEE Directive - 2012/19/EU

UK:

BS EN 60598-1 and BS 4533-102.1, EN 60598-2-1

Electrical Equipment (Safety) Regulations 2016

Electromagnetic Compatibility Regulations 2016

The Restriction of the Use of Certain Hazardous Substances in Electrical and Electronic Equipment Regulations 2012

The Ecodesign for Energy-Related Products and Energy Information (Amendment) (EU Exit) Regulations 2019

USA/Canada:

UL STD. 1598 / CSA STD. C22.2 NO.250.0

Australia/New Zealand:

AS/NZS 60598.1 and AS/NZS 60598.2.1

China:

GB 7000.201 and GB 7000.1

26% rabatt ska dras av på angivna priser

GRAIN PENDANT LAMP

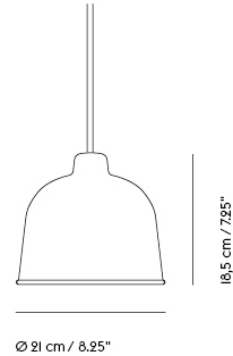

Shipper Colli	1
Gross Weight (kg)	1.17
Net Weight (kg)	0.76
Bulb included	Yes
Warranty Period	5 years

Item No.	Color	Contract Price	Lead Time
Ready-To-Ship			
12237	Black	SEK 1.504,10	-
12239	Blue-Grey	SEK 1.504,10	-
12238	Dark Green	SEK 1.504,10	-
12235	Dusty Green	SEK 1.504,10	-
12232	Grey	SEK 1.504,10	-
12233	Nature	SEK 1.504,10	-
Extras			
15801	Grain / Rime Ø12+Ø18+25 Cord - Black (per linear meter)	SEK 59,30	-
60285	Grain Cord - Blue-Grey (per linear meter)	SEK 59,30	-
60284	Grain Cord - Dark Green (per linear meter)	SEK 59,30	-
60282	Grain Cord - Dusty Green (per linear meter)	SEK 59,30	-
60280	Grain Cord - Grey (per linear meter)	SEK 59,30	-
60281	Grain Cord - Nature (per linear meter)	SEK 59,30	-
24050	Ceiling Cap - White	SEK 116,10	-
21100	Dimmable Bulb for Fluid Small and Grain Pendant Lamp	SEK 193,50	-

26% rabatt ska dras av på angivna priser

PITON PORTABLE LAMP

"My idea for Piton started from the desire to create a rechargeable portable lamp that could be adapted in a multitude of ways while functioning in various environments. I wanted the design to fulfill the inherent needs of a torch; providing security and warmth while clearly illuminating your field of vision. Piton takes its name from a climbing apparatus that is jammed into cracks and crevices on mountainsides to which the climber can attach hooks, tools and ropes while rigging it in various positions; an element that is also present in the design of the Piton Portable Lamp."

— Tom Chung



Designed by	Tom Chung
Environment	Indoor / Outdoor
Country of Production	China
Cord Length	300 cm textile USB cable (no power adapter included)
Light Source Included	Yes - integrated LED
Dimmable Function	Yes - Continuous
Description	Piton is an untraditional take on the battery-powered portable lamp, playfully referencing the archetypal flashlight. Refined anodized extruded aluminum enhances its elegant form and distinct functionality inspired by tools used for mountain climbing. It is a versatile ambient light with 6 hours of battery life on 100% brightness and 13,5 hours on 50% brightness that can be used lying, standing, tilting on a shelf or suspended, depending on the space or spot you want to illuminate, effortlessly moving between indoors and outdoors.
Material	Battery-powered portable lamp with 6 hours of battery life on 100% brightness and 13,5 hours on 50% brightness. Continuous dim function. Body made from anodized extruded aluminum. Lamp shade made in injection molded plastic with an integrated and replaceable LED light bulb. Comes with a woven fabric USB-C cable for charging. The Piton Portable Lamp is suitable for outdoor use with an IP54 rating. The lamp is protected and tested against solid foreign objects, such as dust ingress, as well as liquids, such as water splashes, from all angles.
Cleaning & Care	Clean with a moist cloth. If necessary, use a little dish soap on the cloth. Always switch off the electricity supply before cleaning.

TESTS & CERTIFICATIONS

EU:

ECO Design Directive - 245/2009/EC

ROHS Directive - 2011/65/EU amended RoHS 3 Directive 2015/863

REACH Directive - EC/1907/2006

WEEE Directive - 2012/19/EU

Electromagnetic compatibility - EN IEC 55015 / EN IEC 61000 / EN 61547

UK:

The Restriction of the Use of Certain Hazardous Substances in Electrical and Electronic Equipment Regulations 2012

The Ecodesign for Energy-Related Products and Energy Information (Amendment) (EU Exit) Regulations 2019

Electromagnetic compatibility - BS EN 6100 / BS EN IEC 55015 / BS EN 61547

Australia/New Zealand:

AS/NZS 60598.1 / 60598.2.4

AS/NZS 61347.1 / 61347.2.13

IEC 62031

IEC TR62778

26% rabatt ska dras av på angivna priser

PITON PORTABLE LAMP



13,2 cm / 5.2"

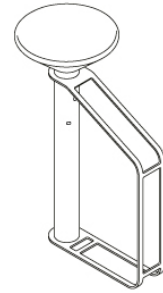

32,1 cm / 12.6"

21,8 cm / 8.6"

Shipper Colli	1
Gross Weight (kg)	1.45
Net Weight (kg)	0.55
Bulb included	Yes. Integrated, dimmable, replaceable LED module.
Warranty period	5 years

Item No.	Color	Contract Price	Lead Time
Ready-To-Ship			
22581	Aluminum	SEK 1.973,70	-
22580	Black	SEK 1.973,70	-

26% rabatt ska dras av på angivna priser

POST LAMP SERIES

"The Post Lamp Series came from the idea of exploring the flexibility of the magnetic joint, giving the user the freedom to position and dim the lamp's light units according to individual needs. Designed with a sculptural expression, simple lines and a refined finish, the Post Lamp Series represents a new perspective through its graphic character and forward-thinking functionality."

— Earnest Studio



Designed by	Earnest Studio
Environment	Indoor
Country of Production	China
Cord Length	Lighting units: 250 cm / 98.4" / Power Hub: 200 cm / 78.7"
Light Source Included	Yes - integrated LED
Dimmable Function	Yes
Description	The Post Lamp Series is an innovative lighting design with an archetypal appearance, graphic character and forward-thinking functionalities. Exploring the utmost flexibility of a magnetic joint, the user can position, dim and turn the lamp according to individual needs. Arrange the cord of the design in linear or playful formations on the wall, using its cable drop. Additional lighting units can be purchased as spare part and plugged into power hub.
Material	Lighting unit in powder coated magnesium with silicone cord and acrylic opal diffuser. Power hub in powder coated plastic with PVC cord. Post Wall Lamp: Wall mounting bracket in powder coated steel. Wall cable drops in powder coated steel with magnet and repositionable adhesive tape. Post Floor Lamp: Base in powder coated steel. Cable drops in powder coated plastic with magnet.
Cleaning & Care	Clean with soft dry cloth only. Always switch off the electricity supply before cleaning.

26% rabatt ska dras av på angivna priser

POST LAMP SERIES

TESTS & CERTIFICATIONS

EU:

IEC 60598-1 and IEC 60598-2-4

Low Voltage Directive (LVD) - 2014/35/EU

ECO Design Directive - 245/2009/EC

ROHS Directive - 2011/65/EU amended RoHS 3 Directive 2015/863

REACH Directive - EC/1907/2006

WEEE Directive - 2012/19/EU

UK:

BS EN 60598-1 and EN 60598-2-4

Electrical Equipment (Safety) Regulations 2016

Electromagnetic Compatibility Regulations 2016

The Restriction of the Use of Certain Hazardous Substances in Electrical and Electronic Equipment Regulations 2012

The Ecodesign for Energy-Related Products and Energy Information (Amendment) (EU Exit) Regulations 2019

The Eurasian Economic Union:

TP TC 004 and TP TC 020

USA/Canada:

UL STD. 153 / CSA STD. C22.2 NO.250.4

Australia/New Zealand:

AS/NZS 60598.1 / 60598.2.4

26% rabatt ska dras av på angivna priser

POST WALL LAMP

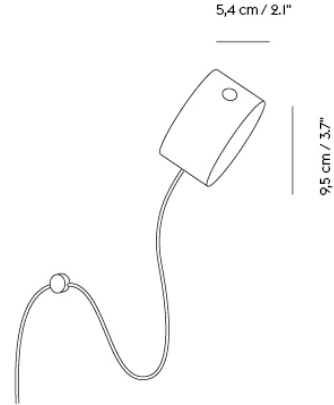

Shipper Colli	1
Gross Weight (kg)	1.05
Net Weight (kg)	0.55
Bulb included	Yes. Integrated non-replaceable LED
Warranty Period	5 years

Item No.	Color	Contract Price	Lead Time
Ready-To-Ship			
22601	Black	SEK 2.536,10	-
Extras			
22509	Extra Wall Mount - Black	SEK 210,70	-
22499	Extra Cable Drops - Black ***	SEK 270,90	-
22602	Extra Lighting Unit - Black	SEK 2.192,10	-

26% rabatt ska dras av på angivna priser

POST FLOOR LAMP

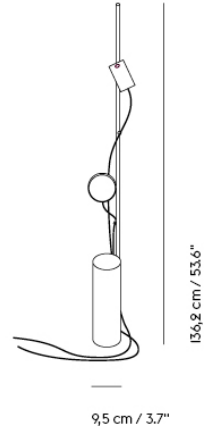

Shipper Colli	1
Gross Weight (kg)	12,5
Net Weight (kg)	10,2
Bulb included	Yes. Integrated non-replaceable LED
Warranty Period	5 years

Item No.	Color	Contract Price	Lead Time
Ready-To-Ship			
22600	Black	SEK 6.015,70	-
Extras			
22386	Extra Cable Drops - Black	SEK 270,90	-
22602	Extra Lighting Unit - Black	SEK 2.192,10	-

26% rabatt ska dras av på angivna priser

PULL FLOOR LAMP

"The Pull Floor Lamp brings a new perspective to the traditional floor light through its playful personality and warm, Scandinavian materials. With its partially hidden cord connecting the elements of the design and allowing for adjusting of its shade, the Pull Lamp can be tweaked to the mood and needs of any space, enhancing the expression of the design as well as the ambience of the room."

— Whatswhat



Designed by	Whatswhat
Environment	Indoor
Country of Production	Denmark
Cord Length	200 cm / 78,7"
Light Source Included	No
Dimmable Function	Yes - dimmable switch included
Socket Size	E27
Description	Taking cues from the materiality of Scandinavian design with a playful approach, the Pull Floor Lamp's combines the warmth of oak with an adjustable shade, allowing for its direction of light to be altered according to your given spatial needs.
Material	Natural oak wood with white covered plast composite. Wood parts are handmade by manual lathe and wood carving machines. Shade is hand crafted and handled carefully through every step. Cord in PVC.
Cleaning & Care	Wipe off dust with dry cloth. If necessary use moist cloth, then dry off. Always clean along the grains of the wood. Always switch off the electricity supply before cleaning.

TESTS & CERTIFICATIONS

EU:

IEC 60598-1 and IEC 60598-2-4

Low Voltage Directive (LVD) - 2014/35/EU

ECO Design Directive - 245/2009/EC

ROHS Directive - 2011/65/EU amended RoHS 3 Directive 2015/863

REACH Directive - EC/1907/2006

WEEE Directive - 2012/19/EU

UK:

BS EN 60598-1 and EN 60598-2-4

Electrical Equipment (Safety) Regulations 2016

Electromagnetic Compatibility Regulations 2016

The Restriction of the Use of Certain Hazardous Substances in Electrical and Electronic Equipment Regulations 2012

The Ecodesign for Energy-Related Products and Energy Information (Amendment) (EU Exit) Regulations 2019

USA/Canada:

UL STD. 153 / CSA STD. C22.2 NO.250.4

26% rabatt ska dras av på angivna priser

PULL FLOOR LAMP

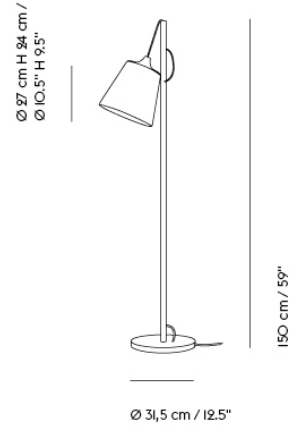

Shipper Colli 1
Gross Weight (kg) 7
Net Weight (kg) 3
Bulb included
Warranty Period 5 years

Item No.	Color	Contract Price	Lead Time
Ready-To-Ship			
12044	Oak/White	SEK 5.116,10	-

26% rabatt ska dras av på angivna priser

RIME PENDANT LAMP

"Designing simple things is often one of the hardest things to do. We wanted to create a simple lamp with a glass shape, giving it a soft expression while making its top and pendant tube as subtle as possible. We were inspired by the shape of acorns for the gentle lines of the pendant while hinting towards the shaded expression of ice and rime for the glass of the design, allowing for the light to shine slightly through with a refined touch. The Rime Pendant Lamp brings a timeless yet modern perspective to the archetypal light through its translucent shade and graphic form."

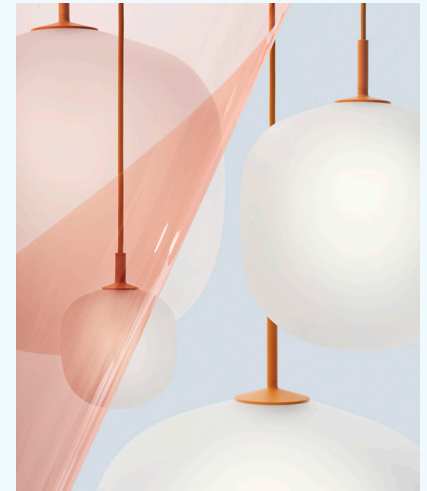

— TAF Studio

Designed by	TAF Studio
Environment	Indoor
Country of Production	Poland
Cord Length	400 cm / 157.5"
Light Source Included	Ø12 and Ø18: Yes / Ø25, Ø37 and Ø45: No
Dimmable Function	Yes - If dimmable bulb is used
Socket Size	Ø12 and Ø18: G9 / Ø25: E14 / Ø37 and Ø45: E27
Ceiling Cap Included	Yes - for pendant lamp Ø12, Ø18 and Ø25: Ø9 / 3.5" H 5,6 cm / 2.2 Ø37 and Ø45: Ø11 / 4.3" H 3,5 / 1.4"
Description	<p>The Rime Lamp Series brings an elegant perspective to the glass light through its semitransparent glass that has been sandblasted for a refined expression. The design features a characteristic form, inspired by the shape of acorns, complemented by its powder coated elements for a subtle touch.</p> <p>*Please note that the availability of sizes and/or colors of this product are subject to regional stock levels.</p>
Material	<p>Pendant: Mouth-blown glass shade. Aluminum, powder coated top-piece and pendant tube. PVC cord.</p> <p>Wall lamp: Mouth-blown glass shade. Wall bracket in aluminum, pressure die-casted and powder coated.</p> <p>Wall bracket in steel and chrome plated.</p>
Cleaning & Care	Clean with a moist cloth. If necessary, use a little dish soap on the cloth. Always switch off the electricity supply before cleaning.

26% rabatt ska dras av på angivna priser

RIME PENDANT LAMP

TESTS & CERTIFICATIONS

EU:

IEC 60598-1 and IEC 60598-2-1

Low Voltage Directive (LVD) - 2014/35/EU

ECO Design Directive - 245/2009/EC

ROHS Directive - 2011/65/EU amended RoHS 3 Directive 2015/863

REACH Directive - EC/1907/2006

WEEE Directive - 2012/19/EU

UK:

BS EN 60598-1 and BS 4533-102.1, EN 60598-2-1

Electrical Equipment (Safety) Regulations 2016

Electromagnetic Compatibility Regulations 2016

The Restriction of the Use of Certain Hazardous Substances in Electrical and Electronic Equipment Regulations 2012

The Ecodesign for Energy-Related Products and Energy Information (Amendment) (EU Exit) Regulations 2019

USA/Canada*:

UL STD. 1598 / CSA STD. C22.2 NO.250.0

Australia/New Zealand**:

AS/NZS 60598.1 and AS/NZS 60598.2.1

* Does not apply to Rime Ø12 and Rime Wall

** Does not apply to Rime Wall

26% rabatt ska dras av på angivna priser

RIME PENDANT LAMP / Ø 12 CM / 4.7"

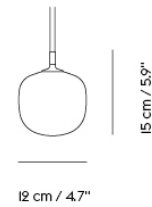
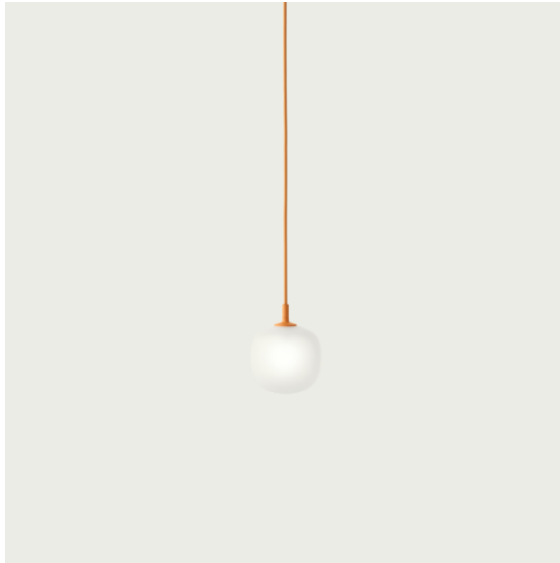

Shipper Colli	1
Gross Weight (kg)	2.1
Net Weight (kg)	0.8
Bulb included	Yes
Warranty Period	5 years

Item No.	Color	Contract Price	Lead Time
Ready-To-Ship			
22414	Black	SEK 1.973,70	-
22240	Deep Red	SEK 1.973,70	-
22418	Grey	SEK 1.973,70	-
22422	Orange	SEK 1.973,70	-
22410	White	SEK 1.973,70	-
Extras			
22540	Rime Cord for Ø12+Ø18+25 - Grey (per linear meter)	SEK 34,00	-
22541	Rime Cord Ø12+Ø18+25 cm - Orange (per linear meter)	SEK 34,00	-
15804	Fluid / Rime Ø12+Ø18+25 Cord - White (per linear meter)	SEK 59,30	-
15801	Grain / Rime Ø12+Ø18+25 Cord - Black (per linear meter)	SEK 59,30	-
15800	Rime Cord for Ø12+Ø18+25 - Deep Red (per linear meter)	SEK 59,30	-

26% rabatt ska dras av på angivna priser

RIME PENDANT LAMP / Ø 18 CM / 7.1"

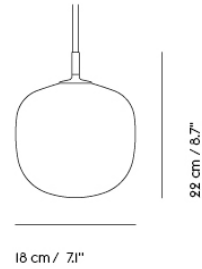

Shipper Colli	1
Gross Weight (kg)	1.912
Net Weight (kg)	0.712
Bulb included	Yes
Warranty Period	5 years

Item No.	Color	Contract Price	Lead Time
Ready-To-Ship			
22251	Black	SEK 2.364,10	-
22254	Deep Red	SEK 2.364,10	-
22252	Grey	SEK 2.364,10	-
22253	Orange	SEK 2.364,10	-
22250	White	SEK 2.364,10	-
Extras			
22540	Rime Cord for Ø12+Ø18+25 - Grey (per linear meter)	SEK 34,00	-
22541	Rime Cord Ø12+Ø18+25 cm - Orange (per linear meter)	SEK 34,00	-
15804	Fluid / Rime Ø12+Ø18+25 Cord - White (per linear meter)	SEK 59,30	-
15801	Grain / Rime Ø12+Ø18+25 Cord - Black (per linear meter)	SEK 59,30	-
15800	Rime Cord for Ø12+Ø18+25 - Deep Red (per linear meter)	SEK 59,30	-

26% rabatt ska dras av på angivna priser

RIME PENDANT LAMP / Ø 25 CM / 9.8"

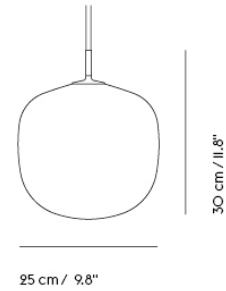

Shipper Colli	1
Gross Weight (kg)	3.4
Net Weight (kg)	1.5
Bulb included	
Warranty Period	5 years

Item No.	Color	Contract Price	Lead Time
Ready-To-Ship			
22415	Black	SEK 3.138,10	-
22241	Deep Red	SEK 3.138,10	-
22419	Grey	SEK 3.138,10	-
22423	Orange	SEK 3.138,10	-
22411	White	SEK 3.138,10	-
Extras			
22540	Rime Cord for Ø12+Ø18+25 - Grey (per linear meter)	SEK 34,00	-
22541	Rime Cord Ø12+Ø18+25 cm - Orange (per linear meter)	SEK 34,00	-
15804	Fluid / Rime Ø12+Ø18+25 Cord - White (per linear meter)	SEK 59,30	-
15801	Grain / Rime Ø12+Ø18+25 Cord - Black (per linear meter)	SEK 59,30	-
15800	Rime Cord for Ø12+Ø18+25 - Deep Red (per linear meter)	SEK 59,30	-

26% rabatt ska dras av på angivna priser

RIME PENDANT LAMP / Ø 37 CM / 14.6"

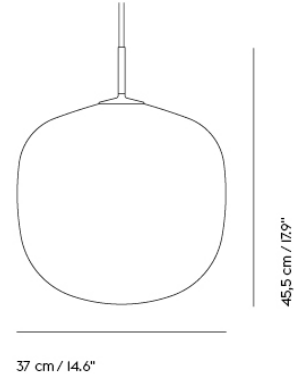

Shipper Colli	1
Gross Weight (kg)	6.5
Net Weight (kg)	3.5
Bulb included	
Warranty Period	5 years

Item No.	Color	Contract Price	Lead Time
Ready-To-Ship			
22416	Black	SEK 4.295,70	-
22242	Deep Red	SEK 4.295,70	-
22420	Grey	SEK 4.295,70	-
22424	Orange	SEK 4.295,70	-
22412	White	SEK 4.295,70	-
Extras			
22542	Rime Cord Ø37 + 45 cm - Black (per linear meter)	SEK 69,00	-
22549	Rime Cord Ø37 + 45 cm - Deep Red (per linear meter)	SEK 69,00	-
22545	Rime Cord Ø37 + 45 cm - Grey (per linear meter)	SEK 69,00	-
22546	Rime Cord Ø37 + 45 cm - Orange (per linear meter)	SEK 69,00	-
22543	Rime Cord Ø37 + 45 cm - White (per linear meter)	SEK 69,00	-

26% rabatt ska dras av på angivna priser

RIME PENDANT LAMP / Ø 45 CM / 17.7"

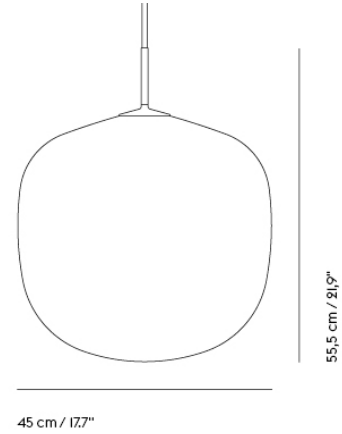

Shipper Colli	1
Gross Weight (kg)	8.5
Net Weight (kg)	4
Bulb included	
Warranty Period	5 years

Item No.	Color	Contract Price	Lead Time
Ready-To-Ship			
22417	Black	SEK 5.804,10	-
22243	Deep Red	SEK 5.804,10	-
22421	Grey	SEK 5.804,10	-
22425	Orange	SEK 5.804,10	-
22413	White	SEK 5.804,10	-
Extras			
22542	Rime Cord Ø37 + 45 cm - Black (per linear meter)	SEK 69,00	-
22549	Rime Cord Ø37 + 45 cm - Deep Red (per linear meter)	SEK 69,00	-
22545	Rime Cord Ø37 + 45 cm - Grey (per linear meter)	SEK 69,00	-
22546	Rime Cord Ø37 + 45 cm - Orange (per linear meter)	SEK 69,00	-
22543	Rime Cord Ø37 + 45 cm - White (per linear meter)	SEK 69,00	-

26% rabatt ska dras av på angivna priser

RIME WALL LAMP

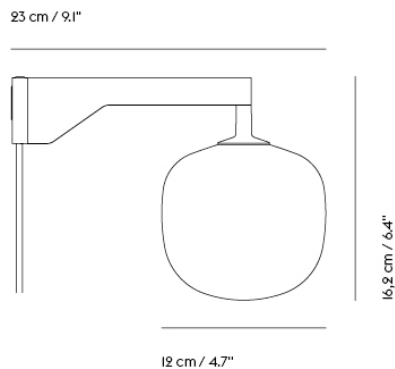

Shipper Colli	1
Gross Weight (kg)	0.694
Net Weight (kg)	0.3
Bulb included	Yes
Warranty Period	5 years

Item No.	Color	Contract Price	Lead Time
Ready-To-Ship			
22427	Black	SEK 3.005,70	-
22428	Grey	SEK 3.005,70	-
22429	Orange	SEK 3.005,70	-
22426	White	SEK 3.005,70	-

26% rabatt ska dras av på angivna priser

STRAND LAMP SERIES

"The Strand Pendant Lamp is formed from a sprayed cocoon material with its cloud-like appearance that tightly clings to a spinning steel frame. It consists of tiny strands for a complex, intriguing structure that shrouds the light source while acting as its diffuser. With its see-through expression, the cocoon material allows for the Strand Pendant Lamp to filter light for a warm, comfortable glow. Designed in various sizes and shapes, the Strand Pendant Lamp hovers lightly in space, bringing comfort, harmony and a refined sensitivity into any room."

— Benjamin Hubert



Designed by	Benjamin Hubert
Environment	Indoor
Country of Production	Italy
Cord Length	Ø28 & Ø40: 300 cm / 118.1" Ø45, Ø60 & Ø80: 500 cm / 196.9" Table: 250 cm / 98.4"
Light Source Included	No
Dimmable Function	Yes - if dimmable bulb is used
Socket Size	E27
Ceiling Cap Included	Yes
Description	<p>The Strand Pendant Lamp is designed with soft, playful forms for a modern expression. The design provides both diffused lighting and direct lighting, the latter through its top and bottom opening. The design is made in a sprayed cocoon material that consists of tiny strands for a complex, intriguing structure that, paired with its modern form, gives the Strand Pendant Lamp an almost cloud-like appearance. With its cocoon material filtering light through for a warm, comfortable glow, the Strand Pendant Lamp hovers lightly in space, bringing comfort, harmony and a refined sensitivity to any room.</p> <p>The Strand Table Lamp references design history while remaining distinctly modern. Its shape is soft and playful, a sculptural design fitted with a hidden light source that illuminates the whole of its monolithic form. The lamp is made in a sprayed cocoon material that consists of tiny strands for a complex, intriguing structure that gives the Strand Table Lamp an almost cloud-like appearance. Filtering light through for a warm, comfortable glow, it brings a sense of comfort, harmony and a refined sensitivity to any room.</p>
Material	<p>The Strand Pendant Lamp is made of a cocoon layer with an inner steel structure, a PVC cord and PVC covered steel wire.</p> <p>The Strand Table Lamp is made of a cocoon layer with inner steel structure, base in iron and aluminum, PVC cord with inline dimmer.</p>
Cleaning & Care	Clean with soft dry cloth only. Always switch off the electricity supply before cleaning.
Additional info	Please note that the Open Ø60, Closed Ø45, Ø60 and Ø80 come with a wire suspension system with three metal wires. Metal wires 490 cm. Cord length 500 cm. Total possible suspension length from ceiling 480 cm.

26% rabatt ska dras av på angivna priser

STRAND LAMP SERIES

TESTS & CERTIFICATIONS

EU:

IEC 60598-1 and IEC 60598-2-1

Low Voltage Directive (LVD) - 2014/35/EU

ECO Design Directive - 245/2009/EC

ROHS Directive - 2011/65/EU amended RoHS 3 Directive 2015/863

REACH Directive - EC/1907/2006

WEEE Directive - 2012/19/EU

UK:

BS EN 60598-1 and BS 4533-102.1, EN 60598-2-1

Electrical Equipment (Safety) Regulations 2016

Electromagnetic Compatibility Regulations 2016

The Restriction of the Use of Certain Hazardous Substances in Electrical and Electronic Equipment Regulations 2012

The Ecodesign for Energy-Related Products and Energy Information (Amendment) (EU Exit) Regulations 2019

USA/Canada:

UL STD. 1598 / CSA STD. C22.2 NO.250.0

Australia/New Zealand:*

AS/NZS 60598.1 and AS/NZS 60598.2.1

The Eurasian Economic Union:

TP TC 004 and TP TC 020

China:*

GB 7000.201 and GB 7000.1

* Does not apply to Strand Table Lamp

26% rabatt ska dras av på angivna priser

STRAND PENDANT LAMP / OPEN - Ø 28 CM / 11"

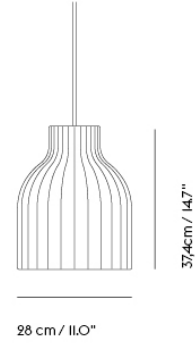

Shipper Colli 1
Gross Weight (kg) 2.35
Net Weight (kg) 1.4
Bulb included
Warranty Period 5 years

Item No.	Color	Contract Price	Lead Time
Ready-To-Ship			
22450	White - Open	SEK 3.435,70	-

26% rabatt ska dras av på angivna priser

STRAND PENDANT LAMP / OPEN Ø 40 CM / 16"

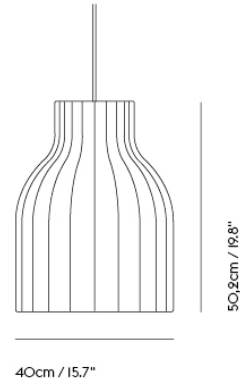

Shipper Colli	1
Gross Weight (kg)	3.7
Net Weight (kg)	2.1
Bulb included	
Warranty Period	5 years

Item No.	Color	Contract Price	Lead Time
Ready-To-Ship			
22451	White - Open	SEK 4.639,70	-

26% rabatt ska dras av på angivna priser

STRAND PENDANT LAMP / OPEN - Ø 60 CM / 23.5"

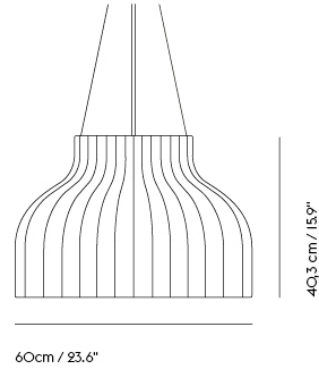

Shipper Colli 1
Gross Weight (kg) 6.6
Net Weight (kg) 4.05
Bulb included
Warranty Period 5 years

Item No.	Color	Contract Price	Lead Time
Ready-To-Ship			
22452	White - Open	SEK 6.359,70	-

26% rabatt ska dras av på angivna priser

STRAND PENDANT LAMP / CLOSED Ø 45 CM / 17.7"

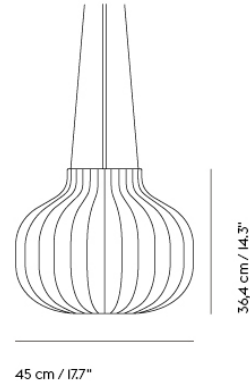
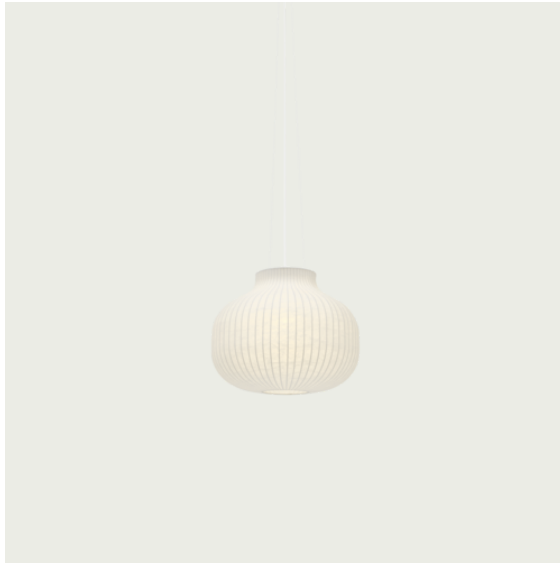

Shipper Colli 1
Gross Weight (kg) 4.29
Net Weight (kg) 2.1
Bulb included
Warranty Period 5 years

Item No.	Color	Contract Price	Lead Time
Ready-To-Ship			
22368	White - Closed	SEK 5.202,10	-

26% rabatt ska dras av på angivna priser

STRAND PENDANT LAMP / CLOSED - Ø
60 CM / 23.5"

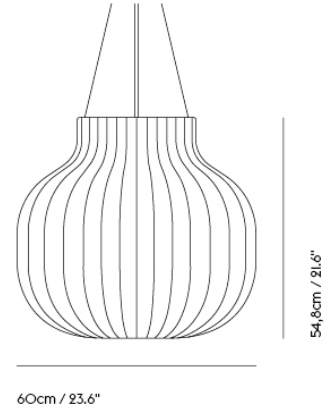

Shipper Colli 1
Gross Weight (kg) 8.4
Net Weight (kg) 5.4
Bulb included
Warranty Period 5 years

Item No.	Color	Contract Price	Lead Time
Ready-To-Ship			
22453	White - Closed	SEK 6.922,10	-

26% rabatt ska dras av på angivna priser

STRAND PENDANT LAMP / CLOSED - Ø
80 CM / 31.5"

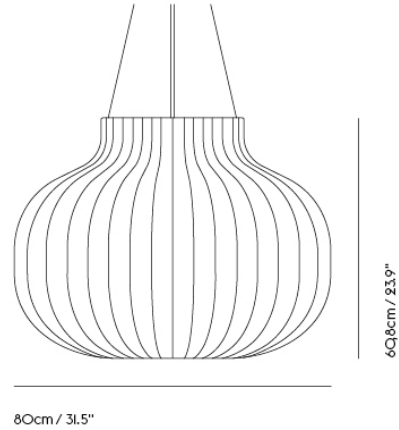

Shipper Colli 1
Gross Weight (kg) 11.05
Net Weight (kg) 6.35
Bulb included
Warranty Period 5 years

Item No.	Color	Contract Price	Lead Time
Ready-To-Ship			
22454	White - Closed	SEK 8.642,10	-

26% rabatt ska dras av på angivna priser

STRAND TABLE LAMP

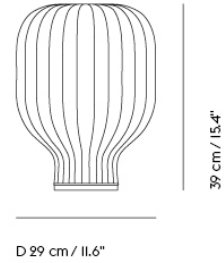

Shipper Colli 1
Gross Weight (kg) 5
Net Weight (kg) 2.9
Bulb included
Warranty Period 5 years

Item No.	Color	Contract Price	Lead Time
Ready-To-Ship			
22729	White	SEK 5.116,10	-

26% rabatt ska dras av på angivna priser

TIP LAMP SERIES

"The Tip Lamp Series is a simplistic and friendly design featuring a characteristic architectural silhouette. During the design process, we focused on polishing every single detail alongside the design's functionality. I wanted to reduce the design to the very essence of its purpose—intending to create a product that anyone would understand and be able to use in their daily lives. Its molded body gives the Tip Lamp Series a clean and precise look, highlighting its appearance of quality."

— Jens Fager

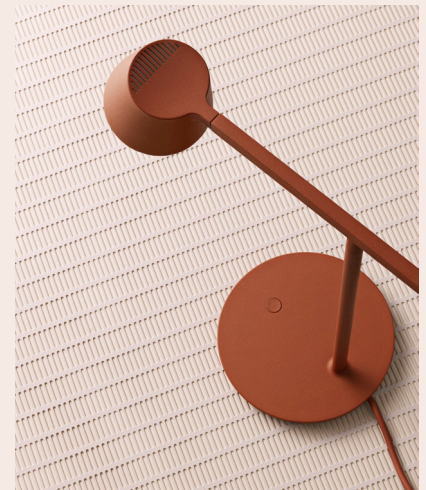

Designed by	Jens Fager
Environment	Indoor
Country of Production	China
Cord Length	250 cm / 98.5"
Light Source Included	Yes - integrated LED
Dimmable Function	Yes
Description	Created from the idea of stripping a design down to its essentials, the Tip Lamp Series is an example of simple, functional design with careful attention to detail. Offering direct as well as ambient light, the lamp's adjustable head feature an opal diffuser and dimmer function that effortlessly alters the volume of light.
Material	Casted and extruded aluminum. It has a build-in energy-efficient LED bulb with a Lumen Maintenance (Lifetime) of L90 BIO 35.000 hours. Cord in PVC.
Cleaning & Care	Clean with soft dry cloth only. Always switch off the electricity supply before cleaning.

TESTS & CERTIFICATIONS

EU:

Tip Table / Tip Floor: IEC 60598-1 and IEC 60598-2-4

Tip Wall: IEC 60598-1 and IEC 60598-2-1

Low Voltage Directive (LVD) - 2014/35/EU

ECO Design Directive - 245/2009/EC

ROHS Directive - 2011/65/EU amended RoHS 3 Directive 2015/863

REACH Directive - EC/1907/2006

WEEE Directive - 2012/19/EU

UK:

Tip Table / Tip Floor: BS EN 60598-1 and EN 60598-2-4

Tip Wall: BS EN 60598-1 and BS 4533-102.1, EN 60598-2-1

Electrical Equipment (Safety) Regulations 2016

Electromagnetic Compatibility Regulations 2016

The Restriction of the Use of Certain Hazardous Substances in Electrical and Electronic Equipment Regulations 2012

The Ecodesign for Energy-Related Products and Energy Information (Amendment) (EU Exit) Regulations 2019

USA/Canada:

Tip Table & Tip Wall: UL STD. I53 / CSA STD. C22.2 NO.250.4

Tip Wall: UL STD. I598 / CSA STD. C22.2 NO.250.0

Australia/New Zealand*:

Tip Table & Tip Wall: AS/NZS 60598.1 and AS/NZS 60598.2.4

Tip Wall: AS/NZS 60598.1 and AS/NZS 60598.2.1

*Does not apply to the following colors: Copper Brown, Grey

*Does not apply to Tip Floor Lamp

26% rabatt ska dras av på angivna priser

TIP TABLE LAMP



Shipper Colli	1
Gross Weight (kg)	2.4
Net Weight (kg)	1.5
Bulb included	Yes. Integrated LED.
Warranty Period	5 years

Item No.	Color	Contract Price	Lead Time
Ready-To-Ship			
22321	Black	SEK 2.536,10	-
22323	Copper Brown	SEK 2.536,10	-
22320	Grey	SEK 2.536,10	-
22322	White	SEK 2.536,10	-

26% rabatt ska dras av på angivna priser

TIP FLOOR LAMP

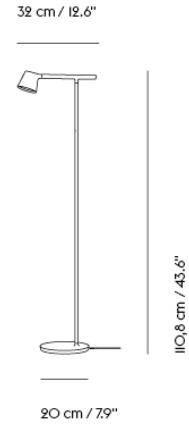
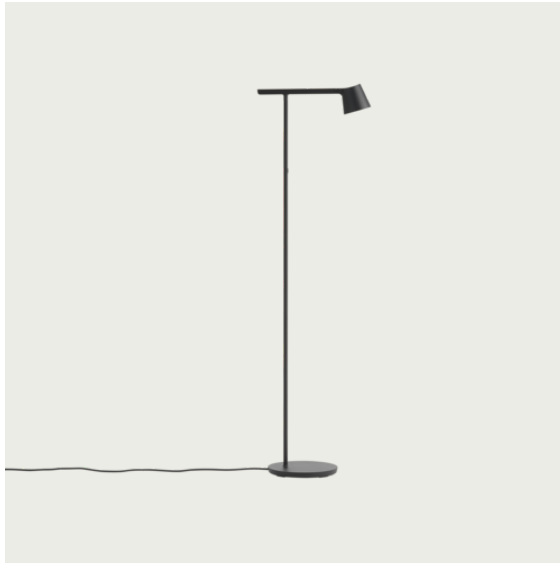

Shipper Colli	1
Gross Weight (kg)	5.6
Net Weight (kg)	2.65
Bulb included	Yes. Integrated LED.
Warranty Period	5 years

Item No.	Color	Contract Price	Lead Time
Ready-To-Ship			
22317	Black	SEK 4.037,70	-
22316	Grey	SEK 4.037,70	-
22318	White	SEK 4.037,70	-

26% rabatt ska dras av på angivna priser

TIP WALL LAMP

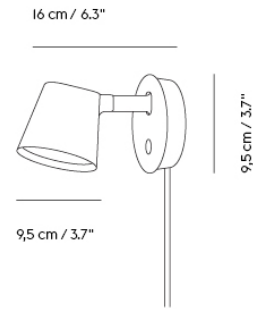

Shipper Colli	1
Gross Weight (kg)	0.75
Net Weight (kg)	0.45
Bulb included	Yes. Integrated LED.
Warranty Period	5 years

Item No.	Color	Contract Price	Lead Time
Ready-To-Ship			
22326	Black	SEK 1.762,10	-
22328	Copper Brown	SEK 1.762,10	-
22325	Grey	SEK 1.762,10	-
22327	White	SEK 1.762,10	-

26% rabatt ska dras av på angivna priser

TOP PENDANT LAMP

"Top Lamp is our interpretation of the archetypical cone-shaped pendant, with a universal and simple design. The lamp's distinctive top encases its most innovative part—the energy-efficient LED light source. Manufactured in spun steel with a graphic rolled hem, the versatile series offers an array of sizes and colors and is as much at home above a bustling bistro table as in the intimate ambiance of a living room."



— Big-Game

Design by	Big-Game
Environment	Indoor
Country of Production	China
Cord Length	400 cm / 197"
Light Source Included	Yes
Dimmable Function	Yes
Socket Size	GX53
Ceiling Cap Included	Yes
Description	With its universal and simple design, Top Pendant Lamp is a contemporary reinterpretation of the archetypical cone-shaped pendant. Its top is a striking feature designed to neatly fit its compact LED light source. Manufactured in spun steel with a graphic rolled hem, it is a versatile lighting family that offers an array of opportunities in color, size and function.
Material	Spun steel shade with a high gloss powder paint finish. PVC cord. Socket and canopy in ABS. GX53 light bulb included.
Cleaning & Care	Clean the lamp with a soft dry cloth only. Always switch off electricity supply before cleaning.

TESTS & CERTIFICATIONS

EU:
IEC 60598-1 and IEC 60598-2-1
Low Voltage Directive (LVD) - 2014/35/EU
ECO Design Directive - 245/2009/EC
ROHS Directive - 2011/65/EU amended RoHS 3 Directive 2015/863
REACH Directive - EC/1907/2006

UK:
BS EN 60598-1 and BS 4533-102.1, EN 60598-2-1
Electrical Equipment (Safety) Regulations 2016
Electromagnetic Compatibility Regulations 2016
The Restriction of the Use of Certain Hazardous Substances in Electrical and Electronic Equipment Regulations 2012
The Ecodesign for Energy-Related Products

Australia/New Zealand:
AS/NZS 60598.1 and AS/NZS 60598.2.1

26% rabatt ska dras av på angivna priser

TOP PENDANT LAMP / Ø 21 CM / 8.3"

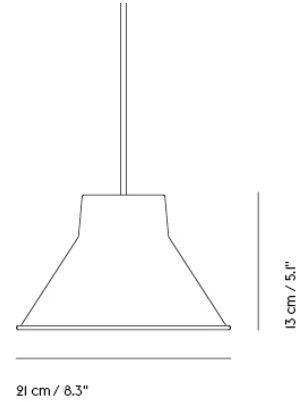

Shipper Colli	1
Gross Weight (kg)	1.54
Net Weight (kg)	0.82
Bulb included	Yes
Warranty Period	5 Years

Item No.	Color	Contract Price	Lead Time
Ready-To-Ship			
22868	Dark Green	SEK 1.504,10	-
22867	Deep Red	SEK 1.504,10	-
22865	Grey	SEK 1.504,10	-
22866	Sand	SEK 1.504,10	-

26% rabatt ska dras av på angivna priser

TOP PENDANT LAMP / Ø 28 CM / 11"

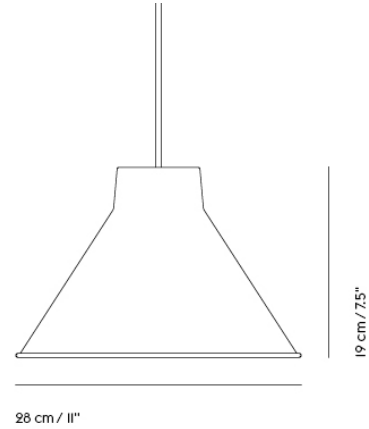

Shipper Colli	1
Gross Weight (kg)	2.13
Net Weight (kg)	1.09
Bulb included	Yes
Warranty Period	5 Years

Item No.	Color	Contract Price	Lead Time
Ready-To-Ship			
22863	Dark Green	SEK 2.317,70	-
22862	Deep Red	SEK 2.317,70	-
22860	Grey	SEK 2.317,70	-
22861	Sand	SEK 2.317,70	-

26% rabatt ska dras av på angivna priser

TOP PENDANT LAMP / Ø 36 CM / 14.2"

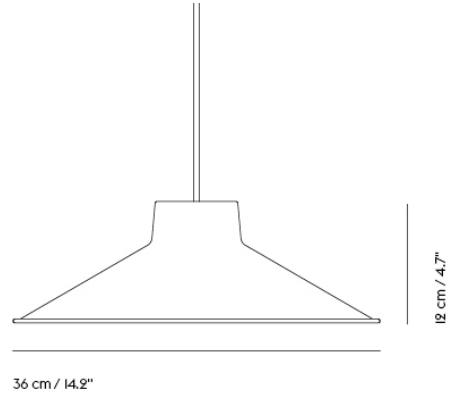

Shipper Colli	1
Gross Weight (kg)	2.68
Net Weight (kg)	1.3
Bulb included	Yes
Warranty Period	5 Years

Item No.	Color	Contract Price	Lead Time
Ready-To-Ship			
22858	Dark Green	SEK 2.106,10	-
22857	Deep Red	SEK 2.106,10	-
22855	Grey	SEK 2.106,10	-
22856	Sand	SEK 2.106,10	-

26% rabatt ska dras av på angivna priser

TOP PENDANT LAMP / Ø 38 CM / 15"

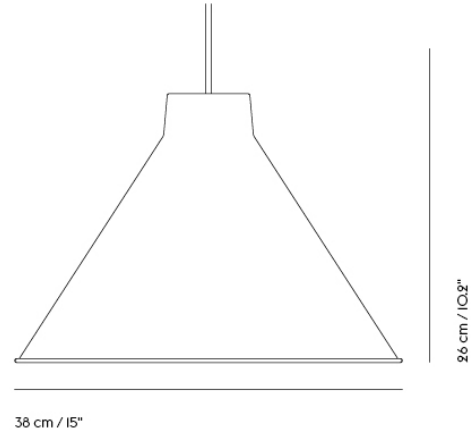

Shipper Colli	1
Gross Weight (kg)	3.32
Net Weight (kg)	1.57
Bulb included	Yes
Warranty Period	5 Years

Item No.	Color	Contract Price	Lead Time
Ready-To-Ship			
22853	Dark Green	SEK 2.880,10	-
22852	Deep Red	SEK 2.880,10	-
22850	Grey	SEK 2.880,10	-
22851	Sand	SEK 2.880,10	-

26% rabatt ska dras av på angivna priser

UNFOLD PENDANT LAMP

“We wanted to bring a new perspective to the classic industrial light with the Unfold Pendant Lamp, creating an expression that is at once timeless and modern. To achieve this, the design comes in a rubber silicone material for a playful and tactile character along with a matte touch. With its modern and flexible material, the Unfold Pendant Lamp can be folded into a flat box for eco-friendly shipping and a contemporary look.”

— Form Us With Love



Designed by	Form Us With Love
Environment	Indoor
Country of Production	China
Cord Length	260 cm / 141.5"
Light Source Included	No
Dimmable Function	Yes - if dimmable bulb is used
Socket Size	E27
Ceiling Cap Included	Yes
Description	A quirky take on the industrial pendant lampshade, the Unfold Pendant Lamp useful in any home or professional space. Made of soft silicone rubber, the pendant is available in a wide range of colors to brighten any room.
Material	Shade in silicone rubber, PVC cord. Diffuser clear frosted opal acrylic material. The shade is pressed in vulcanised rubber under high temperature. Diffuser and socket holder cut by laser.
Cleaning & Care	Clean with soft dry/wet cloth. Always switch off the electricity supply before cleaning.

26% rabatt ska dras av på angivna priser

UNFOLD PENDANT LAMP

TESTS & CERTIFICATIONS

EU:

IEC 60598-1 and IEC 60598-2-1

Low Voltage Directive (LVD) - 2014/35/EU

ECO Design Directive - 245/2009/EC

ROHS Directive - 2011/65/EU amended RoHS 3 Directive 2015/863

REACH Directive - EC/1907/2006

WEEE Directive - 2012/19/EU

UK:

BS EN 60598-1 and BS 4533-102.1, EN 60598-2-1

Electrical Equipment (Safety) Regulations 2016

Electromagnetic Compatibility Regulations 2016

The Restriction of the Use of Certain Hazardous Substances in Electrical and Electronic Equipment Regulations 2012

The Ecodesign for Energy-Related Products and Energy Information (Amendment) (EU Exit) Regulations 2019

USA/Canada:

UL STD. 1598 / CSA STD. C22.2 NO.250.0

Australia/New Zealand:

AS/NZS 60598.1 and AS/NZS 60598.2.1

The Eurasian Economic Union:

TP TC 004 and TP TC 020

China:

GB 7000.201 and GB 7000.1

26% rabatt ska dras av på angivna priser

UNFOLD PENDANT LAMP

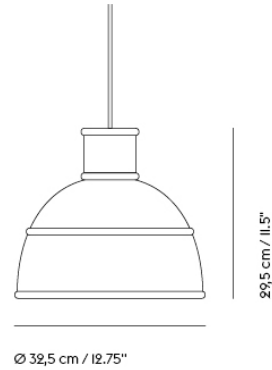

Shipper Colli	1
Gross Weight (kg)	1.8
Net Weight (kg)	1.26
Bulb included	
Warranty Period	5 years

Item No.	Color	Contract Price	Lead Time
Ready-To-Ship			
14210	Beige-Rose	SEK 1.848,10	-
14201	Black	SEK 1.848,10	-
14200	Dark Grey	SEK 1.848,10	-
14206	Dusty Red ***	SEK 1.848,10	-
14204	Green	SEK 1.848,10	-
14203	Light Grey	SEK 1.848,10	-
14208	Mustard	SEK 1.848,10	-
14211	Olive	SEK 1.848,10	-
14205	Orange	SEK 1.848,10	-
14209	Terracotta	SEK 1.848,10	-
14207	White	SEK 1.848,10	-
14202	Yellow ***	SEK 1.848,10	-
Extras			
12292	Unfold / E27 Cord - Beige-Rose (per linear meter)	SEK 26,00	-
12285	Unfold / E27 Cord - Black (per linear meter)	SEK 26,00	-
12280	Unfold / E27 Cord - Dark Grey (per linear meter)	SEK 26,00	-
12288	Unfold / E27 Cord - Light Grey (per linear meter)	SEK 26,00	-
12290	Unfold / E27 Cord - Mustard (per linear meter)	SEK 26,00	-
12293	Unfold / E27 Cord - Olive (per linear meter)	SEK 26,00	-
12281	Unfold / E27 Cord - White (per linear meter)	SEK 26,00	-
12298	Unfold Cord - Green (per linear meter)	SEK 26,00	-

26% rabatt ska dras av på angivna priser

Item No.	Color	Contract Price	Lead Time
12299	Unfold Cord - Dusty Red (per linear meter)	SEK 26,00	-
12289	Unfold Cord - Orange (per linear meter) ***	SEK 26,00	-
12291	Unfold Cord - Terracotta (per linear meter)	SEK 26,00	-
12282	Unfold Cord - Yellow (per linear meter) ***	SEK 26,00	-
24050	Ceiling Cap - White	SEK 116,10	-

26% rabatt ska dras av på angivna priser

UNDER THE BELL PENDANT LAMP

"Under The Bell is more than just a lampshade—when situated over a table or in an open space, the bell-shaped light creates its own space within the environment. As such, the design embraces and shelters the people underneath, both in a physical and abstract manner, for an intimate atmosphere. The design is made using fibers from recycled plastic bottles that, along with its unique shape, enables Under The Bell to absorb sound and improve the acoustics of any room."

— Iskos-Berlin



Design by	Iskos-Berlin
Environment	Indoor
Country of Production	Germany
Cord Length	500 cm / 197"
Light Source Included	No
Dimmable Function	Yes - if dimmable bulb is used
Socket Size	E27
Ceiling Cap Included	Yes
Description	Designed in a material that uses up to 41% fibers from recycled plastic bottles, the Under The Bell Pendant Lamp not only brings a tactile and modern expression to any space but also impacts the acoustics of a room through its soft shade, paired with its graphic lines and subtle color palette.
Material	Shade made using up to 41% fibers from recycled plastic bottles. Rubber cord.
Cleaning & Care	Vacuum to remove dust. Clean off any marks with a clean moist cloth. Always switch off the electricity supply before cleaning.

26% rabatt ska dras av på angivna priser

UNDER THE BELL PENDANT LAMP

TESTS & CERTIFICATIONS

EU:

IEC 60598-1 and IEC 60598-2-1

Low Voltage Directive (LVD) - 2014/35/EU

ECO Design Directive - 245/2009/EC

ROHS Directive - 2011/65/EU amended RoHS 3 Directive 2015/863

REACH Directive - EC/1907/2006

WEEE Directive - 2012/19/EU

UK:

BS EN 60598-1 and BS 4533-102.1, EN 60598-2-1

Electrical Equipment (Safety) Regulations 2016

Electromagnetic Compatibility Regulations 2016

The Restriction of the Use of Certain Hazardous Substances in Electrical and Electronic Equipment Regulations 2012

The Ecodesign for Energy-Related Products and Energy Information (Amendment) (EU Exit) Regulations 2019

USA/Canada:

UL STD. 1598 / CSA STD. C22.2 NO.250.0

Australia/New Zealand:

AS/NZS 60598.1 and AS/NZS 60598.2.1

The Eurasian Economic Union:

TP TC 004 and TP TC 020

China:

GB 7000.201 and GB 7000.1

26% rabatt ska dras av på angivna priser

UNDER THE BELL PENDANT LAMP / Ø 55 CM / 21.7"

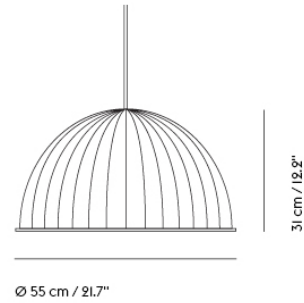

Shipper Colli	1
Gross Weight (kg)	2.35
Net Weight (kg)	1.15
Bulb included	
Warranty Period	5 years

Item No.	Color	Contract Price	Lead Time
Ready-To-Ship			
21361	Black	SEK 4.639,70	-
21364	Dark Green	SEK 4.639,70	-
21362	Grey	SEK 4.639,70	-
21363	White Mélange	SEK 4.639,70	-
Extras			
60362	Under the Bell Cord - Black (per linear meter)	SEK 27,00	-
60364	Under the Bell Cord - Dark Green (per linear meter)	SEK 27,00	-
60363	Under the Bell Cord - Grey (per linear meter)	SEK 27,00	-
60361	Under the Bell Cord - White Mélange (per linear meter)	SEK 27,00	-
24050	Ceiling Cap - White	SEK 116,10	-

26% rabatt ska dras av på angivna priser

UNDER THE BELL PENDANT LAMP / Ø 82 CM / 32.25"

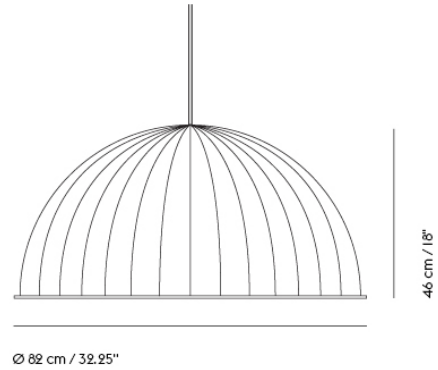

Shipper Colli	1
Gross Weight (kg)	4.95
Net Weight (kg)	2.35
Bulb included	
Warranty Period	5 years

Item No.	Color	Contract Price	Lead Time
Ready-To-Ship			
21351	Black	SEK 5.804,10	-
21354	Dark Green	SEK 5.804,10	-
21352	Grey	SEK 5.804,10	-
21353	White Mélange	SEK 5.804,10	-
Extras			
60362	Under the Bell Cord - Black (per linear meter)	SEK 27,00	-
60364	Under the Bell Cord - Dark Green (per linear meter)	SEK 27,00	-
60363	Under the Bell Cord - Grey (per linear meter)	SEK 27,00	-
60361	Under the Bell Cord - White Mélange (per linear meter)	SEK 27,00	-
24050	Ceiling Cap - White	SEK 116,10	-

26% rabatt ska dras av på angivna priser

COLOR CODE INDEX

PRODUCT

Ambit Pendant Ø16,5 - Black

Ambit Pendant Ø16,5 - Dusty Green

Ambit Pendant Ø16,5 - Grey

Ambit Pendant Ø16,5 - Light Blue

Ambit Pendant Ø16,5 - Taupe

Ambit Pendant Ø16,5 - White

Ambit Pendant Ø25 - Black

Ambit Pendant Ø25 - Dusty Green

Ambit Pendant Ø25 - Grey

Ambit Pendant Ø25 - Light Blue

Ambit Pendant Ø25 - Taupe

Ambit Pendant Ø25 - White

Ambit Pendant Ø40 - Black

Ambit Pendant Ø40 - Dusty Green

Ambit Pendant Ø40 - Grey

Ambit Pendant Ø40 - Light Blue

Ambit Pendant Ø40 - Rose - DISC. WHEN OOS

Ambit Pendant Ø40 - Taupe

Ambit Pendant Ø40 - White

Ambit Pendant Ø55 - Black

Ambit Pendant Ø55 - Dusty Green

Ambit Pendant Ø55 - Grey

Ambit Pendant Ø55 - Light Blue

Ambit Pendant Ø55 - Taupe

Ambit Pendant Ø55 - White

Ambit Rail - Black

Ambit Rail - Dusty Green

Ambit Rail - Grey

Ambit Rail - Taupe

Ambit Rail - White

Ambit Wall Lamp L37 - Black

Ambit Wall Lamp L37 - Grey

Ambit Wall Lamp L37 - Taupe

Ambit Wall Lamp L37 - White

Calm Wall Lamp Ø50/19.6" - Touch Dim - Black

Calm Wall Lamp Ø50/19.6" - Touch Dim - Grey

Calm Wall Lamp Ø50/19.6" - Touch Dim - Orange

Calm Wall Lamp Ø50/19.6" - Wall Dim - Black

Calm Wall Lamp Ø50/19.6" - Wall Dim - Grey

Calm Wall Lamp Ø50/19.6" - Wall Dim - Orange

Calm Wall Lamp Ø68/26.8" - Wall Dim - Black

Calm Wall Lamp Ø68/26.8" - Wall Dim - Grey

Calm Wall Lamp Ø68/26.8" - Wall Dim - Orange

Calm Wall Lamp Ø90/35.4" - Wall Dim - Black

Calm Wall Lamp Ø90/35.4" - Wall Dim - Grey

Calm Wall Lamp Ø90/35.4" - Wall Dim - Orange

Control Lamp - Black

Control Lamp - Grey

Control Lamp - Red

Control Lamp - White

Dedicate Table Lamp L2 - Black

Dedicate Table Lamp L2 - Brown Green

Dedicate Table Lamp L2 w. Clamp - Black

Dedicate Table Lamp L2 w. Clamp - Brown Green

Dedicate Table Lamp L2 w. Pin - Black

Dedicate Table Lamp L2 w. Pin - Brown Green

Dedicate Table Lamp S1 - Black

Dedicate Table Lamp S1 - Brown Green

Dedicate Table Lamp S1 w. Clamp - Black

Dedicate Table Lamp S1 w. Clamp - Brown Green

Dedicate Table Lamp S1 w. Pin - Black

Dedicate Table Lamp S1 w. Pin - Brown Green

Dedicate Table Lamp S2 - Black

Dedicate Table Lamp S2 - Brown Green

COLOR CODES

EXTERIOR: Black (RAL 7021), INTERIOR: White (RAL 9016)

EXTERIOR: Dusty Green (RAL 140 60 IO), INTERIOR: White (RAL 9016)

EXTERIOR: Grey (RAL 7040), INTERIOR: White (RAL 9016)

EXTERIOR: Light Blue (NCS 1515-R80B), INTERIOR (RAL 9016)

EXTERIOR: Taupe (NCS S 6005-Y50R), INTERIOR: White (RAL 9016)

EXTERIOR: White (RAL 9016), INTERIOR: White (RAL 9016)

EXTERIOR: Black (RAL 7021), INTERIOR: White (RAL 9016)

EXTERIOR: Dusty Green (RAL 140 60 IO), INTERIOR: White (RAL 9016)

EXTERIOR: Grey (RAL 7040), INTERIOR: White (RAL 9016)

EXTERIOR: Light Blue (NCS 1515-R80B), INTERIOR (RAL 9016)

EXTERIOR: Taupe (NCS S 6005-Y50R), INTERIOR: White (RAL 9016)

EXTERIOR: White (RAL 9016), INTERIOR: White (RAL 9016)

Black (RAL 7021)

EXTERIOR: Pantone 5635 C, NCS S 4010-G10Y, INTERIOR: NCS S 0300-N

EXTERIOR: Grey (RAL 7040), INTERIOR: White (RAL 9016)

EXTERIOR: Light Blue (NCS 1515-R80B), INTERIOR (RAL 9016)

EXTERIOR: Rose (RAL O40 80 IO), INTERIOR: White (RAL 9016)

EXTERIOR: Taupe (NCS S 6005-Y50R), INTERIOR: White (RAL 9016)

EXTERIOR: White (RAL 9016), INTERIOR: White (RAL 9016)

EXTERIOR: Black (RAL 7021), INTERIOR: White (RAL 9016)

EXTERIOR: Dusty Green (RAL 140 60 IO), INTERIOR: White (RAL 9016)

EXTERIOR: Grey (RAL 7040), INTERIOR: White (RAL 9016)

EXTERIOR: Light Blue (NCS 1515-R80B), INTERIOR (RAL 9016)

EXTERIOR: Taupe (NCS S 6005-Y50R), INTERIOR: White (RAL 9016)

EXTERIOR: White (RAL 9016), INTERIOR: White (RAL 9016)

EXTERIOR: Black (RAL 7021), INTERIOR: White (RAL 9016)

EXTERIOR: Dusty Green (RAL 140 60 IO), INTERIOR: White (RAL 9016)

EXTERIOR: Grey (RAL 7040), INTERIOR: White (RAL 9016)

EXTERIOR: Taupe (NCS S 6005-Y50R), INTERIOR: White (RAL 9016)

RAL 9016

EXTERIOR: Black (RAL 7021), INTERIOR: White (RAL 9016)

EXTERIOR: Grey (RAL 7040), INTERIOR: White (RAL 9016)

EXTERIOR: Taupe (NCS S 6005-Y50R), INTERIOR: White (RAL 9016)

EXTERIOR: White (RAL 9016), INTERIOR: White (RAL 9016)

PROFILE: RAL 9016, SILICONE BAND: RAL 9017, CABLE W. PLUG: RAL 9016

PROFILE: RAL 9016, SILICONE BAND: RAL 7044, CABLE W. PLUG: RAL 9016

PROFILE: RAL 9016, SILICONE BAND: RAL 2000, CABLE W. PLUG: RAL 9016

PROFILE: RAL 9016, SILICONE BAND: 9017

PROFILE: 9016, SILICONE BAND: 7044

PROFILE: 9016, SILICONE BAND: 2000

PROFILE: RAL 9016, SILICONE BAND: 9017

PROFILE: 9016, SILICONE BAND: 7044

PROFILE: RAL 9016, SILICONE BAND: 2000

PROFILE: 9016, SILICONE BAND: 7044

PROFILE: 9016, SILICONE BAND: 2000

Black

Grey (Pantone 7534 C)

Red (Pantone 7619 C)

White (RAL 9016)

RAL 9016

NCS S 6030-G90Y

RAL 9016

NCS S 6030-G90Y

RAL 9016

NCS S 6030-G90Y

RAL 9016

NCS S 6030-G90Y

RAL 9016

NCS S 6030-G90Y

RAL 9016

NCS S 6030-G90Y

RAL 9016

NCS S 6030-G90Y

NEAREST MATCH

EXTERIOR: Pantone 426 C, NCS 8505-R80B, INTERIOR: NCS S 0300-N

EXTERIOR: Pantone 5635 C, NCS S 4010-G10Y, INTERIOR: NCS S 0300-N

EXTERIOR: Pantone Cool Grey 7C, NCS 4005-R80B, INTERIOR: NCS S 0300-N

EXTERIOR: Pantone 537 C, RAL Design 260 80 IO, INTERIOR: NCS S 0300-N

EXTERIOR: Pantone Warm grey IO, RAL Classic 7006

EXTERIOR: Pantone 426 C, NCS 8505-R80B, INTERIOR: NCS S 0300-N

EXTERIOR: Pantone 426 C, NCS 8505-R80B, INTERIOR: NCS S 0300-N

EXTERIOR: Pantone 5635 C, NCS S 4010-G10Y, INTERIOR: NCS S 0300-N

EXTERIOR: Pantone Cool Grey 7C, NCS 4005-R80B, INTERIOR: NCS S 0300-N

EXTERIOR: Pantone 537 C, RAL Design 260 80 IO, INTERIOR: NCS S 0300-N

EXTERIOR: Pantone Warm grey IO, RAL Classic 7006

EXTERIOR: Pantone 426 C, NCS 8505-R80B, INTERIOR: NCS S 0300-N

Pantone 426 C, NCS 8505-R80B

EXTERIOR: Dusty Green (RAL 140 60 IO), INTERIOR: White (RAL 9016)

EXTERIOR: Pantone Cool Grey 7C, NCS 4005-R80B, INTERIOR: NCS S 0300-N

EXTERIOR: Pantone 537 C, RAL Design 260 80 IO, INTERIOR: NCS S 0300-N

EXTERIOR: Pantone 7611 C, NCS S 1510-R, INTERIOR: NCS S 0300-N

EXTERIOR: Pantone Warm grey IO, RAL Classic 7006

EXTERIOR: Pantone 426 C, NCS 8505-R80B, INTERIOR: NCS S 0300-N

EXTERIOR: Pantone 426 C, NCS 8505-R80B, INTERIOR: NCS S 0300-N

EXTERIOR: Pantone 5635 C, NCS S 4010-G10Y, INTERIOR: NCS S 0300-N

EXTERIOR: Pantone Cool Grey 7C, NCS 4005-R80B, INTERIOR: NCS S 0300-N

EXTERIOR: Pantone 537 C, RAL Design 260 80 IO, INTERIOR: NCS S 0300-N

EXTERIOR: Pantone Warm grey IO, RAL Classic 7006

EXTERIOR: Pantone 426 C, NCS 8505-R80B, INTERIOR: NCS S 0300-N

EXTERIOR: Pantone 426 C, NCS 8505-R80B, INTERIOR: NCS S 0300-N

EXTERIOR: Pantone 5635 C, NCS S 4010-G10Y, INTERIOR: NCS S 0300-N

EXTERIOR: Pantone Cool Grey 7C, NCS 4005-R80B, INTERIOR: NCS S 0300-N

EXTERIOR: Pantone Warm grey IO, RAL Classic 7006

EXTERIOR: Pantone 426 C, NCS 8505-R80B, INTERIOR: NCS S 0300-N

EXTERIOR: Pantone 426 C, NCS 8505-R80B, INTERIOR: NCS S 0300-N

EXTERIOR: Pantone Cool Grey 7C, NCS 4005-R80B, INTERIOR: NCS S 0300-N

EXTERIOR: Taupe (NCS S 6005-Y50R), INTERIOR: White (RAL 9016)

EXTERIOR: White (RAL 9016), INTERIOR: White (RAL 9016)

-

-

-

-

-

-

-

-

-

-

-

-

(close to RAL 7021)

RAL Design 090 80 IO, NCS S 1505-G90Y

RAL Design 040 50 60

NCS S 0300-N

-

-

-

-

-

-

-

-

-

-

-

-

-

-

-

-

-

-

-

-

-

-

-

-

PRODUCT

Tip Table Lamp - Copper Brown
 Tip Table Lamp - Grey
 Tip Table Lamp - White
 Tip Wall Lamp - Black
 Tip Wall Lamp - Copper Brown
 Tip Wall Lamp - Grey
 Tip Wall Lamp - White
 Top Pendant Lamp - Ø21 - Dark Green - EU
 Top Pendant Lamp - Ø21 - Deep Red - EU
 Top Pendant Lamp - Ø21 - Grey - EU
 Top Pendant Lamp - Ø21 - Sand - EU
 Top Pendant Lamp - Ø28 - Dark Green - EU
 Top Pendant Lamp - Ø28 - Deep Red - EU
 Top Pendant Lamp - Ø28 - Grey - EU
 Top Pendant Lamp - Ø28 - Sand - EU
 Top Pendant Lamp - Ø36 - Dark Green - EU
 Top Pendant Lamp - Ø36 - Deep Red - EU
 Top Pendant Lamp - Ø36 - Grey - EU
 Top Pendant Lamp - Ø36 - Sand - EU
 Top Pendant Lamp - Ø38 - Dark Green - EU
 Top Pendant Lamp - Ø38 - Deep Red - EU
 Top Pendant Lamp - Ø38 - Grey - EU
 Top Pendant Lamp - Ø38 - Sand - EU
 Unfold - Beige-Rose
 Unfold - Black
 Unfold - Dark Grey
 Unfold - Dusty Red
 Unfold - Green
 Unfold - Light Grey
 Unfold - Mustard
 Unfold - Olive
 Unfold - Orange
 Unfold - Terracotta
 Unfold - White
 Unfold - Yellow

COLOR CODES

Copper Brown (RAL 8004)
 RAL 7044
 White (RAL 9016)
 RAL 9011
 RAL 8004
 RAL 7044
 RAL 9016
 NCS S 8505-G2OY
 RAL 8015
 RAL 7044
 NCS S 2010-Y3OR
 NCS S 8505-G2OY
 RAL 8015
 RAL 7044
 NCS S 2010-Y3OR
 NCS S 8505-G2OY
 RAL 8015
 RAL 7044
 NCS S 2010-Y3OR
 NCS S 8505-G2OY
 RAL 8015
 RAL 7044
 NCS S 2010-Y3OR
 Pantone 7590 C
 Pantone 426 U
 Pantone Cool Grey II U
 Pantone 7621 C
 Pantone 5625 C
 Pantone Cool Grey 4 C
 Pantone 1245 C
 RAL 7002
 Pantone 1655
 Pantone 7607C
 RAL 9016
 Pantone Yellow C

NEAREST MATCH

Pantone 1685 C, NCS S 5040-Y6OR
 -
 NCS S 0500-N
 Pantone 426 C, RAL Design 000 15 00
 Pantone 1685 C, NCS S 5040-Y6OR
 -
 NCS S 0500-N
 RAL 140 20 05, Pantone Black 3 C
 NCS S 7020-Y8OR, Pantone 4695 C
 NCS S 2502-Y, Pantone 413 C
 RAL 075 80 20, Pantone 2310 C
 RAL 140 20 05, Pantone Black 3 C
 NCS S 7020-Y8OR, Pantone 4695 C
 NCS S 2502-Y, Pantone 413 C
 RAL 075 80 20, Pantone 2310 C
 RAL 140 20 05, Pantone Black 3 C
 NCS S 7020-Y8OR, Pantone 4695 C
 NCS S 2502-Y, Pantone 413 C
 RAL 075 80 20, Pantone 2310 C
 RAL 1001, NCS S 2010-Y5OR
 RAL Design 000 15 00, NCS S 9000-N
 RAL Classic 7037, NCS S 5005-R80 B
 RAL Design 030 40 60, NCS- 2070-Y9OR
 RAL Design 150 50 10, NCS S 5010-G1OY
 RAL Design 000 75 00, NCS S 2500-N
 RAL 1005, NCS S 2060-Y1OR
 Pantone 7497 C, NCS S 5010-G9OY
 RAL Classic 2004, NCS S 0585-Y7OR
 NCS S 3040-Y8OR
 NCS S 0300-N
 RAL Design 090 80 90, NCS S 0570-G9OY

26% rabatt ska dras av på angivna priser

TEXTILE OPTIONS

Striving to work with the best suppliers, the textiles used for Muuto products are by four different companies: Danish Kvadrat and Swedish Nevotex along with both Arve from Italy and Rohlede from Germany—all suppliers that have been selected on the basis of their extensive knowledge within the field and state-of-the-art material qualities.

*Upholstered Muuto products that have the Declare Living Building Challenge Compliant certification only have the certification when upholstered with the following Kvadrat textiles: Canvas, Clara, Divina, Divina MD, Divina Mélange, Fiord, Hallingdal, Remix, Steelcut, Steelcut Trio and Vidar.



ACCA BY KVADRAT

Designer: Sahco Upholstery.

Composition: 35% viscose, 33% recycled cotton, 25% recycled polyester, 7% recycled polyacrylic.

Durability: 50.000 Martindale / Lightfastness 5-6 (ISO I-8).

Sustainability: Recycled content. Complies with Greenguard Gold Certification.

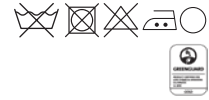

101



121

141

191

201

231

361

381

531

621

731

961



BALDER BY KVADRAT

Designer: Fanny Aronsen.

Composition: 68% new wool, 26% cotton, 6% nylon.

Durability: 100.000 Martindale / Lightfastness 6.

Sustainability: Natural fibres / Sustainable resource. Complies with Greenguard Gold Certification.

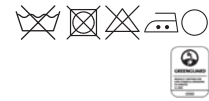

132

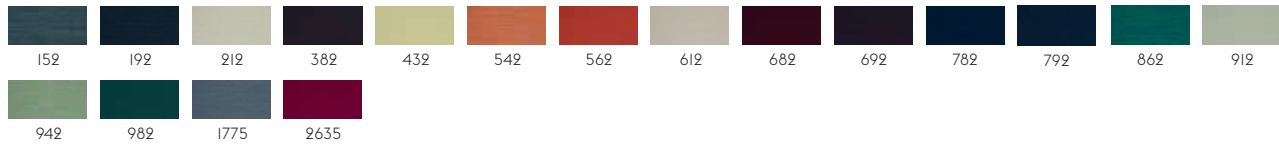

152

192

212

382

432

542

562

612

682

692

782

792

862

912

942

982

1775

2635



BECK BY MAHARAM

Composition: 78% wool, 22% nylon.

Durability: 100.000 Martindale / Lightfastness AATCC 16.3, 40+ hours.

Sustainability: Complies with Greenguard Gold Certification.

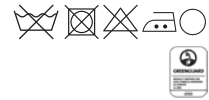

001

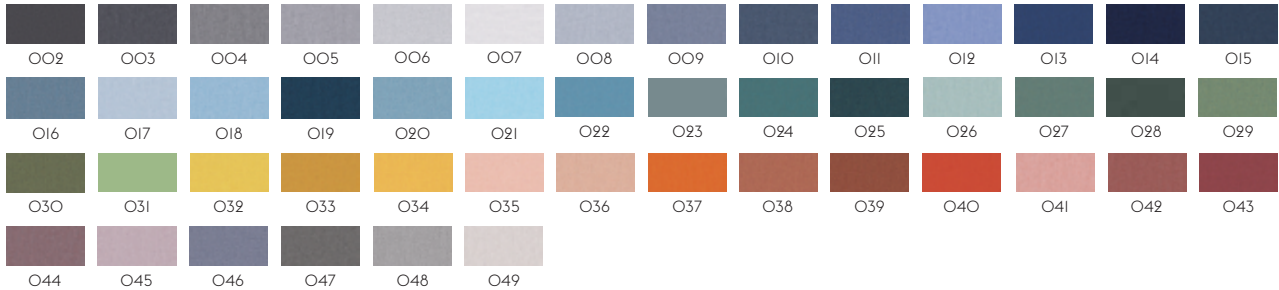

002

003

004

005

006

007

008

009

010

011

012

013

014

015

016

017

018

019

020

021

022

023

024

025

026

027

028

029

030

031

032

033

034

035

036

037

038

039

040

041

042

043

044

045

046

047

048

049



CANVAS BY KVADRAT

Designer: Giulio Ridolfo.

Composition: 90% new wool worsted, 10% nylon.

Durability: 100.000 Martindale / Lightfastness 5-7 (ISO I-8).

Sustainability: Complies with both EU ecolabel "The Flower" and Greenguard Gold Certification.

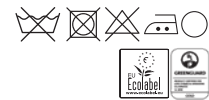

114

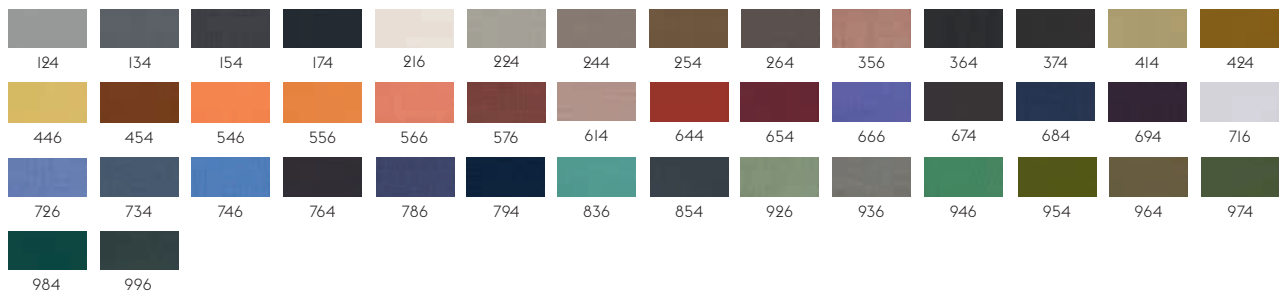

124

134

154

174

216

224

244

254

264

356

364

374

414

424

446

454

546

556

566

576

614

644

654

666

674

684

694

716

726

734

746

764

786

794

836

854

926

936

946

954

964

974

984

996

26% rabatt ska dras av på angivna priser



CLARA BY KVADRAT

Designer: Anne Birgitte Hansen.
 Composition: 92% new wool worsted.
 Durability: 80.000 Martindale.
 Sustainability: Complies with both EU ecolabel "The Flower" and Greenguard Gold Certification.

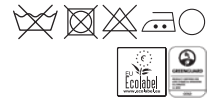

144

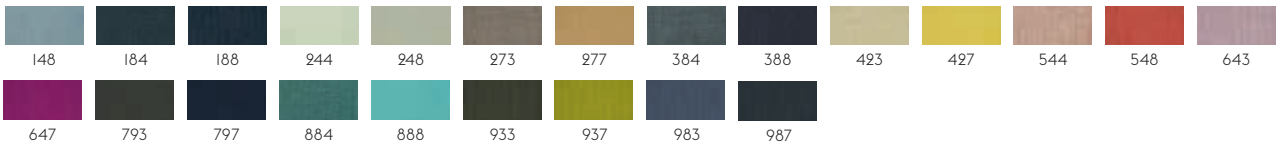

CLAY BY KVADRAT

Designer: Vincent Van Duysen for Kvadrat.
 Composition: 76% Linen, 21% Cotton, 3% Polyester.
 Durability: 45.000 Martindale / Lightfastness 4-6.
 Sustainability: Complies with Greenguard Certification.

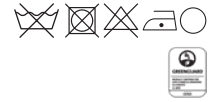

1



COLLINE BY KVADRAT

Designer: Frans Dijkmeijer
 Composition: 75% New Wool, Worsted, 17% polyacrylic, 8% Nylon
 Durability: 100.000 Martindale / Lightfastness 7
 Sustainability: Greenguard Gold, HPD, EPD

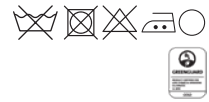

127

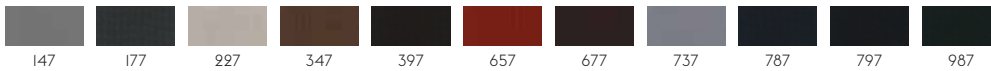

DIVINA BY KVADRAT

Designer: Finn Sködt.
 Composition: 100% new wool.
 Durability: 45.000 Martindale / Lightfastness 5-6.
 Sustainability: Complies with both EU ecolabel "The Flower" and Greenguard Gold Certification.

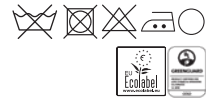

106

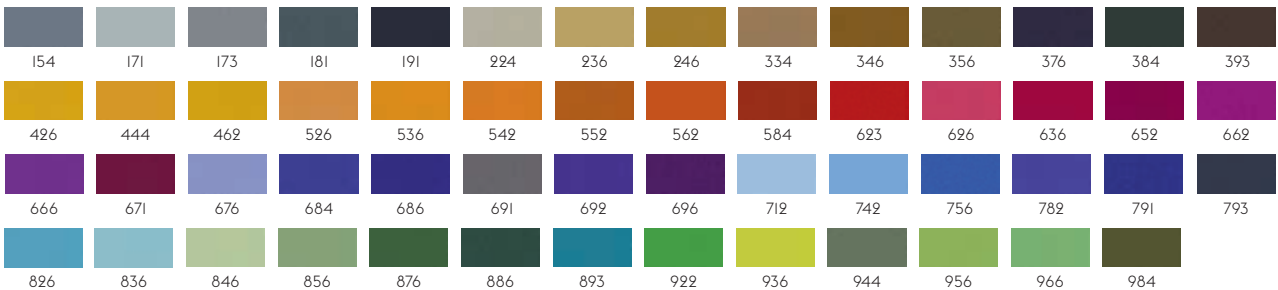

DIVINA MD BY KVADRAT

Designer: Finn Sködt.
 Composition: 100% new wool.
 Durability: 45.000 Martindale / Lightfastness 5-6 (ISO I-8).
 Sustainability: Complies with both EU ecolabel "The Flower" and Greenguard Gold Certification.

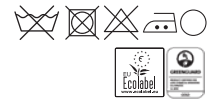

193

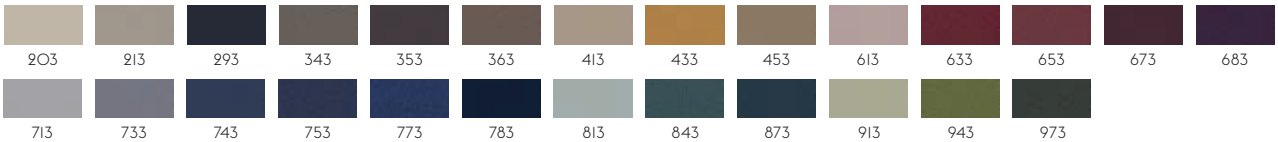

26% rabatt ska dras av på angivna priser



DIVINA MELANGE BY KVADRAT

Designer: Finn Sködt.

Composition: 100% new wool.

Durability: 45.000 Martindale / Lightfastness 6-7.

Sustainability: Complies with both EU ecolabel "The Flower" and Greenguard Gold Certification.



120

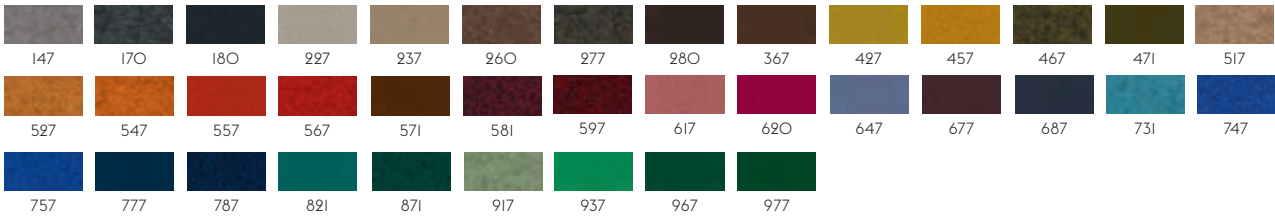

ECRITURE BY KVADRAT

Designer: Sahco.

Composition: 40% polyacrylic, 27% polyester, 18% viscose, 9% linen, 6% cotton.

Durability: 70.000 Martindale / Lightfastness 6.

Sustainability: Complies with Greenguard Gold Certification.



0100

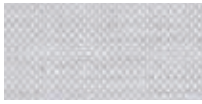
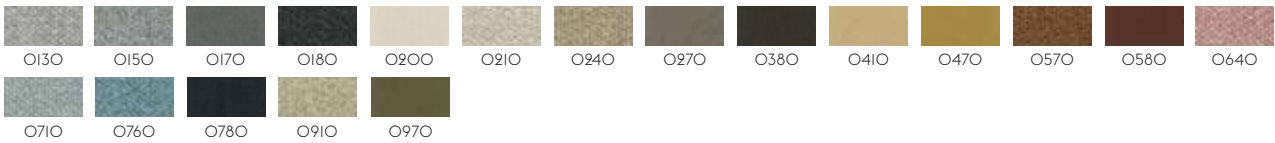

FIORD BY KVADRAT

Designer: Tone Barnung & Louise Sigvardt.

Composition: 92% new wool worsted, 8% nylon.

Durability: 60.000 Martindale / Lightfastness 5-6.

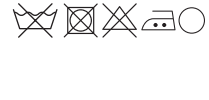

101

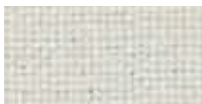
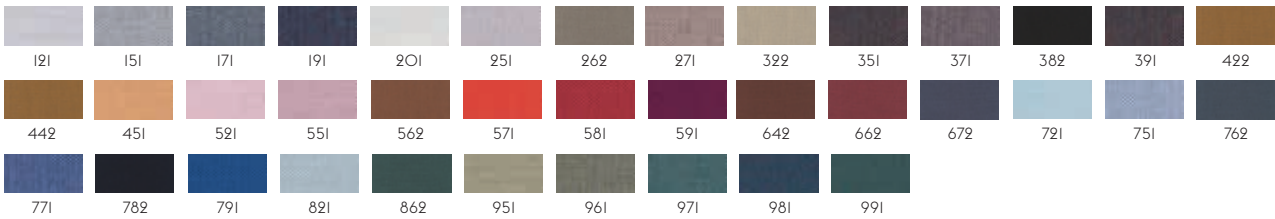

HALLINGDAL 65 BY KVADRAT

Designer: Nanna Ditzel.

Composition: 70% new wool, 30% viscose.

Durability: 100.000 Martindale / Lightfastness 6-7.

Sustainability: Complies with both EU ecolabel "The Flower" and Greenguard Gold Certification.

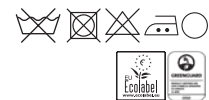

100

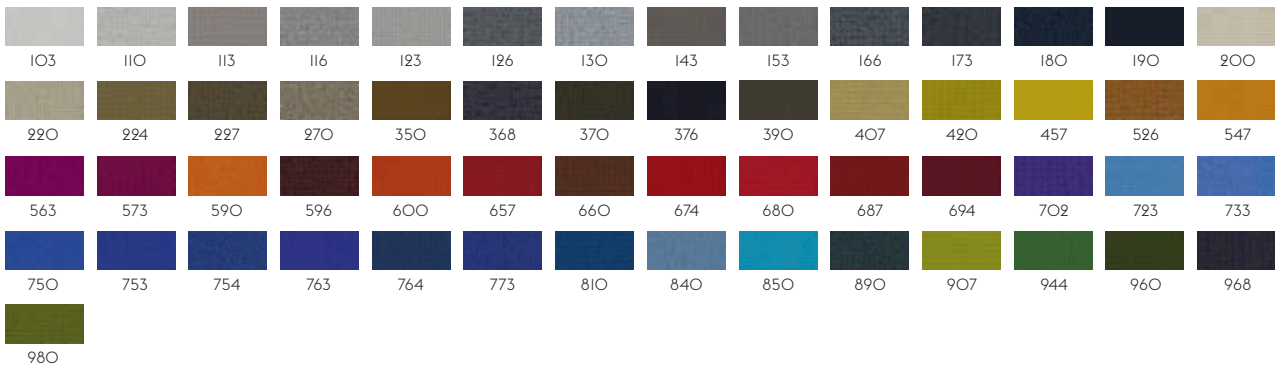

HEARTH BY MAHARAM

Composition: 32% wool, 31% acrylic, 30% cotton, 7% polyester

Durability: 60.000 Martindale / Lightfastness AATCC 16.3, 40+ hours.

Sustainability: Complies with Greenguard Gold Certification.

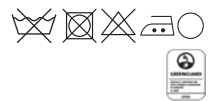

001

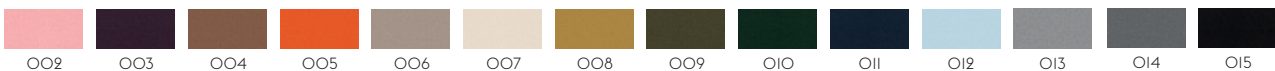

26% rabatt ska dras av på angivna priser

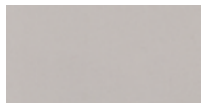

IO2

HERO BY KVADRAT

Designer: Patricia Urquiola.
Composition: 96% new wool, 4% nylon.
Durability: 45.000 Martindale / Lightfastness 5-6.
Sustainability: Complies with EU ecolabel "The Flower".

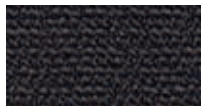
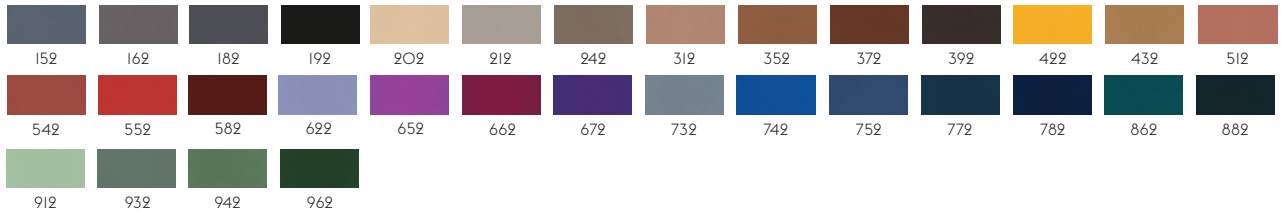
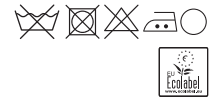

3

OCEAN BY ROHLEDER

Designer: Rohleder.
Composition: 74% Polyacrylic / 26% Polyester.
Durability: 30.000 Martindale / Lightfastness 5-7 (ISO I-8).



III

PLANUM BY KVADRAT

Designer: Raw Color.
Composition: 44% new wool, 42% polyester, 14% nylon.
Durability: 100.000 Martindale / Lightfastness 5-6 (ISO I-8).
Sustainability: Complies with Greenguard Certification.

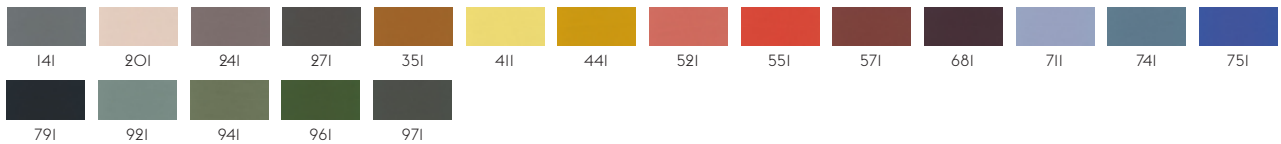
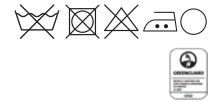

IO8

RE-WOOL BY KVADRAT

Designer: Margrethe Odgaard.
Composition: 45% new wool worsted, 45% recycled wool, 10% nylon.
Durability: 100.000 Martindale / Lightfastness 5-7 (ISO I-8).
Sustainability: Complies with both EU ecolabel "The Flower" and Greenguard Gold Certification.

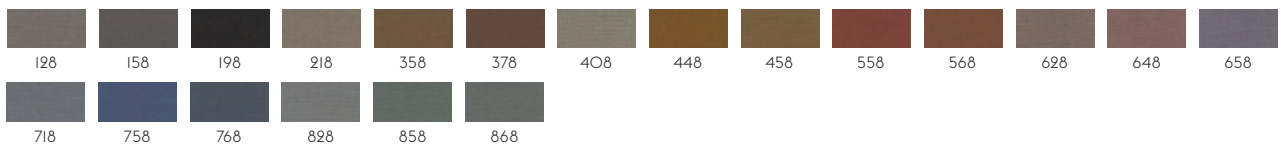
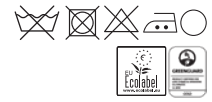

II3

REMIK BY KVADRAT

Designer: Giulio Ridolfo.
Composition: 90% new wool worsted, 10% nylon.
Durability: 100.000 Martindale / Lightfastness 5-7 (ISO I-8).
Sustainability: Complies with both EU ecolabel "The Flower" and Greenguard Gold Certification.

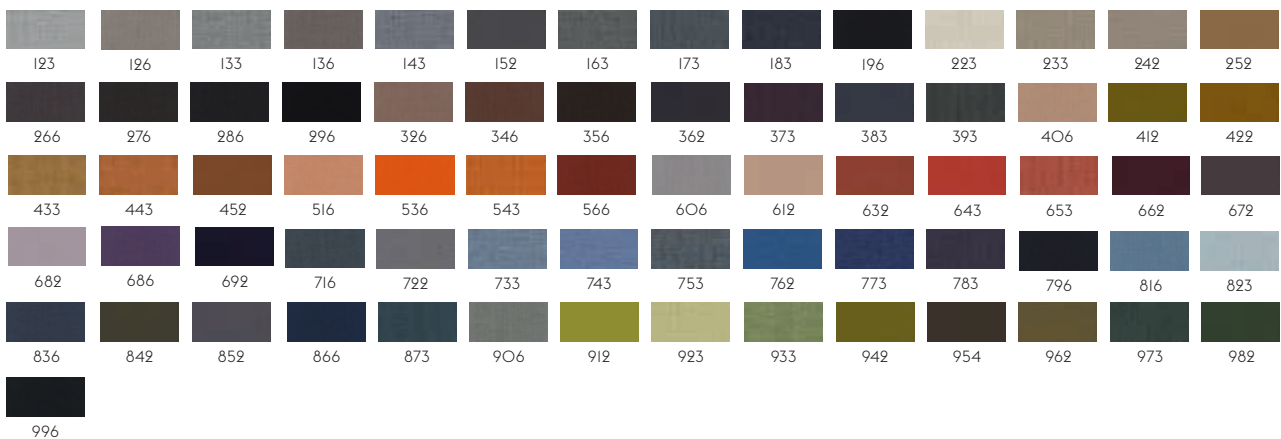
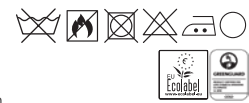

26% rabatt ska dras av på angivna priser



SABI BY KVADRAT

Designer: Louise Sigvardt
 Composition: 65% New Wool, Worsted, 23% Recycled Wool, 12% Nylon
 Durability: 80,000 Martindale / Lightfastness 5-7
 Sustainability: Greenguard Gold, HPD, EPD

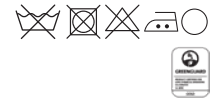

121

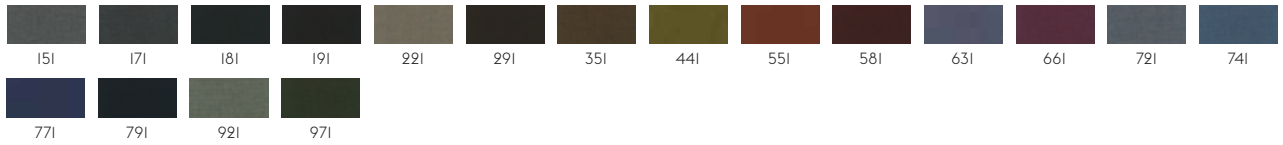

STEELCUT BY KVADRAT

Designer: Dijkmeijer & Ridolfo.
 Composition: 90% new wool worsted, 10% nylon.
 Durability: 80,000 Martindale / Lightfastness 5-7 (ISO 1-8).
 Sustainability: Complies with both EU ecolabel "The Flower" and Greenguard Gold Certification.

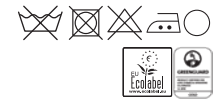

110

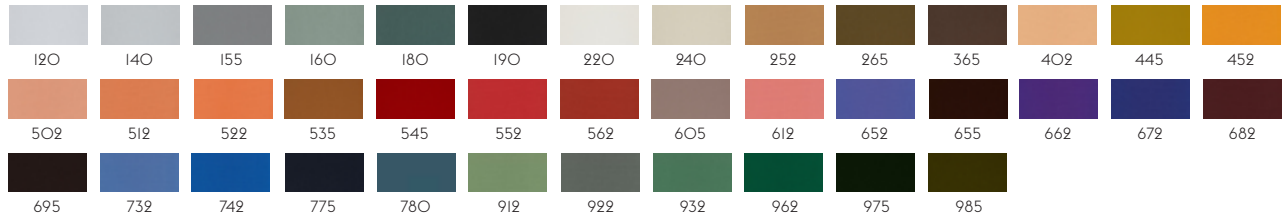

STEELCUT TRIO BY KVADRAT

Designer: Dijkmeijer & Ridolfo.
 Composition: 90% new wool worsted, 10% nylon.
 Durability: 100,000 martindale / Lightfastness 5-7 (ISO 1-8).
 Sustainability: Complies with both EU ecolabel "The Flower" and Greenguard Gold Certification.

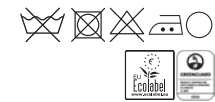

105

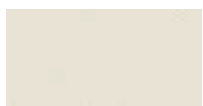
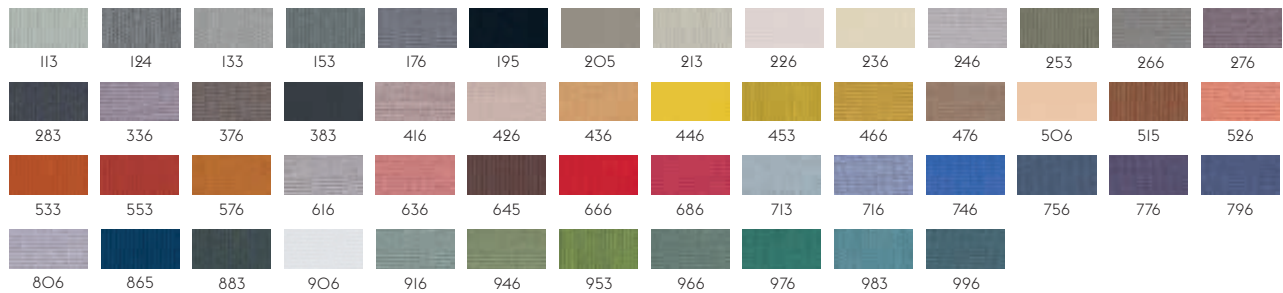

STILL BY KVADRAT

Designer: Georgina Wright.
 Composition: 100% Trevira CS.
 Durability: 50,000 Martindale / Lightfastness: 6



111

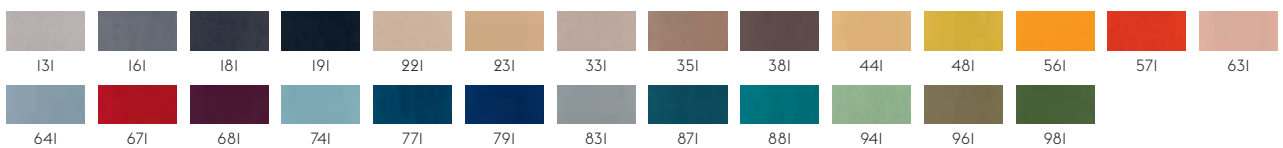

TWILL WEAVE BY KVADRAT

Designer: Jonathan Olivares.
 Composition: 90% new wool (worsted), 10% nylon.
 Durability: 60,000 Martindale / Lightfastness 5-7 (ISO 1-8).
 Sustainability: Complies with both EU ecolabel "The Flower" and Greenguard Gold Certification.

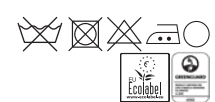

110

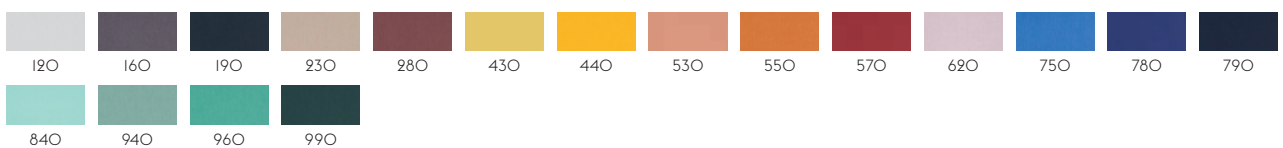

26% rabatt ska dras av på angivna priser



VANCOUVER BY ROSSINI DELLA QUERCIA
 Designer: Gabriella Zecca
 Composition: 52% cotton, 48% acrylic.
 Durability: 40.000 Martindale / Lightfastness 4-5.



4



VIDAR BY KVADRAT
 Designer: Raf Simons & Fanny Aronsen for Kvadrat.
 Composition: 94% new wool, 6% nylon.
 Durability: 100.000 Martindale / Lightfastness 6-7.
 Sustainability: Natural fibres / Sustainable resource. Complies with Greenguard Gold Certification.



106

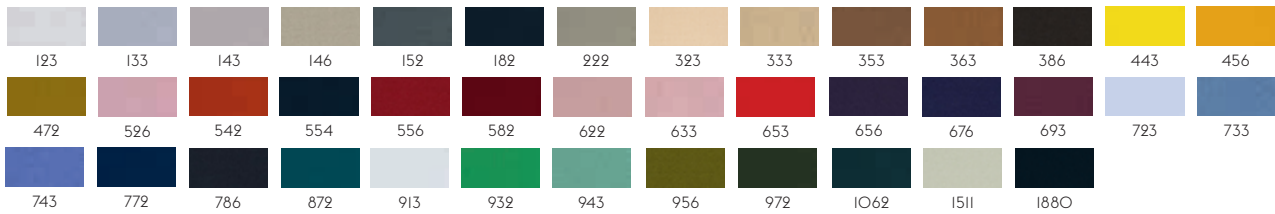

WOOLY BY NEVOTEX
 Designer: Nevotex
 Composition: 70% wool, 25% polyamide, 5% other fibres.
 Durability: 150.000 Martindale / Lightfastness 6-8.



0091

Wooly is woven in 70% recycled wool, sourced from leftover materials of clothing production and other wool products. One kilo of pure new wool generates 9 kilograms of carbon dioxide when produced while processing one kilo of recycled wool only generates 0.5 kilograms of carbon dioxide. Furthermore, recycled wool has a positive environmental impact due to lessened water consumption and lower energy consumption.



26% rabatt ska dras av på angivna priser

LEATHER OPTIONS

At Muuto, we work with some of the leading European leather suppliers to ensure that the leather used for our designs is always of the highest possible standard. Our leather options range from the Refine Leather, a modern and sleek full-grain leather with a soft touch, over Easy Leather, a lightly buffed natural grain leather with a soft and waxy feel along with a matte look, to our Endure Leather, a pliable and extremely durable semi-aniline leather ideal for hard contract environments.



ALLURE — ANILINE LEATHER

Soft nubuck aniline leather from European raw hides, known for its exclusive appeal and soft, velvety feel. The leather is dyed through, chrome tanned and produced without the use of PCP and CFC which can be damaging to the environment.

CHAL

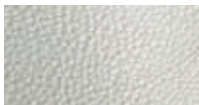

EASY LEATHER

Lightly Buffed Natural Grain Leather
Raw material: Designed and processed in Italy. The leather is dyed through, chrome tanned and finishing is with resins and pigments.

ZINC

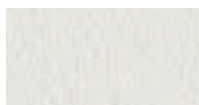
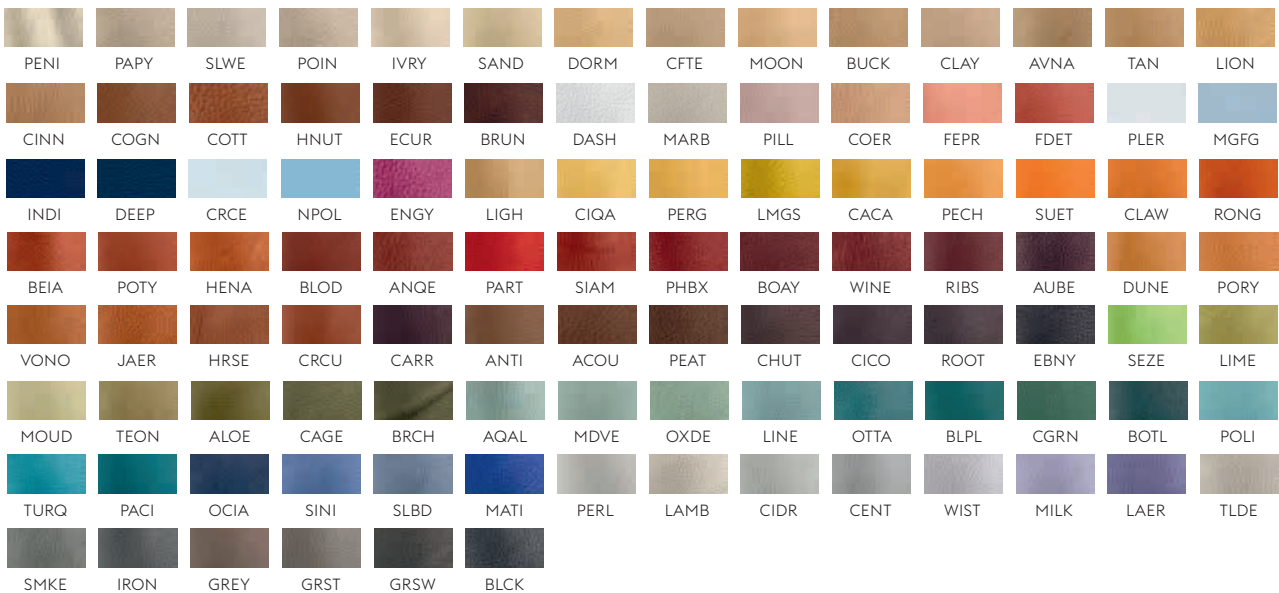

ENDURE LEATHER

Semi-aniline leather with high durability, making it ideal for contract environments.
Raw material: Leather from Scandinavian raw hides.
The leather is dyed through a chrome free tanning process. Also available in custom colors in a minimum of 1 hide.

CWIT



26% rabatt ska dras av på angivna priser



ANTH

GRACE — ANILINE LEATHER

Aniline leather from European raw hides with a natural look and velvety feel, characterized by the natural markings and imperfections that give it a distinct beauty. The leather is dyed through, tanned without chrome and produced without the use of PCP and CFC which can be damaging to the environment.



CUST

ILLUSION

Imitation leather from PU (Polyethan) is hard-wearing and easy to maintain which makes it particularly well suited to public spaces, such as restaurants, cafés and lounges. Imitation leather is also a good option for healthcare settings and public spaces where furniture and fittings require frequent and thorough cleaning.



CREM

REFINE LEATHER

Aniline Leather.
Raw material: Grain leather from European raw hides. The leather is dyed through, chrome tanned and produced without the use of PCP and CFC which can be damaging to the environment.

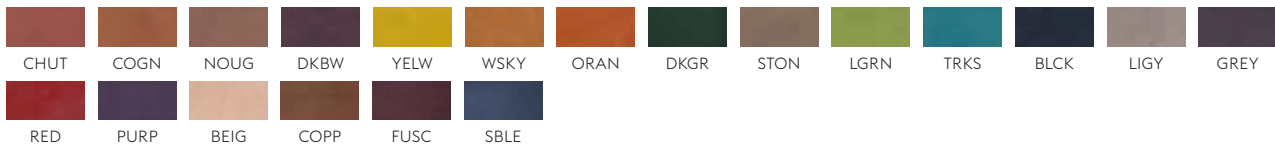

26% rabatt ska dras av på angivna priser

MATERIAL TEXTURES

At Muuto, we use an expanded breadth of materials to express our ideas of new perspectives on Scandinavian design. Working with leading suppliers across the world, we strive to use materials that embody our quality standards to provide designs that'll pass the test of time and bring a modern touch to any space at one and the same time. Explore the various textures of materials that are used throughout the Muuto universe.

WOOD



Ash



Full Colored Lacquered Oak



Lacquered MDF



Oak Veneer

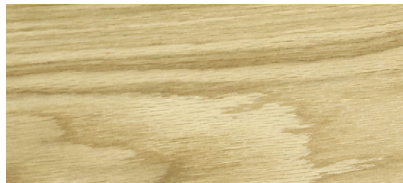

Solid Oak, Natural Oil



Solid Oak White Pigmented Oil



Oregon Pine



Stained Dark Brown Oak Veneer

STONE ACRYLIC COMPOSITE

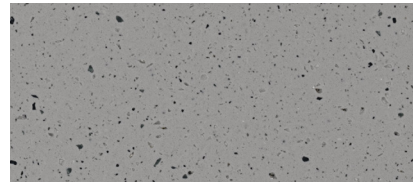

PLASTIC & WOOD COMPOSITE

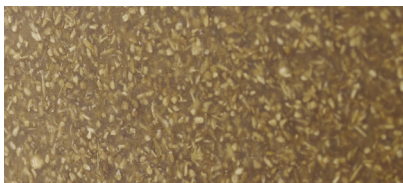

Bamboo Wood & Plastic Composite

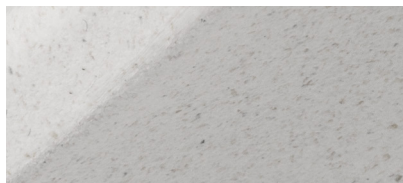

Wood & Plastic Composite

RECYCLED PLASTIC

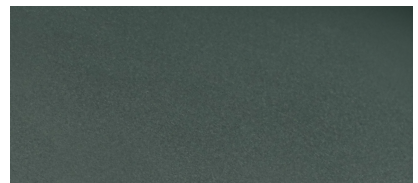

26% rabatt ska dras av på angivna priser

METAL



Anodized Aluminum



Lacquered Steel

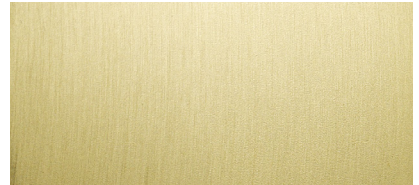

Solid Brass Aluminum



Lacquered Aluminum

POLYMER FELT

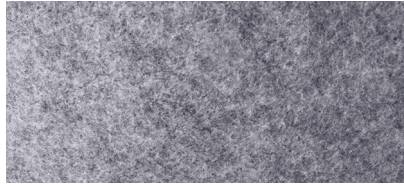

SILICONE RUBBER



LINOLEUM



LAMINATE

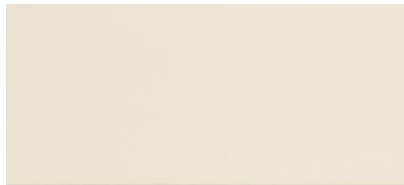

NANOLAMINATE

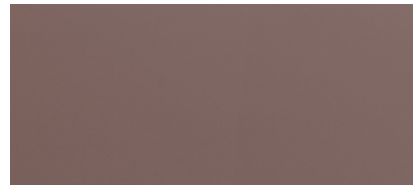

CERAMICS



CORK

