

# Statligt Ramavtal - Möbler och inredning

Delområde - Armaturer

Ramavtalsnummer 23.3-5834-2022-007

## Wästberg Lighting - Produktlista nr 1



**Kinnarps®**

17 % rabatt ska dras av på angivna priser.

## Kinnarps AB

521 88 Kinnarp  
0515 - 380 00

## Kontakt avtalsfrågor

Fredrik Ek  
0515 - 380 59

## E-postadress för avrop

avrop.kammarkollegiet@kinnarps.se

## Kinnarps Showrooms

<b>ARVIKA</b>	Blåstervägen 3 671 41 ARVIKA 0570-71 17 70	<b>KIRUNA</b>	Triangelvägen 2 981 38 KIRUNA 0980-804 00	<b>SUNDSVALL</b>	Tegelvägen 18 853 50 SUNDSVALL 060- 14 48 40
<b>BORÅS</b>	Företagsgatan 14 (Viared) 504 64 BORÅS 033-44 73 73	<b>KRISTIANSTAD</b>	Karlgatan 45 291 59 KRISTIANSTAD 044-10 10 10	<b>SÖDERTÄLJE</b>	Hantverksvägen 10 151 65 SÖDERTÄLJE 08-550 664 55
<b>FALUN</b>	Krontallsvägen 28 791 55 FALUN 0771-750 760	<b>LIDKÖPING</b>	Garpgatan 6 531 33 LIDKÖPING 0510-132 90	<b>TROLLHÄTTAN</b>	Betongvägen 11 461 38 TROLLHÄTTAN 0520-48 85 85
<b>GISLAVED</b>	Regeringsgatan 14 332 30 GISLAVED 0371-58 69 00	<b>LINKÖPING</b>	Gillbergsgatan 42 582 73 LINKÖPING 013-36 48 00	<b>UMEÅ</b>	Cementvägen 16 906 21 UMEÅ 090-18 17 00
<b>GÄVLE</b>	Södra Skeppsbron 17 802 84 GÄVLE 0771-750 760	<b>LJUNGBY</b>	Gängesvägen 6 341 31 LJUNGBY 0470-702330	<b>UPPSALA</b>	Sylveniusgatan 4 754 50 UPPSALA 018-65 17 00
<b>GÖTEBORG</b>	Ebbe Lieberathsgatan 30 412 65 GÖTEBORG 031-703 27 00	<b>LULEÅ</b>	Ödlegatan 1A 973 34 LULEÅ 0920-101 70	<b>VARBERG</b>	Norrkatan 3 432 41 VARBERG 0340-59 17 01
<b>HALMSTAD</b>	Fyllebrovägen 16 302 60 HALMSTAD 035-17 74 70	<b>LYCKSELE</b>	Umevägen 1 921 45 LYCKSELE 070 - 220 08 75	<b>VISBY</b>	Skarphällsgatan 13 621 41 VISBY 0498-657500
<b>HELSINGBORG</b>	Garnisonsgatan 22 254 66 HELSINGBORG 042-38 83 00	<b>MALMÖ</b>	Östra Hindbyvägen 63 213 74 MALMÖ 040-14 34 20	<b>VÄSTERVIK</b>	Storgatan 39 593 33 VÄSTERVIK 0490-102 00
<b>HUDIKSVALL</b>	Rönningevägen 2 824 34 HUDIKSVALL 0650-991 91	<b>MOTALA</b>	Vintergatan 8 591 32 MOTALA 0141-21 36 76	<b>VÄSTERÅS</b>	Lysgränd 3 721 30 VÄSTERÅS 021-10 82 00
<b>JÖNKÖPING</b>	Huskvarnavägen 80 554 54 JÖNKÖPING 036-36 46 00	<b>NORRKÖPING</b>	Koppargatan 24 602 23 NORRKÖPING 011-31 30 00	<b>VÄXJÖ</b>	Sandvägen 8 352 45 VÄXJÖ 0470-702330
<b>KALMAR</b>	Dagövägen 3 393 54 KALMAR 0480-880 50	<b>NYKÖPING</b>	Gumsbackevägen 12 611 38 NYKÖPING 0155-20 58 10	<b>ÖREBRO</b>	Fabriksgatan 47 702 23 ÖREBRO 010-499 80 00
<b>KARLSKRONA</b>	Järavägen 6 371 49 KARLSKRONA 0455-30 75 30	<b>SKELLEFTEÅ</b>	Anders Torg 2 931 57 SKELLEFTEÅ 0910-568 00	<b>ÖRNSKÖLDSDAL</b>	Terminalvägen 9E 891 51 ÖRNSKÖLDSDAL 0660-812 00
<b>KARLSTAD</b>	Körkarlsvägen 5 653 46 KARLSTAD 054-808900	<b>SKÖVDE</b>	Norra Aspelundsvägen 1A 541 34 SKÖVDE 0500-44 51 30	<b>ÖSTERSUND</b>	Splintvägen 3 831 72 ÖSTERSUND 063-57 11 50
<b>KINNARP</b>	Industrigatan 14 521 73 KINNARP 0515-380 00	<b>STOCKHOLM</b>	Fannys Väg 5 131 54 NACKA 08-556 910 00		

**17 % rabatt ska dras av på angivna priser.**

## w102 Chipperfield b

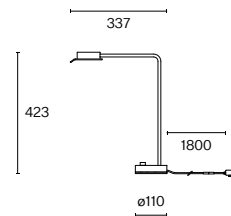

## Technical information

<b>Physical</b>	
<b>Material</b>	Shade, arm, floor stand, base, wall bracket & pin: solid brass / steel Dimmer housing: ABS
<b>Optics</b>	Diffuser & reflector: polycarbonate
<b>IP rating</b>	20
<b>Protection class</b>	III
<b>LED</b>	
<b>Light source</b>	COB LED (included)
<b>Lifetime expectancy</b>	L80 / 50,000 h
<b>CRI Colour rendering index</b>	97
<b>Stand. deviation of colour</b>	3-step MacAdam
<b>Replaceable by a professional</b>	

## Article-specific information

<b>Version</b>	
<b>Mounting</b>	
<b>LED Colour temperature (CCT) / Luminous flux</b>	
<b>Voltage / System power</b>	
<b>Light control</b>	
<b>Net weight</b>	
<b>Colour</b>	
<b>Brass</b>	●
<b>Dark steel</b>	●
<b>Brass/Dark steel</b>	●●

<b>b</b>	
<b>Base</b>	
<b>2700 K / 462 lm</b>	
<b>100–240 V / 7.5 W</b>	
<b>Integrated dimmer switch</b>	
<b>2.3 kg</b>	
<b>Art. No. / EAN code / Price VAT excluded</b>	
<b>102T100 / 7330492005003</b>	<b>7535 SEK</b>
<b>102T105 / 7330492008448</b>	<b>7535 SEK</b>

## w102 Chipperfield w

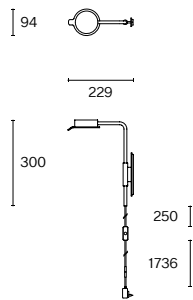

## w102 Chipperfield p

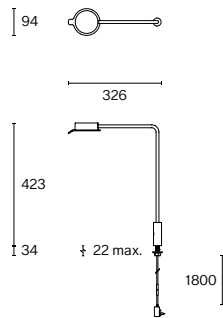

## w102 Chipperfield f

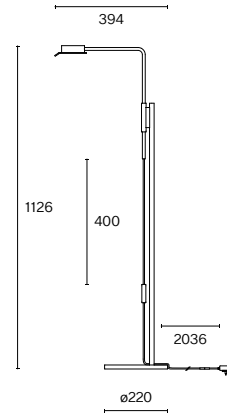

w
Wall bracket
2700 K / 462 lm
100–240 V / 7.5 W
Dimmer switch on cord
0.8 kg

## Art. No. / EAN code / Price VAT excluded

102W100 / 7330492008479	5830 SEK
102W105 / 7330492008486	5830 SEK

p
Pin — integrated (hole ø15 mm)
2700 K / 462 lm
100–240 V / 7.5 W
Integrated dimmer switch
0.9 kg

## Art. No. / EAN code / Price VAT excluded

102P100 / 7330492008455	5830 SEK
102P105 / 7330492008462	5830 SEK

f
Floor base
2700 K / 462 lm
100–240 V / 7.5 W
Dimmer switch on cord
6.2 kg

## Art. No. / EAN code / Price VAT excluded

102F105 / 7330492008509	12320 SEK
102F005 / 7330492008493	12320 SEK

## w222 Focal r

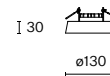

## Technical information

<b>Physical</b>	
<b>Material</b>	Lamp body: aluminium Canopy: polycarbonate
<b>Optics</b>	Lens: PMMA Reflector: polycarbonate
<b>IP rating</b>	20
<b>Protection class</b>	I
<b>LED</b>	
<b>Light source</b>	COB LED (included)
<b>Lifetime expectancy</b>	L80 / 50,000 h
<b>CRI Colour rendering index</b>	90
<b>Stand. deviation of colour</b>	3-step MacAdam
<b>Replaceable by a professional</b>	

## Article-specific information

<b>Version</b>	
<b>Mounting</b>	semi recessed
<b>LED Colour temperature (CCT) / Luminous flux</b>	2700 K / 885 lm
<b>Voltage / System power</b>	220–240 V / 9.6 W
<b>Light control</b>	Phase-cut dim / DALI dim-Push dim
<b>Net weight</b>	0.3 kg
<b>Phase-cut dim</b>	
<b>Traffic white</b>	
<b>Jet black</b>	
<b>Pale red</b>	
<b>Pale green</b>	
<b>Pale blue</b>	
<b>Raw tumbled</b>	
<b>DALI dim-Push dim</b>	
<b>Traffic white</b>	
<b>Jet black</b>	
<b>Pale red</b>	
<b>Pale green</b>	
<b>Pale blue</b>	
<b>Raw tumbled</b>	
<b>Accessories</b>	
<b>Ceiling installation cover plate</b>	
<b>3-phase track DALI adapter white</b>	
<b>3-phase track DALI adapter black</b>	
<b>Casambi module</b>	

<b>Art. No. / EAN code / Price VAT excluded</b>		
222R102271 / 7330492001371		1485 SEK
222R105271 / 7330492001364		1485 SEK
<b>Art. No. / EAN code / Price VAT excluded</b>		
222R120271 / 7330492001388		1485 SEK
<b>Art. No. / EAN code / Price VAT excluded</b>		
222R102272 / 7330492001340		2035 SEK
222R105272 / 7330492001333		2035 SEK
<b>Art. No. / EAN code / Price VAT excluded</b>		
222R120272 / 7330492001357		2035 SEK
<b>Art. No. / EAN code / Price VAT excluded</b>		
DR-0601		2145 SEK

## w222 Focal c

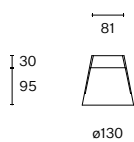

c
ceiling
2700 K / 885 lm
220–240 V / 9.6 W
Phase-cut dim / DALI dim-Push dim / Casambi
0.5 kg

## Art. No. / EAN code / Price VAT excluded

222C102271 / 7330492001395	2090 SEK
222C105271 / 7330492001401	2090 SEK
222C103271 / 7330492001418	2090 SEK
222C101271 / 7330492001425	2090 SEK
222C106271 / 7330492001432	2090 SEK
222C120271 / 7330492001449	2090 SEK

## Art. No. / EAN code / Price VAT excluded

222C102272 / 7330492000367	2640 SEK
222C105272 / 7330492000374	2640 SEK
222C103272 / 7330492000381	2640 SEK
222C101272 / 7330492000398	2640 SEK
222C106272 / 7330492000404	2640 SEK
222C120272 / 7330492001302	2640 SEK

## Art. No. / EAN code / Price VAT excluded

222-JC02	110 SEK
DR-0601	2145 SEK

## w222 Focal w

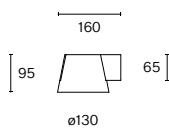

w
wall
2700 K / 885 lm
220–240 V / 9.6 W
Phase-cut dim / DALI dim-Push dim / Casambi
0.5 kg

## Art. No. / EAN code / Price VAT excluded

222W102271 / 7330492001517	2145 SEK
222W105271 / 7330492001524	2145 SEK
222W103271 / 7330492001531	2145 SEK
222W101271 / 7330492001548	2145 SEK
222W106271 / 7330492001555	2145 SEK
222W120271 / 7330492001562	2145 SEK

## Art. No. / EAN code / Price VAT excluded

222W102272 / 7330492000367	2695 SEK
222W105272 / 7330492000374	2695 SEK
222W103272 / 7330492000381	2695 SEK
222W101272 / 7330492000398	2695 SEK
222W106272 / 7330492000404	2695 SEK
222W120272 / 7330492001326	2695 SEK

## Art. No. / EAN code / Price VAT excluded

DR-0601	2145 SEK
---------	----------

## w222 Focal s

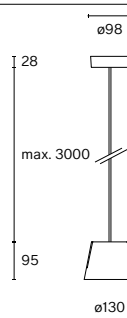

s
ceiling suspended
2700 K / 885 lm
220–240 V / 9.6 W
Phase-cut dim / DALI dim-Push dim / Casambi
0.7 kg

## Art. No. / EAN code / Price VAT excluded

222S102271 / 7330492001456	2695 SEK
222S105271 / 7330492001463	2695 SEK
222S103271 / 7330492001470	2695 SEK
222S101271 / 7330492001487	2695 SEK
222S106271 / 7330492001494	2695 SEK
222S120271 / 7330492001500	2695 SEK

## Art. No. / EAN code / Price VAT excluded

222S102272 / 7330492000411	3245 SEK
222S105272 / 7330492000428	3245 SEK
222S103272 / 7330492000435	3245 SEK
222S101272 / 7330492000442	3245 SEK
222S106272 / 7330492000459	3245 SEK
222S120272 / 7330492001319	3245 SEK

## Art. No. / EAN code / Price VAT excluded

SWADAPT1-001	396 SEK
SWADAPT1-002	396 SEK
DR-0601	2145 SEK

## w202 Halo s2

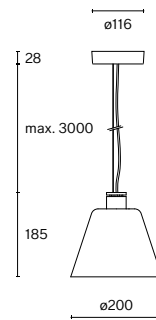

## Technical information

<b>Physical</b>	
<b>Material</b>	Shade & bulb: mouth-blown opal glass Heat sink & top plate: aluminium Canopy: polycarbonate
<b>IP rating</b>	20
<b>Protection class</b>	II
<b>LED</b>	
<b>Light source</b>	COB LED (included)
<b>Lifetime expectancy</b>	L80 / 50,000 h
<b>CRI Colour rendering index</b>	≥ 95
<b>Stand. deviation of colour</b>	3-step MacAdam
<b>Replaceable by a professional</b>	

## Article-specific information

<b>Version</b>	s2
<b>Mounting</b>	Ceiling suspended
<b>LED Colour temperature (CCT) / Luminous flux</b>	2700 K / 449 lm
<b>Voltage / System power</b>	220–240 V / 7.8 W
<b>Light control</b>	Phase-cut dim / DALI dim-Push dim
<b>Net weight</b>	1.2 kg
<b>Phase-cut dim</b>	
<b>White</b>	
<b>DALI dim-Push dim</b>	
<b>White</b>	

<b>Art. No. / EAN code / Price VAT excluded</b>	<b>202S200 / 7330492008691</b>	<b>4180 SEK</b>
<b>Art. No. / EAN code / Price VAT excluded</b>	<b>202S2002 / 7330492000213</b>	<b>4730 SEK</b>

## w202 Halo s3

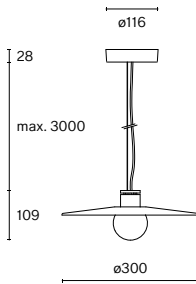

s3
Ceiling suspended
2700 K / 475 lm
220–240 V / 7.8 W
Phase-cut dim / DALI dim-Push dim
1.2 kg

<b>Art. No. / EAN code / Price VAT excluded</b>	
202S300 / 7330492008707	4400 SEK

<b>Art. No. / EAN code / Price VAT excluded</b>	
202S3002 / 7330492000220	4950 SEK

## w202 Halo s4

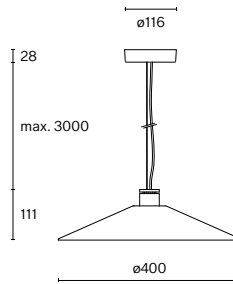

s4
Ceiling suspended
2700 K / 478 lm
220–240 V / 7.8 W
Phase-cut dim / DALI dim-Push dim
2.4 kg

<b>Art. No. / EAN code / Price VAT excluded</b>	
202S400 / 7330492008714	4840 SEK

<b>Art. No. / EAN code / Price VAT excluded</b>	
202S4002 / 7330492000237	5390 SEK



## w131 Bell

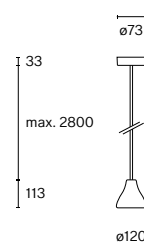
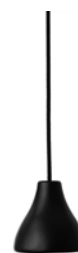

## Technical information

<b>Physical</b>	
<b>Material</b>	Shade: die-cast aluminium Canopy: polyamide Textile cable
<b>Optics</b>	Lens: PMMA Reflector: polycarbonate
<b>IP rating</b>	20
<b>Protection class</b>	II

### LED

<b>Light source</b>	PAR16 – GU10
<b>Lifetime expectancy</b>	L70 / 25,000 h
<b>CRI Colour rendering index</b>	90
<b>Stand. deviation of colour</b>	3-step MacAdam
<b>Replaceable by a professional</b>	

## Article-specific information

<b>Mounting</b>	Ceiling suspended
<b>LED Colour temperature (CCT) / Luminous flux</b>	2700 K / 437 lm 3000 K / 457 lm
<b>Voltage / System power</b>	110–240 V / 6.5 W
<b>Light control</b>	Phase-cut dim
<b>Net weight</b>	0.6 kg

### 2700 K Colour temperature (CCT)

<b>Traffic white</b>	●	<b>131S1901627</b> / 7330492002323	<b>2090 SEK</b>
<b>Jet black</b>	●	<b>131S1900527</b> / 7330492002255	<b>2090 SEK</b>
<b>Silver grey</b>	●	<b>131S1111127</b> / 7330492002231	<b>2090 SEK</b>
<b>Pure orange</b>	●	<b>131S1200427</b> / 7330492002248	<b>2090 SEK</b>
<b>Zink yellow</b>	●	<b>131S1101827</b> / 7330492002262	<b>2090 SEK</b>
<b>Beige</b>	●	<b>131S1100127</b> / 7330492002279	<b>2090 SEK</b>
<b>Traffic red</b>	●	<b>131S1302027</b> / 7330492002286	<b>2090 SEK</b>
<b>Sapphire blue</b>	●	<b>131S1500327</b> / 7330492002293	<b>2090 SEK</b>
<b>Grass green</b>	●	<b>131S1601027</b> / 7330492002309	<b>2090 SEK</b>
<b>Sepia brown</b>	●	<b>131S1801427</b> / 7330492002316	<b>2090 SEK</b>

### 3000 K Colour temperature (CCT)

<b>Traffic white</b>	●	<b>131S1901630</b> / 7330492002422	<b>2090 SEK</b>
<b>Jet black</b>	●	<b>131S1900530</b> / 7330492002354	<b>2090 SEK</b>
<b>Silver grey</b>	●	<b>131S1111130</b> / 7330492002330	<b>2090 SEK</b>
<b>Pure orange</b>	●	<b>131S1200430</b> / 7330492002347	<b>2090 SEK</b>
<b>Zink yellow</b>	●	<b>131S1101830</b> / 7330492002361	<b>2090 SEK</b>
<b>Beige</b>	●	<b>131S1100130</b> / 7330492002378	<b>2090 SEK</b>
<b>Traffic red</b>	●	<b>131S1302030</b> / 7330492002385	<b>2090 SEK</b>
<b>Sapphire blue</b>	●	<b>131S1500330</b> / 7330492002392	<b>2090 SEK</b>
<b>Grass green</b>	●	<b>131S1601030</b> / 7330492002408	<b>2090 SEK</b>
<b>Sepia brown</b>	●	<b>131S1801430</b> / 7330492002415	<b>2090 SEK</b>

### Art. No. / EAN code / Price VAT excluded

<b>131S1901627</b> / 7330492002323	<b>2090 SEK</b>
<b>131S1900527</b> / 7330492002255	<b>2090 SEK</b>
<b>131S1111127</b> / 7330492002231	<b>2090 SEK</b>
<b>131S1200427</b> / 7330492002248	<b>2090 SEK</b>
<b>131S1101827</b> / 7330492002262	<b>2090 SEK</b>
<b>131S1100127</b> / 7330492002279	<b>2090 SEK</b>
<b>131S1302027</b> / 7330492002286	<b>2090 SEK</b>
<b>131S1500327</b> / 7330492002293	<b>2090 SEK</b>
<b>131S1601027</b> / 7330492002309	<b>2090 SEK</b>
<b>131S1801427</b> / 7330492002316	<b>2090 SEK</b>

### Art. No. / EAN code / Price VAT excluded

<b>131S1901630</b> / 7330492002422	<b>2090 SEK</b>
<b>131S1900530</b> / 7330492002354	<b>2090 SEK</b>
<b>131S1111130</b> / 7330492002330	<b>2090 SEK</b>
<b>131S1200430</b> / 7330492002347	<b>2090 SEK</b>
<b>131S1101830</b> / 7330492002361	<b>2090 SEK</b>
<b>131S1100130</b> / 7330492002378	<b>2090 SEK</b>
<b>131S1302030</b> / 7330492002385	<b>2090 SEK</b>
<b>131S1500330</b> / 7330492002392	<b>2090 SEK</b>
<b>131S1601030</b> / 7330492002408	<b>2090 SEK</b>
<b>131S1801430</b> / 7330492002415	<b>2090 SEK</b>

## w151 Extra large pendant s1

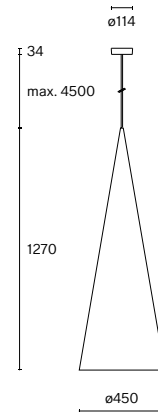

## Technical information

Physical	
<b>Material</b>	Shade: aluminium Canopy: polycarbonate
<b>Optics</b>	Diffuser: acrylic
<b>IP rating</b>	20
<b>Protection class</b>	I

LED	
<b>Light source</b>	Integrated LED
<b>Lifetime expectancy</b>	L80 / 50,000 h
<b>CRI Colour rendering index</b>	≥ 90
<b>Stand. deviation of colour</b>	3-step MacAdam
<b>Replaceable by a professional</b>	

## Article-specific information

Version	
<b>Mounting</b>	
<b>LED Colour temperature (CCT) / Luminous flux</b>	
<b>Voltage / System power</b>	
<b>Light control</b>	
<b>Net weight</b>	

2700 K Colour temperature (CCT)	
<b>Traffic white</b>	
<b>Jet black</b>	
<b>Red orange</b>	
<b>Carmin red</b>	
<b>Purple red</b>	
<b>Raw brushed</b>	

3000 K Colour temperature (CCT)	
<b>Traffic white</b>	
<b>Jet black</b>	
<b>Red orange</b>	
<b>Carmin red</b>	
<b>Purple red</b>	
<b>Raw brushed</b>	

<b>s1</b>
<b>Ceiling suspended</b>
2700 K / 3910 lm
3000 K / 4096 lm
220–240 V / 46 W
Push dim / DALI dim
5.5 kg

Art. No. / EAN code / Price VAT excluded		
<b>151S1279016</b>	/ 7330492008950	<b>30580 SEK</b>
<b>151S1279005</b>	/ 7330492008943	<b>30580 SEK</b>
<b>151S1272001</b>	/ 7330492008967	<b>30580 SEK</b>
<b>151S1270002</b>	/ 7330492000787	<b>30580 SEK</b>

Art. No. / EAN code / Price VAT excluded		
<b>151S1309016</b>	/ 7330492008981	<b>30580 SEK</b>
<b>151S1309005</b>	/ 7330492008974	<b>30580 SEK</b>
<b>151S1302001</b>	/ 7330492008998	<b>30580 SEK</b>
<b>151S1300002</b>	/ 7330492000794	<b>30580 SEK</b>

## w151 Extra large pendant s2

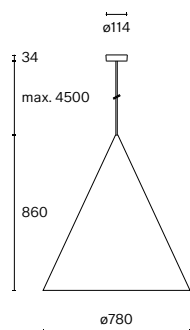

## s2

Ceiling suspended

2700 K / 4437 lm

3000 K / 4647 lm

220–240 V / 46 W

Push dim / DALI dim

6.5 kg

## Art. No. / EAN code / Price VAT excluded

151S2279016 / 7330492009018 32890 SEK

151S2279005 / 07330492009001 32890 SEK

151S2273002 / 7330492009025 32890 SEK

151S2270002 / 7330492000800 32890 SEK

## Art. No. / EAN code / Price VAT excluded

151S2309016 / 7330492009049 32890 SEK

151S2309005 / 7330492009032 32890 SEK

151S2303002 / 7330492009056 32890 SEK

151S2300002 / 7330492000817 32890 SEK

## w151 Extra large pendant s3

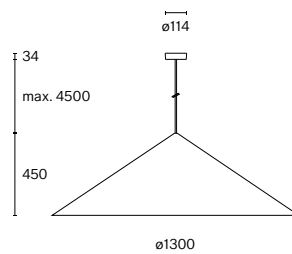

## s3

Ceiling suspended

2700 K / 5091 lm

3000 K / 5331 lm

220–240 V / 46 W

Push dim / DALI dim

11.5 kg

## Art. No. / EAN code / Price VAT excluded

151S3279016 / 7330492009070 37180 SEK

151S3279005 / 7330492009063 37180 SEK

151S3273004 / 7330492009087 37180 SEK

151S3270002 / 7330492000824 37180 SEK

## Art. No. / EAN code / Price VAT excluded

151S3309016 / 7330492009100 37180 SEK

151S3309005 / 7330492009094 37180 SEK

151S3303004 / 7330492009117 37180 SEK

151S3300002 / 7330492000831 37180 SEK

## w221 Medium pendant s1

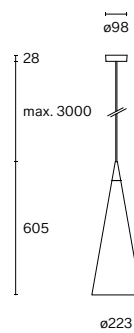

## Technical information

<b>Physical</b>	
<b>Material</b>	Shade: aluminium Canopy: polycarbonate
<b>Optics</b>	Diffuser: acrylic
<b>IP rating</b>	20
<b>Protection class</b>	I

### LED

<b>Light source</b>	LED (included)
<b>Lifetime expectancy</b>	L80 / 50,000 h
<b>CRI Colour rendering index</b>	≥ 90
<b>Stand. deviation of colour</b>	3-step MacAdam
<b>Replaceable by a professional</b>	

## Article-specific information

<b>Version</b>	s1
<b>Mounting</b>	Ceiling suspended
<b>LED Colour temperature (CCT) / Luminous flux</b>	2700 K / 614lm
<b>Voltage / System power</b>	220–240 V / 11 W
<b>Light control</b>	Phase-cut dim / DALI dim-Push dim
<b>Net weight</b>	1,6 kg

### Phase-cut dim

<b>Traffic white</b>	●	<b>221S102271 / 7330492000244</b>	<b>6435 SEK</b>
<b>Jet black</b>	●	<b>221S105271 / 7330492000251</b>	<b>6435 SEK</b>
<b>Raw brushed</b>	●	<b>221S120271 / 7330492001241</b>	<b>6435 SEK</b>

### DALI dim-Push dim

<b>Traffic white</b>	●	<b>221S102272 / 7330492000305</b>	<b>6985 SEK</b>
<b>Jet black</b>	●	<b>221S105272 / 7330492000312</b>	<b>6985 SEK</b>
<b>Raw brushed</b>	●	<b>221S120272 / 7330492001258</b>	<b>6985 SEK</b>

### Accessories

<b>3-phase track adapter white</b>	●	<b>ACC00202 / 7330492001944</b>	<b>220 SEK</b>
<b>3-phase track adapter black</b>	●	<b>ACC00205 / 7330492001951</b>	<b>220 SEK</b>

<b>Art. No. / EAN code / Price VAT excluded</b>	
<b>221S102271 / 7330492000244</b>	<b>6435 SEK</b>
<b>221S105271 / 7330492000251</b>	<b>6435 SEK</b>
<b>221S120271 / 7330492001241</b>	<b>6435 SEK</b>

### Art. No. / EAN code / Price VAT excluded

<b>221S102271 / 7330492000244</b>	<b>6435 SEK</b>
<b>221S105271 / 7330492000251</b>	<b>6435 SEK</b>
<b>221S120271 / 7330492001241</b>	<b>6435 SEK</b>

### Art. No. / EAN code / Price VAT excluded

<b>221S102272 / 7330492000305</b>	<b>6985 SEK</b>
<b>221S105272 / 7330492000312</b>	<b>6985 SEK</b>
<b>221S120272 / 7330492001258</b>	<b>6985 SEK</b>

### Art. No. / EAN code / Price VAT excluded

<b>ACC00202 / 7330492001944</b>	<b>220 SEK</b>
<b>ACC00205 / 7330492001951</b>	<b>220 SEK</b>

w221 Medium pendant s2



w221 Medium pendant s3

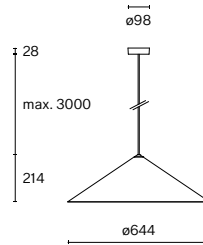
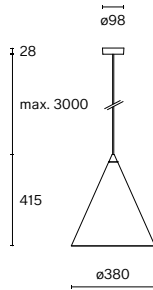

s2
Ceiling suspended
2700 K / 922 lm
220–240 V / 11 W
Phase-cut dim / DALI dim-Push dim
2.1 kg

s3
Ceiling suspended
2700 K / 1008 lm
220–240 V / 11 W
Phase-cut dim / DALI dim-Push dim
2.8 kg

## Art. No. / EAN code / Price VAT excluded

221S202271 / 7330492000268	6655 SEK
221S205271 / 7330492000275	6655 SEK
221S220271 / 7330492001265	6655 SEK

## Art. No. / EAN code / Price VAT excluded

221S302271 / 7330492000282	8085 SEK
221S305271 / 7330492000299	8085 SEK
221S320271 / 7330492001289	8085 SEK

## Art. No. / EAN code / Price VAT excluded

221S202272 / 7330492000329	7205 SEK
221S205272 / 7330492000336	7205 SEK
221S220272 / 7330492001272	7205 SEK

## Art. No. / EAN code / Price VAT excluded

221S302272 / 7330492000343	8635 SEK
221S305272 / 7330492000350	8635 SEK
221S320272 / 7330492001296	8635 SEK

## Art. No. / EAN code / Price VAT excluded

ACC00202 / 7330492001944	220 SEK
ACC00205 / 7330492001951	220 SEK

## Art. No. / EAN code / Price VAT excluded

ACC00202 / 7330492001944	220 SEK
ACC00205 / 7330492001951	220 SEK

## w201 Extra small pendant s1

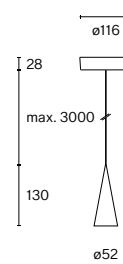

## Technical information

<b>Physical</b>	
<b>Material</b>	Shade: solid aluminium Canopy: polycarbonate
<b>Optics</b>	Reflector & diffuser prism: polycarbonate
<b>IP rating</b>	20
<b>Protection class</b>	II

<b>LED</b>	
<b>Light source</b>	COB LED (included)
<b>Lifetime expectancy</b>	L80 / 50,000 h
<b>CRI Colour rendering index</b>	97
<b>Stand. deviation of colour</b>	3-step MacAdam
<b>Replaceable by a professional</b>	

## Article-specific information

<b>Version</b>	s1
<b>Mounting</b>	Ceiling suspended
<b>LED Colour temperature (CCT) / Luminous flux</b>	2700 K / 424 lm
<b>Voltage / System power</b>	220–240 V / 7.8 W
<b>Light control</b>	Phase-cut dim / DALI dim-Push dim
<b>Net weight</b>	0,4 kg

<b>Phase-cut dim</b>	
<b>Traffic white</b>	●
<b>Jet black</b>	●
<b>Raw brushed</b>	●

<b>DALI dim-Push dim</b>	
<b>Traffic white</b>	●
<b>Jet black</b>	●
<b>Raw brushed</b>	●

<b>Art. No. / EAN code / Price VAT excluded</b>	
<b>201S129016 / 7330492008608</b>	<b>2640 SEK</b>
<b>201S129005 / 7330492008615</b>	<b>2640 SEK</b>
<b>201S120002 / 7330492001180</b>	<b>2640 SEK</b>

<b>Art. No. / EAN code / Price VAT excluded</b>	
<b>201S1290162 / 7330492000152</b>	<b>3190 SEK</b>
<b>201S1290052 / 7330492000169</b>	<b>3190 SEK</b>
<b>201S1200022 / 7330492001197</b>	<b>3190 SEK</b>

w201 Extra small pendant s2



w201 Extra small pendant s3

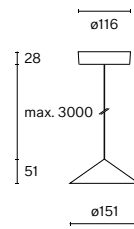
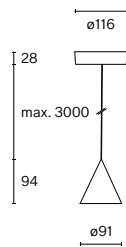

s2
Ceiling suspended
2700 K / 446 lm
220–240 V / 7.8 W
Phase-cut dim / DALI dim-Push dim
0.4 kg

## Art. No. / EAN code / Price VAT excluded

201S229016 / 7330492008608	2860 SEK
201S229005 / 7330492008615	2860 SEK
201S220002 / 7330492001203	2860 SEK

## Art. No. / EAN code / Price VAT excluded

201S2290162 / 7330492000176	3410 SEK
201S2290052 / 7330492000183	3410 SEK
201S2200022 / 7330492001210	3410 SEK

s3
Ceiling suspended
2700 K / 446 lm
220–240 V / 7.8 W
Phase-cut dim / DALI dim-Push dim
0.4 kg

## Art. No. / EAN code / Price VAT excluded

201S329016 / 7330492008660	3080 SEK
201S329005 / 7330492008677	3080 SEK
201S320002 / 7330492001227	3080 SEK

## Art. No. / EAN code / Price VAT excluded

201S3290162 / 7330492000190	3630 SEK
201S3290052 / 7330492000206	3630 SEK
201S3200022 / 7330492001234	3630 SEK

## w162 Dalston s1

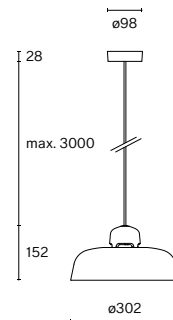

## Technical information

<b>Physical</b>	
<b>Material</b>	Shade: aluminium / die-cast aluminium LED engine: die-cast aluminium Canopy: polycarbonate Textile cable
<b>Optics</b>	Reflector & diffuser prism: polycarbonate
<b>IP rating</b>	20
<b>Protection class</b>	I
<b>LED</b>	
<b>Light source</b>	COB LED (included)
<b>Lifetime expectancy</b>	L80 / 50,000 h
<b>CRI Colour rendering index</b>	≥ 90
<b>Stand. deviation of colour</b>	3-step MacAdam
<b>Replaceable by a professional</b>	

## Article-specific information

<b>Version</b>	s1
<b>Mounting</b>	Ceiling suspended
<b>LED Colour temperature (CCT) / Luminous flux</b>	2700 K / 524 lm
<b>Voltage / System power</b>	220–240 V / 9 W
<b>Light control</b>	Phase-cut dim
<b>Net weight</b>	1.2 kg

<b>Colour/Finish</b>	
<b>Graphite black</b>	●
<b>Silk grey</b>	●
<b>Nut brown</b>	●
<b>Olive green</b>	●
<b>Raw tumbled/aluminium (painted)</b>	●

<b>Accessories</b>	
<b>1-phase track adapter white</b>	●
<b>1-phase track adapter black</b>	●
<b>3-phase track adapter white</b>	●
<b>3-phase track adapter black</b>	●

<b>Art. No. / EAN code / Price VAT excluded</b>		
<b>162S119011</b> / 7330492009131		<b>4125 SEK</b>
<b>162S127044</b> / 7330492009193		<b>4125 SEK</b>
<b>162S138011</b> / 7330492009254		<b>4125 SEK</b>
<b>162S146003</b> / 7330492009315		<b>4125 SEK</b>
<b>162S150002</b> / 7330492000893		<b>4125 SEK</b>

<b>Art. No. / EAN code / Price VAT excluded</b>		
<b>ACC00102</b> / 7330492001920		<b>187 SEK</b>
<b>ACC00105</b> / 7330492001937		<b>187 SEK</b>
<b>ACC00202</b> / 7330492001944		<b>220 SEK</b>
<b>ACC00205</b> / 7330492001951		<b>220 SEK</b>



## w162 Dalston s2

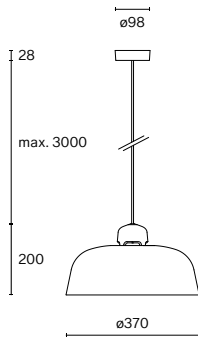

s2

Ceiling suspended

2700 K / 515 lm

220–240 V / 9 W

Phase-cut dim

1.6 kg

## Art. No. / EAN code / Price VAT excluded

162S219011 / 7330492009322	4455 SEK
162S227044 / 7330492009377	4455 SEK
162S238011 / 7330492009421	4455 SEK
162S246003 / 7330492009476	4455 SEK
162S250002 / 7330492000985	4455 SEK

## Art. No. / EAN code / Price VAT excluded

ACC00102 / 7330492001920	187 SEK
ACC00105 / 7330492001937	187 SEK
ACC00202 / 7330492001944	220 SEK
ACC00205 / 7330492001951	220 SEK

## w162 Dalston s3

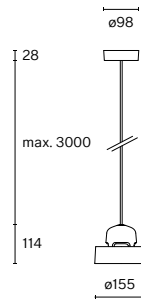

s3

Ceiling suspended

2700 K / 501 lm

220–240 V / 9 W

Phase-cut dim

1.4 kg

## Art. No. / EAN code / Price VAT excluded

162S319011 / 7330492001135	3850 SEK
162S327044 / 7330492001098	3850 SEK
162S350002 / 7330492001074	3850 SEK

## Art. No. / EAN code / Price VAT excluded

ACC00102 / 7330492001920	187 SEK
ACC00105 / 7330492001937	187 SEK
ACC00202 / 7330492001944	220 SEK
ACC00205 / 7330492001951	220 SEK

See configurator on [wastberg.com/products/w162-dalston](http://wastberg.com/products/w162-dalston) for all colour combinations.

## w182 Pastille b2

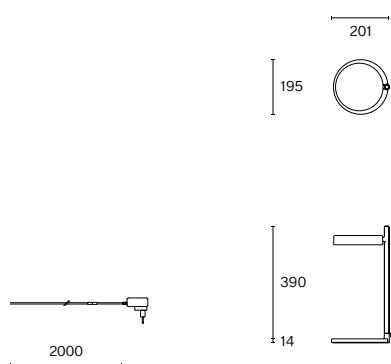

## Technical information

<b>Physical</b>	
<b>Material</b>	Lamp body: biopolyamide Table base/clamp: biopolyamide & steel Pin/bracket: biopolyamide Floor stand: steel
<b>Optics</b>	Reflector: ABS Diffuser: polycarbonate
<b>IP rating</b>	20
<b>Protection class</b>	III
<b>LED</b>	
<b>Light source</b>	COB LED (included)
<b>Lifetime expectancy</b>	L80 / 50,000 h
<b>CRI Colour rendering index</b>	96
<b>Stand. deviation of colour</b>	3-step MacAdam
<b>Replaceable by a professional</b>	

## Article-specific information

<b>Version</b>	
<b>Mounting</b>	
<b>LED Colour temperature (CCT) / Luminous flux</b>	
<b>Voltage / System power</b>	
<b>Light control</b>	
<b>Net weight</b>	
<b>Colour</b>	
<b>Soft white</b>	●
<b>Graphite black</b>	●
<b>Olive green</b>	●
<b>Oxide red</b>	●
<b>Accessories</b>	
<b>Adapter suitable for Vitra AdHoc</b>	
<b>Adapter suitable for Vitra Tyde</b>	

<b>b2</b>	
<b>Base</b>	
2700 K / 457 lm	
100–240 V / 7.3 W	
Dimmable	
1.8 kg	

<b>Art. No. / EAN code / Price VAT excluded</b>		
<b>182B20250</b>	/ 7330492008103	<b>3575 SEK</b>
<b>182B29011</b>	/ 7330492008110	<b>3575 SEK</b>
<b>182B26003</b>	/ 7330492008097	<b>3575 SEK</b>
<b>182B23009</b>	/ 7330492008080	<b>3575 SEK</b>

<b>Art. No. / EAN code / Price VAT excluded</b>		

## w182 Pastille p2



## w182 Pastille c1



## w182 Pastille c2

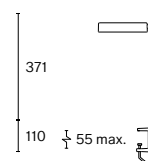
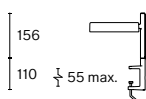
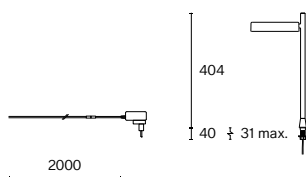
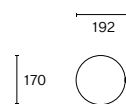
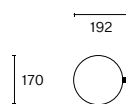
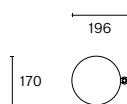

p2

Pin – Integrated (hole  $\varnothing$ 20 mm)

2700 K / 457 lm

100–240 V / 7.3 W

Dimmable

0.7 kg

c1

Clamp

2700 K / 457 lm

10w0–240 V / 7.3 W

Dimmable

0.8 kg

c2

Clamp

2700 K / 457 lm

10w0–240 V / 7.3 W

Dimmable

0.8 kg

## Art. No. / EAN code / Price VAT excluded

182P20250 / 7330492008387	2970 SEK
182P29011 / 7330492008394	2970 SEK
182P26003 / 7330492008370	2970 SEK
182P23009 / 7330492008363	2970 SEK

## Art. No. / EAN code / Price VAT excluded

182C10250 / 7330492008226	3080 SEK
182C19011 / 7330492008233	3080 SEK
182C16003 / 7330492008219	3080 SEK
182C13009 / 7330492008202	3080 SEK

## Art. No. / EAN code / Price VAT excluded

182C20250 / 7330492008264	3300 SEK
182C29011 / 7330492008271	3300 SEK
182C26003 / 7330492008257	3300 SEK
182C23009 / 7330492008240	3300 SEK

## Art. No. / EAN code / Price VAT excluded

182-PVI01	220 SEK
182-PVI03	220 SEK

## Art. No. / EAN code / Price VAT excluded

## Art. No. / EAN code / Price VAT excluded

## w182 Pastille br1

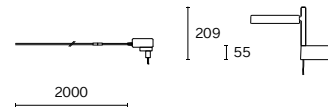
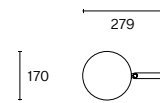

## Technical information

<b>Physical</b>	
<b>Material</b>	Lamp body: biopolyamide Table base/clamp: biopolyamide & steel Pin/bracket: biopolyamide Floor stand: steel
<b>Optics</b>	Reflector: ABS Diffuser: polycarbonate
<b>IP rating</b>	20
<b>Protection class</b>	III
<b>LED</b>	
<b>Light source</b>	COB LED (included)
<b>Lifetime expectancy</b>	L80 / 50,000 h
<b>CRI Colour rendering index</b>	96
<b>Stand. deviation of colour</b>	3-step MacAdam
<b>Replaceable by a professional</b>	

## Article-specific information

<b>Version</b>	
<b>Mounting</b>	
<b>LED Colour temperature (CCT) / Luminous flux</b>	
<b>Voltage / System power</b>	
<b>Light control</b>	
<b>Net weight</b>	
<b>Colour</b>	
<b>Soft white</b>	●
<b>Graphite black</b>	●
<b>Olive green</b>	●
<b>Oxide red</b>	●

<b>br1</b>		
<b>Wall bracket</b>		
2700 K / 457 lm		
100–240 V / 7.3 W		
Dimmable		
0.8 kg		
<b>Art. No. / EAN code / Price VAT excluded</b>		
<b>182BR10250</b> / 7330492008141		<b>2915 SEK</b>
<b>182BR19011</b> / 7330492008158		<b>2915 SEK</b>
<b>182BR16003</b> / 7330492008134		<b>2915 SEK</b>
<b>182BR13009</b> / 7330492008127		<b>2915 SEK</b>

w182 Pastille br2

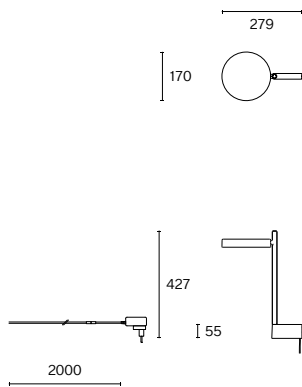

br2
Wall bracket
2700 K / 457 lm
100–240 V / 7.3 W
Dimmable
0.8 kg

## Art. No. / EAN code / Price VAT excluded

182BR20250 / 7330492008189	3135 SEK
182BR29011 / 7330492008196	3135 SEK
182BR26003 / 7330492008172	3135 SEK
182BR23009 / 7330492008165	3135 SEK

w182 Pastille f2

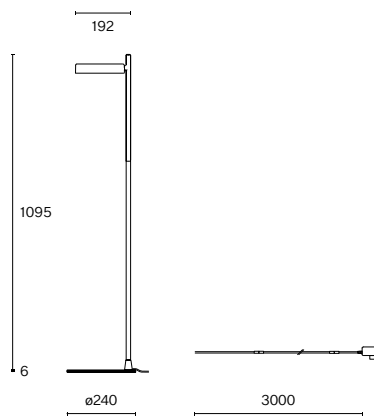

f2
Floor base
2700 K / 457 lm
10w0–240 V / 7.3 W
Dimmable
3.4 kg

## Art. No. / EAN code / Price VAT excluded

182F20250 / 7330492008349	5720 SEK
182F29011 / 7330492008356	5720 SEK
182F26003 / 7330492008332	5720 SEK
182F23009 / 7330492008325	5720 SEK

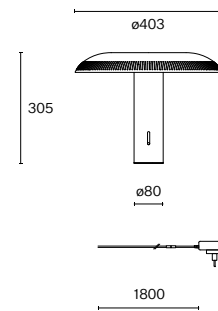

## w203 Illumina white



## Technical information

<b>Physical</b>	
<b>Material</b>	Shade & base: aluminium/ copper Dimmer knob & internal structure: ABS
<b>Optics</b>	Reflector: ABS Diffuser: polycarbonate
<b>IP rating</b>	20
<b>Protection class</b>	III
<b>LED</b>	
<b>Light source</b>	COB LED (included)
<b>Lifetime expectancy</b>	L80 / 50,000 h
<b>CRI Colour rendering index</b>	≥ 90
<b>Stand. deviation of colour</b>	3-step MacAdam
<b>Replaceable by a professional</b>	

## Article-specific information

<b>Version</b>	
<b>LED Colour temperature (CCT) / Luminous flux</b>	
<b>Voltage / System power</b>	
<b>Light control</b>	
<b>Net weight</b>	
<b>Colour/Finish</b>	
<b>White</b>	
<b>Raw brushed</b>	
<b>Copper</b>	

<b>White</b>	
<b>2700 K / 267 lm</b>	
<b>100–240 V / 8 W</b>	
<b>Integrated sliding dimmer potentiometer</b>	
<b>1.6 kg</b>	
<b>Art. No. / EAN code / Price VAT excluded</b>	
<b>203T100 / 7330492008721</b>	<b>6380 SEK</b>

## w203 Illumina aluminium



## w203 Illumina copper

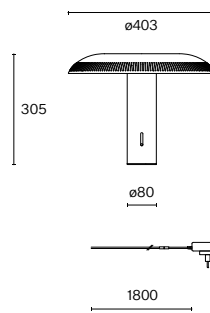
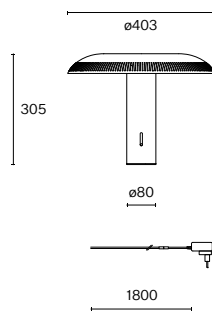

Aluminium
2700 K / 267 lm
100–240 V / 8 W
Integrated sliding dimmer potentiometer
1.6 kg

Art. No. / EAN code / Price VAT excluded

**203T200 / 7330492008738 7150 SEK**

Copper
2700 K / 267 lm
100–240 V / 8 W
Integrated sliding dimmer potentiometer
3.6 kg

Art. No. / EAN code / Price VAT excluded

**203T300 / 7330492008745 13090 SEK**

## w132 Nendo t

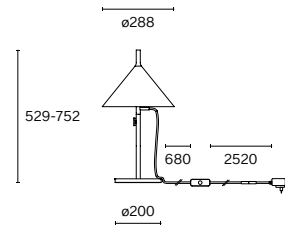

## Technical information

<b>Physical</b>	
<b>Material</b>	Shade: aluminium Base & pole: steel LED engine: aluminium & PMMA Canopy: polycarbonate
<b>Optics</b>	Opal diffuser
<b>IP rating</b>	20
<b>Protection class</b>	I
<b>LED</b>	
<b>Light source</b>	Integrated LED
<b>Lifetime expectancy</b>	L80 / 50,000 h
<b>CRI Colour rendering index</b>	≥ 90
<b>Stand. deviation of colour</b>	3-step MacAdam
<b>Replaceable by a professional</b>	

## Article-specific information

<b>Version</b>	
<b>Mounting</b>	
<b>LED Colour temperature (CCT) / Luminous flux</b>	
<b>Voltage / System power</b>	
<b>Light control</b>	
<b>Net weight</b>	
<b>Colour</b>	
<b>Traffic white</b>	<input type="radio"/>
<b>Jet black</b>	<input checked="" type="radio"/>
<b>Accessories</b>	
<b>3-phase track adapter with steel wire suspension</b>	<input type="radio"/>
<b>3-phase track adapter with steel wire suspension</b>	<input checked="" type="radio"/>

<b>t</b>	
<b>Base</b>	
	2700 K / 850 lm
	100–240 V / 15 W
	Dimmer switch on cord
	6.3 kg

<b>Art. No. / EAN code / Price VAT excluded</b>		
<b>132T102</b> / 7330492006697		<b>7315 SEK</b>
<b>132T105</b> / 7330492006710		<b>7315 SEK</b>

<b>Art. No. / EAN code / Price VAT excluded</b>		



w132 Nendo f

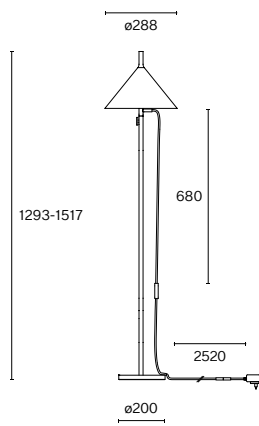
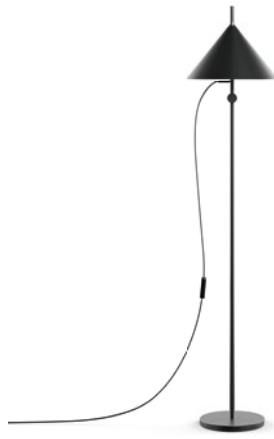

w132 Nendo s

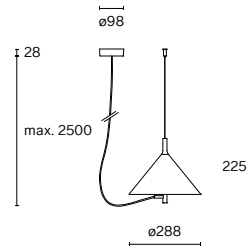

f
Floor base
2700K / 850lm
100–240V / 15W
Dimmer switch on cord
7.0 kg

## Art. No. / EAN code / Price VAT excluded

<b>132F102</b> / 7330492006512	<b>7645 SEK</b>
<b>132F105</b> / 7330492006536	<b>7645 SEK</b>

## Art. No. / EAN code / Price VAT excluded

s
Ceiling suspended
2700K / 850lm
100–240V / 15W
Phase-cut dim
1.9 kg

## Art. No. / EAN code / Price VAT excluded

<b>132S102</b> / 7330492006604	<b>4895 SEK</b>
<b>132S105</b> / 7330492006628	<b>4895 SEK</b>

## Art. No. / EAN code / Price VAT excluded

<b>132SACC00102</b> / 7330492001968	<b>539 SEK</b>
<b>132SACC00105</b> / 7330492001975	<b>539 SEK</b>

## w223 Pawson marble

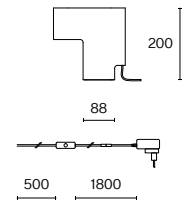
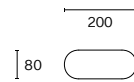

## Technical information

<b>Physical</b>	
<b>Material</b>	Lamp body: marble/ aluminium Dimmer housing on cord: ABS
<b>Optics</b>	Lens: polycarbonate
<b>IP rating</b>	20
<b>Protection class</b>	III
<b>LED</b>	
<b>Light source</b>	Integrated LED
<b>Lifetime expectancy</b>	L80 / 50,000 h
<b>CRI Colour rendering index</b>	≥ 95
<b>Stand. deviation of colour</b>	3-step MacAdam
<b>Replaceable by a professional</b>	

## Article-specific information

<b>Version</b>	
<b>Mounting</b>	
<b>LED Colour temperature (CCT) / Luminous flux</b>	
<b>Voltage / System power</b>	
<b>Light control</b>	
<b>Net weight</b>	
<b>Colour/Finish</b>	
<b>Marble</b>	●
<b>Aluminium painted</b>	●

<b>Marble</b>	
<b>Base</b>	
<b>LED Colour temperature (CCT) / Luminous flux</b>	2700 K / 115 lm
<b>Voltage / System power</b>	100–240 V / 7.8 W
<b>Light control</b>	Dimmer switch on cord
<b>Net weight</b>	5.1 kg
<b>Art. No. / EAN code / Price VAT excluded</b>	
<b>223T14027 / 7330492000527</b>	<b>24750 SEK</b>

---

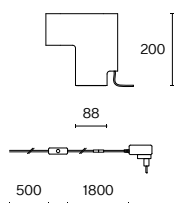
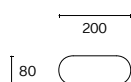
**w223 Pawson aluminium**



---

 Aluminium

---

 Base

---

 2700 K / 135 lm

---

 100–240 V / 7.8 W

---

 Dimmer switch on cord

---

 1.2 kg

---

**Art. No. / EAN code / Price VAT excluded**



---

**223T12027 / 7330492000534**

---

**4345 SEK**

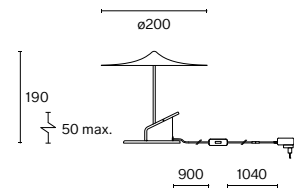
## w153 l e



## Technical information

Physical	
Material	Shade & base: aluminium
Optics	Reflector: ABS Diffuser: PMMA
IP rating	20
Protection class	III

LED	
Light source	COB LED (included)
Lifetime expectancy	L80 / 50,000 h
CRI Colour rendering index	97
Stand. deviation of colour	3-step MacAdam
Replaceable by a professional	

## Article-specific information

Mounting	
LED Colour temperature (CCT) / Luminous flux	
Voltage / System power	
Light control	
Net weight	

Colour	
Traffic white	●
Jet black	●
Poppy red	●
Sky blue	●
Light yellow	●
Grey brown	●
Petrol	●

Base, clamp and wall-mounted
2700 K / 110lm
100–240 V / 7.5 W
On/Off Switch on cord
0.4 kg

Art. No. / EAN code / Price VAT excluded		
153M19016 / 7330492007991		2145 SEK
153M19005 / 7330492007984		2145 SEK
153M10580 / 7330492006062		2145 SEK
153M10515 / 7330492006079		2145 SEK
153M11020 / 7330492006086		2145 SEK
153M15010 / 7330492006093		2145 SEK
153M16530 / 7330492006109		2145 SEK

## w103 Sempé s1

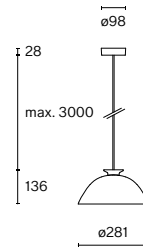

## Technical information

<b>Physical</b>	
<b>Material</b>	Shade, LED engine & rail: aluminium Canopy: polycarbonate
<b>Optics</b>	Diffuser: polycarbonate
<b>IP rating</b>	20
<b>Protection class</b>	I

### LED

<b>Light source</b>	Integrated LED
<b>Lifetime expectancy</b>	L80 / 50,000 h
<b>CRI Colour rendering index</b>	97
<b>Stand. deviation of colour</b>	3-step MacAdam
<b>Replaceable by a professional</b>	

## Article-specific information

<b>Version</b>	
<b>Mounting</b>	
<b>LED Colour temperature (CCT) / Luminous flux</b>	
<b>Voltage / System power</b>	
<b>Light control</b>	
<b>Net weight</b>	

### Colour

<b>Traffic white</b>	●
<b>Jet black</b>	●
<b>Poppy red</b>	●
<b>Light yellow</b>	●
<b>Grey brown</b>	●
<b>Slate blue</b>	●

### Accessories

<b>1-phase track adapter white</b>	●
<b>1-phase track adapter black</b>	●
<b>3-phase track adapter white</b>	●
<b>3-phase track adapter black</b>	●

<b>s1</b>	
Ceiling suspended –	
Canopy included	
2700 K / 414 lm	
220–240 V / 8.4 W	
Phase-cut dim	
0.9 kg	

### Art. No. / EAN code / Price VAT excluded

<b>103S19016</b> / 7330492005911	<b>3905 SEK</b>
<b>103S19005</b> / 7330492005973	<b>3905 SEK</b>
<b>103S10580</b> / 7330492000022	<b>3905 SEK</b>
<b>103S11020</b> / 7330492000039	<b>3905 SEK</b>
<b>103S15010</b> / 7330492000046	<b>3905 SEK</b>
<b>103S17697</b> / 7330492000053	<b>3905 SEK</b>

### Art. No. / EAN code / Price VAT excluded

<b>ACC00102</b> / 7330492001920	<b>187 SEK</b>
<b>ACC00105</b> / 7330492001937	<b>187 SEK</b>
<b>ACC00202</b> / 7330492001944	<b>220 SEK</b>
<b>ACC00205</b> / 7330492001951	<b>220 SEK</b>

## w103 Sempé s3

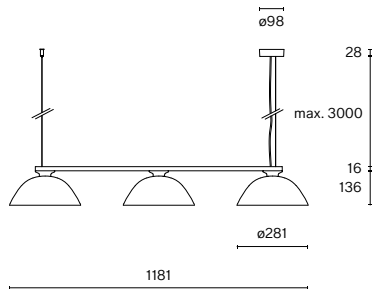

s3

Ceiling suspended –

Canopy and steel wire attachment included

2700 K / 414 lm

220–240 V / 25 W

Phase-cut dim

2.7 kg

## Art. No. / EAN code / Price VAT excluded

103S39016 / 7330492006017 10560 SEK

103S39005 / 7330492006024 10560 SEK

103S35010 / 7330492000060 10560 SEK

## Art. No. / EAN code / Price VAT excluded

## w103 Sempé b

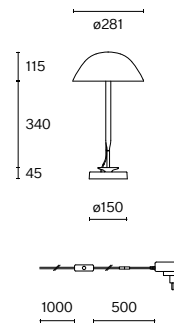

## Technical information

<b>Physical</b>	
<b>Material</b>	Shade & LED engine: aluminium Arm: aluminium & steel Base & clamp: iron
<b>Optics</b>	Diffuser: polycarbonate
<b>IP rating</b>	20
<b>Protection class</b>	III
<b>LED</b>	
<b>Light source</b>	Integrated LED
<b>Lifetime expectancy</b>	L80 / 50,000 h
<b>CRI Colour rendering index</b>	97
<b>Stand. deviation of colour</b>	3-step MacAdam
<b>Replaceable by a professional</b>	

## Article-specific information

<b>Version</b>	
<b>Mounting</b>	
<b>LED Colour temperature (CCT) / Luminous flux</b>	
<b>Voltage / System power</b>	
<b>Light control</b>	
<b>Net weight</b>	
<b>Colour</b>	
<b>Traffic white</b>	●
<b>Jet black</b>	●
<b>Grey brown</b>	●

<b>b</b>	
<b>Base</b>	
2700 K / 414 lm	
100–240 V / 8.4 W	
Dimmable	
4.3 kg	
<b>Art. No. / EAN code / Price VAT excluded</b>	
<b>103B19016 / 7330492005850</b>	<b>6545 SEK</b>
<b>103B19005 / 7330492005836</b>	<b>6545 SEK</b>
<b>103B15010 / 7330492000008</b>	<b>6545 SEK</b>

---

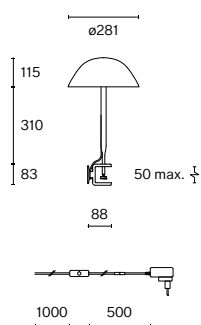
**w103 Sempé c**

c
Clamp
2700 K / 414 lm
100–240 V / 8.4 W
Dimmable
1.2 kg

---

**Art. No. / EAN code / Price VAT excluded**

<b>103C19016</b> / 7330492005898	<b>5060 SEK</b>
<b>103C19005</b> / 7330492005874	<b>5060 SEK</b>
<b>103C15010</b> / 7330492000015	<b>5060 SEK</b>



## w171 Alma cw

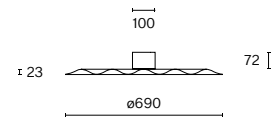
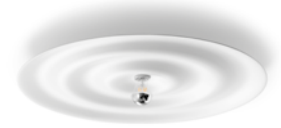

## Technical information

<b>Physical</b>	
<b>Material</b>	Shade: aluminium Ceiling/wall bracket: steel Canopy: polycarbonate
<b>IP rating</b>	20
<b>Protection class</b>	cw: I s/w: II
<b>LED</b>	
<b>Light source</b>	1 x E27 socket
<b>Lifetime expectancy</b>	15,000 h
<b>CRI Colour rendering index</b>	≥ 80
<b>Replaceable light source by end-user</b>	

## Article-specific information

<b>Version</b>	
<b>Mounting</b>	
<b>LED Colour temperature (CCT) / Luminous flux</b>	
<b>Voltage / System power</b>	
<b>Light control</b>	
<b>Net weight</b>	
<b>Colour/Finish</b>	
<b>Signal white</b>	<input type="radio"/>
<b>Grey white</b>	<input type="radio"/>
<b>Raw</b>	<input type="radio"/>
<b>Accessories</b>	
<b>1-phase track adapter white</b>	<input type="radio"/>
<b>1-phase track adapter black</b>	<input type="radio"/>
<b>3-phase track adapter white</b>	<input type="radio"/>
<b>3-phase track adapter black</b>	<input type="radio"/>

<b>Art. No. / EAN code / Price VAT excluded</b>	
<b>171C/W19003 / 7330492007939</b>	<b>4345 SEK</b>
<b>171C/W19002 / 7330492007922</b>	<b>4345 SEK</b>
<b>171C/W10002 / 7330492001739</b>	<b>4345 SEK</b>

w171 Alma s

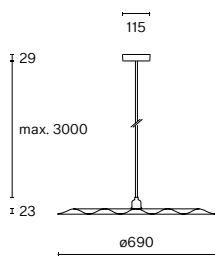

w171 Alma w

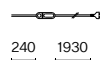
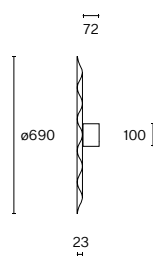

s
Ceiling suspended
2700 K / 660 lm
220–240 V / Max. 12 W LED
Phase-cut dim
2.6 kg

## Art. No. / EAN code / Price VAT excluded

171S19003 / 7330492007953	4785 SEK
171S19002 / 7330492007946	4785 SEK
171S10002 / 7330492001715	4785 SEK

## Art. No. / EAN code / Price VAT excluded

ACC00102 / 7330492005409	187 SEK
ACC00105 / 7330492005409	187 SEK
ACC00202 / 7330492005409	220 SEK
ACC00205 / 7330492005409	220 SEK

w
Wall
2700 K / 660 lm
220–240 V / Max. 12 W LED
Dimmer switch on cord
4.1 kg

## Art. No. / EAN code / Price VAT excluded

171W19003 / 7330492007977	5885 SEK
171W19002 / 7330492007960	5885 SEK
171W10002 / 7330492001722	5885 SEK

## w164 Alto

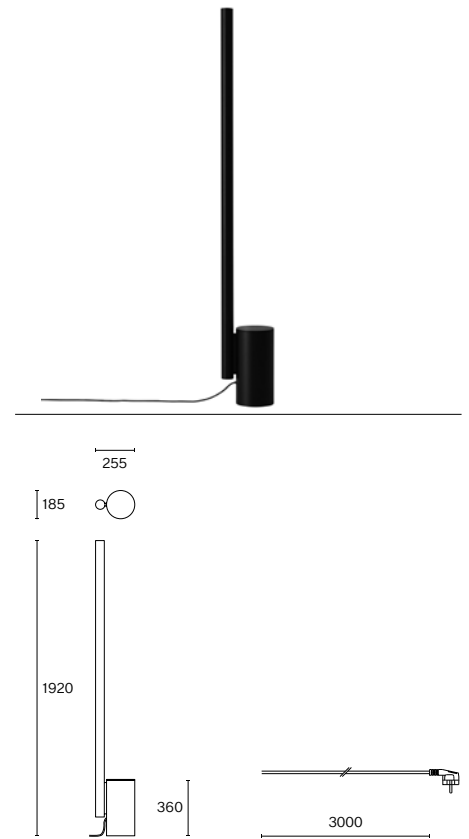

## Technical information

Physical	
Material	Aluminium
IP rating	20
Protection class	I

LED	
Light source	COB LED (included)
Lifetime expectancy	L80 / 50,000 h
CRI Colour rendering index	>90
Stand. deviation of colour	3-step MacAdam
Replaceable by a professional	

## Article-specific information

Mounting	
LED Colour temperature (CCT) / Luminous flux	
Voltage / System power	
Light control	
Net weight	

Colour	
Traffic white	<input type="radio"/>
Jet black	<input checked="" type="radio"/>

Free-standing	
3000 K / 4459 lm	
220–240 V / 50 W	
Integrated rotary dimmer	
15.2 kg	

Art. No. / EAN code / Price VAT excluded		
164F102 / 7330492007588		15345 SEK
164F105 / 7330492007601		15345 SEK

## w224 Alto pendant s1

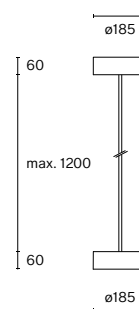

## Technical information

<b>Physical</b>	
<b>Material</b>	Canopy, rod & lamp body: aluminium
<b>Optics</b>	Reflector: polycarbonate Cover: glass
<b>IP rating</b>	20
<b>Protection class</b>	I

### LED

<b>Light source</b>	COB LED
<b>Lifetime expectancy</b>	L80 / 50,000 h
<b>CRI Colour rendering index</b>	≥ 90
<b>Stand. deviation of colour</b>	3-step MacAdam
<b>Replaceable by a professional</b>	

## Article-specific information

<b>Version</b>	
<b>Mounting</b>	
<b>LED Colour temperature (CCT) / Luminous flux</b>	
<b>Voltage / System power</b>	
<b>Light control</b>	
<b>Net weight</b>	

### 2700 K Colour temperature (CCT)

<b>Traffic white</b>	●
<b>Jet black</b>	●
<b>Raw tumbled</b>	●

### 3000 K Colour temperature (CCT)

<b>Traffic white</b>	●
<b>Jet black</b>	●
<b>Raw tumbled</b>	●

### Accessories

<b>Casambi module</b> (not for Raw tumbled)
---

<b>s1</b>	
<b>Ceiling suspended</b>	
2700 K / 10350 lm	
3000 K / 10790 lm	
220–240 V / 91 W	
Push dim / DALI dim	
2.8 kg	

### Art. No. / EAN code / Price VAT excluded

<b>224S1S02272</b>	<b>13090 SEK</b>
<b>224S1S05272</b>	<b>13090 SEK</b>

### Art. No. / EAN code / Price VAT excluded

<b>224S1S02302</b>	<b>13090 SEK</b>
<b>224S1S05302</b>	<b>13090 SEK</b>

### Art. No. / EAN code / Price VAT excluded

<b>DR-0601 / 7330492000510</b>	<b>2145 SEK</b>
--------------------------------	-----------------

w224 Alto pendant s2

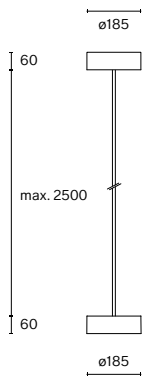

w224 Alto pendant s1 r

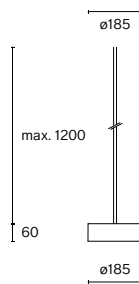

w224 Alto pendant s2 r

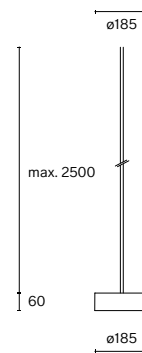

s2
Ceiling suspended
2700 K / 10350 lm
3000 K / 10790 lm
220–240 V / 91 W
Push dim / DALI dim
3.0 kg

Art. No. / EAN code / Price VAT excluded

224S2S02272	13310 SEK
224S2S05272	13310 SEK

Art. No. / EAN code / Price VAT excluded

224S2S02302	13310 SEK
224S2S05302	13310 SEK

Art. No. / EAN code / Price VAT excluded

DR-0601 / 7330492000510	2145 SEK
-------------------------	----------

s1 r
Ceiling suspended
2700 K / 10350 lm
3000 K / 10790 lm
220–240 V / 91 W
Push dim / DALI dim
2.8 kg

Art. No. / EAN code / Price VAT excluded

224S1R02272	13090 SEK
224S1R05272	13090 SEK
224S1R20272	13090 SEK

Art. No. / EAN code / Price VAT excluded

224S1R02302	13090 SEK
224S1R05302	13090 SEK
224S1R20302	13090 SEK

Art. No. / EAN code / Price VAT excluded

DR-0601 / 7330492000510	2145 SEK
-------------------------	----------

s2 r
Ceiling suspended
2700 K / 10350 lm
3000 K / 10790 lm
220–240 V / 91 W
Push dim / DALI dim
3.0 kg

Art. No. / EAN code / Price VAT excluded

224S2R02272	13310 SEK
224S2R05272	13310 SEK
224S2R20272	13310 SEK

Art. No. / EAN code / Price VAT excluded

224S2R02302	13310 SEK
224S2R05302	13310 SEK
224S2R20302	13310 SEK

Art. No. / EAN code / Price VAT excluded

DR-0601 / 7330492000510	2145 SEK
-------------------------	----------

## w225 lon p4040

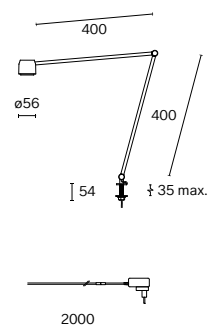

## Technical information

<b>Physical</b>	
<b>Material</b>	Lamp body & wall bracket: aluminium Base & pin: steel
<b>Optics</b>	Glare shade: polyamide Lens: polycarbonate
<b>IP rating</b>	20
<b>Protection class</b>	III

<b>LED</b>	
<b>Light source</b>	COB LED (included)
<b>Lifetime expectancy</b>	L80 / 50,000 h
<b>CRI Colour rendering index</b>	97
<b>Stand. deviation of colour</b>	3-step MacAdam
Replaceable by a professional	

## Article-specific information

<b>Version</b>	p4040
<b>Mounting</b>	Pin – integrated (hole ø 14 mm)
<b>LED Colour temperature (CCT) / Luminous flux</b>	3000 K / 439 lm
<b>Voltage / System power</b>	100–240 V / 6.3 W
<b>Beam angle / Optics</b>	Wide / Lens
<b>Light control</b>	Dimmable
<b>Net weight</b>	0.3 kg

<b>Colour</b>	
<b>Traffic white</b>	<input type="checkbox"/>
<b>Jet black</b>	<input checked="" type="checkbox"/>
<b>Raw tumbled</b>	<input checked="" type="checkbox"/>

<b>Accessories</b>	
<b>Adapter suitable for USM Haller Table</b>	
<b>Adapter suitable for USM Haller Shelf</b>	
<b>Adapter suitable for Vitra Joyn 2</b>	
<b>Adapter suitable for Vitra Tyde 2</b>	

<b>Art. No. / EAN code / Price VAT excluded</b>		
<b>225P40400230W</b> / 7330492000565		<b>3795 SEK</b>
<b>225P40400530W</b> / 7330492000572		<b>3795 SEK</b>
<b>225P40402030W</b> / 7330492001852		<b>3795 SEK</b>

<b>Art. No. / EAN code / Price VAT excluded</b>		
<b>225ACC001</b> / 7330492002002		<b>253 SEK</b>
<b>225ACC006</b> / 7330492002019		<b>253 SEK</b>
<b>225ACC002</b> / 7330492002026		<b>253 SEK</b>
<b>225ACC003</b> / 7330492002033		<b>253 SEK</b>

---

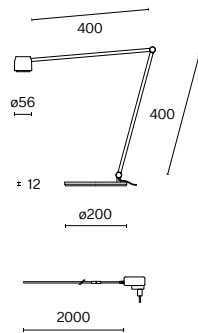
**w225 lon b4040**



---

b4040
Base
3000K / 439lm
100–240V / 6.3W
Wide / Lens
Dimmable
1.7 kg

---

**Art. No. / EAN code / Price VAT excluded**

---

<b>225B40400230W / 7330492000541</b>	<b>4675 SEK</b>
<b>225B40400530W / 7330492000558</b>	<b>4675 SEK</b>
<b>225B40402030W / 7330492001845</b>	<b>4675 SEK</b>

---

**Art. No. / EAN code / Price VAT excluded**

---

---

## w225 lon br0

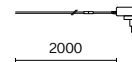
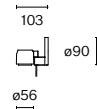

## Technical information

<b>Physical</b>	
<b>Material</b>	Lamp body & wall bracket: aluminium Base & pin: steel
<b>Optics</b>	Glare shade: polyamide Lens: polycarbonate
<b>IP rating</b>	20
<b>Protection class</b>	III

<b>LED</b>	
<b>Light source</b>	COB LED (included)
<b>Lifetime expectancy</b>	L80 / 50,000 h
<b>CRI Colour rendering index</b>	97
<b>Stand. deviation of colour</b>	3-step MacAdam
<b>Replaceable by a professional</b>	

## Article-specific information

<b>Version</b>	br0
<b>Mounting</b>	Wall bracket
<b>LED Colour temperature (CCT) / Luminous flux</b>	2700 K / 308 lm 3000 K / 405 lm
<b>Voltage / System power</b>	100–240 V / 6.3 W
<b>Beam angle / Optics</b>	Narrow / Lens
<b>Light control</b>	Dimmable
<b>Net weight</b>	0.2 kg

<b>2700 K Colour temperature (CCT)</b>	
<b>Traffic white</b>	<input type="radio"/>
<b>Jet black</b>	<input checked="" type="radio"/>
<b>Raw tumbled</b>	<input type="radio"/>

<b>3000 K Colour temperature (CCT)</b>	
<b>Traffic white</b>	<input type="radio"/>
<b>Jet black</b>	<input checked="" type="radio"/>
<b>Raw tumbled</b>	<input type="radio"/>

<b>Art. No. / EAN code / Price VAT excluded</b>	
<b>225BR00227N / 7330492000664</b>	<b>2475 SEK</b>
<b>225BR00527N / 7330492000671</b>	<b>2475 SEK</b>
<b>225BR02030N / 7330492001890</b>	<b>2475 SEK</b>

<b>Art. No. / EAN code / Price VAT excluded</b>	
<b>225BR00230N / 7330492000640</b>	<b>2475 SEK</b>
<b>225BR00530N / 7330492000657</b>	<b>2475 SEK</b>
<b>225BR02027N / 7330492001906</b>	<b>2475 SEK</b>



w225 lon br4040

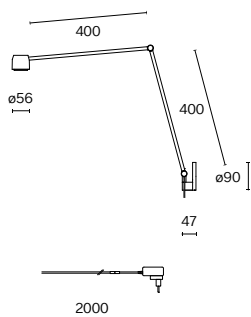
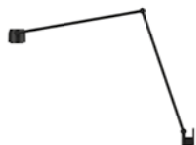

w225 lon b9040

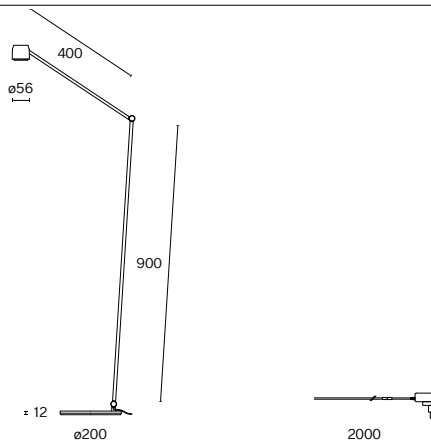

br4040
Wall bracket
3000 K / 439 lm
100–240 V / 6.3 W
Wide / Lens
Dimmable
0.4 kg

Art. No. / EAN code / Price VAT excluded

Art. No. / EAN code / Price VAT excluded

225BR40400230W / 7330492000626	3685 SEK
225BR40400530W / 7330492000633	3685 SEK
225BR40402030W / 7330492001883	3685 SEK

b9040
Base
2700 K / 308 lm
3000 K / 405 lm
100–240 V / 6.3 W
Narrow / Lens
Dimmable
1.8 kg

Art. No. / EAN code / Price VAT excluded

225B90400227N / 7330492000602	5225 SEK
225B90400527N / 7330492000619	5225 SEK

Art. No. / EAN code / Price VAT excluded

225B90400230N / 7330492000589	5225 SEK
225B90400530N / 7330492000596	5225 SEK

## w181 Linier

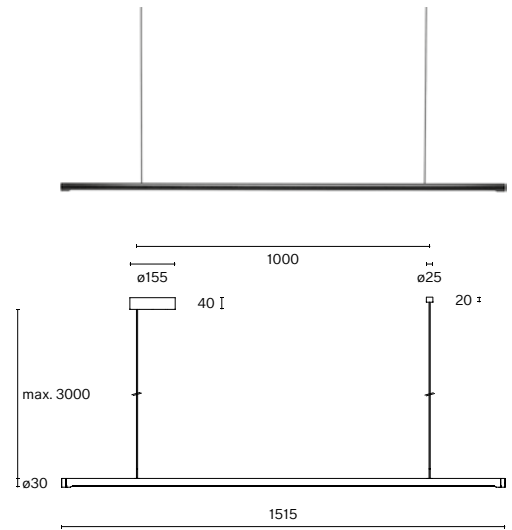

## Technical information

<b>Physical</b>	
<b>Material</b>	Lamp body: aluminium Canopy & bracket: ABS
<b>Optics</b>	Louvre: polyamide Lens: PMMA
<b>IP rating</b>	20
<b>Protection class</b>	II

<b>LED</b>	
<b>Light source</b>	Integrated LED
<b>Lifetime expectancy</b>	L80 / 50,000 h
<b>CRI Colour rendering index</b>	≥ 90
<b>Stand. deviation of colour</b>	3-step MacAdam
<b>Replaceable by a professional</b>	

## Article-specific information

<b>Mounting</b>	
<b>LED Colour temperature (CCT) / Luminous flux</b>	
<b>Voltage / System power</b>	
<b>Light control</b>	
<b>Net weight</b>	

<b>2700 K Colour temperature (CCT)</b>	
<b>Jet black</b>	●

<b>3000 K Colour temperature (CCT)</b>	
<b>Jet black</b>	●

<b>4000 K Colour temperature (CCT)</b>	
<b>Jet black</b>	●

<b>Ceiling suspended</b>	
2700 K / 2205 lm	
3000 K / 2205 lm	
4000 K / 2380 lm	
220–240 V / 60 W	
DALI dim-Push dim / Integrated rotary dimmer	
1.7 kg	

<b>Art. No. / EAN code / Price VAT excluded</b>	
<b>181S152705 / 7330492000121</b>	<b>9020 SEK</b>

<b>Art. No. / EAN code / Price VAT excluded</b>	
<b>181S153005 / 7330492000138</b>	<b>9020 SEK</b>

<b>Art. No. / EAN code / Price VAT excluded</b>	
<b>181S154005 / 7330492000145</b>	<b>9020 SEK</b>

<b>UGR</b>	<b>cd/m<sup>2</sup></b>
≤ 19	≤ 3000

## w181 Linier pro s1

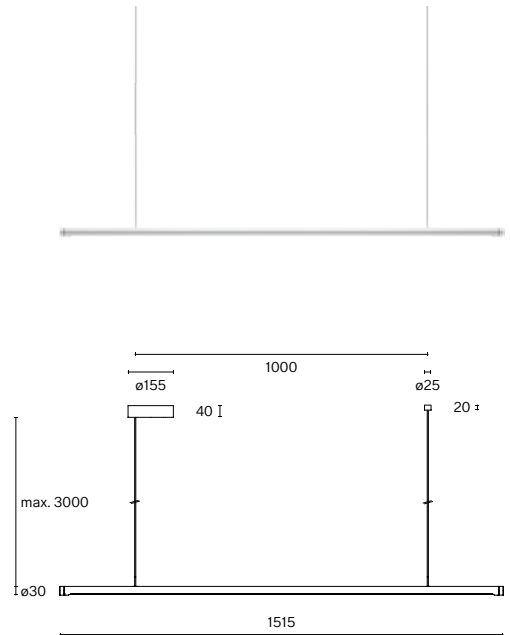

## Technical information

<b>Physical</b>	
<b>Material</b>	Lamp body: aluminium Canopy & bracket: ABS
<b>Optics</b>	Louvre: polyamide Lens: PMMA
<b>IP rating</b>	20
<b>Protection class</b>	II

<b>LED</b>	
<b>Light source</b>	Integrated LED
<b>Lifetime expectancy</b>	L80 / 50,000 h
<b>CRI Colour rendering index</b>	≥ 90
<b>Stand. deviation of colour</b>	3-step MacAdam
<b>Replaceable by a professional</b>	

## Article-specific information

<b>Version</b>	pro s1
<b>Mounting</b>	Ceiling suspended
<b>LED Colour temperature (CCT) / Luminous flux</b>	3000 K / 2720 lm 4000 K / 2720 lm
<b>Voltage / System power</b>	220–240 V / 60 W
<b>Light control</b>	DALI dim-Push dim
<b>Net weight</b>	1.7 kg

### 3000 K Colour temperature (CCT)

<b>Traffic white</b>	<input type="radio"/>
<b>Jet black</b>	<input checked="" type="radio"/>

### 4000 K Colour temperature (CCT)

<b>Traffic white</b>	<input type="radio"/>
<b>Jet black</b>	<input checked="" type="radio"/>

<b>Art. No. / EAN code / Price VAT excluded</b>	
<b>181PS123002 / 7330492002101</b>	<b>7590 SEK</b>
<b>181PS123005 / 7330492002088</b>	<b>7590 SEK</b>

### Art. No. / EAN code / Price VAT excluded

<b>181PS124002 / 7330492002118</b>	<b>7590 SEK</b>
<b>181PS124005 / 7330492002095</b>	<b>7590 SEK</b>

### Art. No. / EAN code / Price VAT excluded

<b>181PS124002 / 7330492002118</b>	<b>7590 SEK</b>
<b>181PS124005 / 7330492002095</b>	<b>7590 SEK</b>

<b>UGR</b>	<b>cd/m<sup>2</sup></b>
≤ 19	≤ 3000

## w181 Linier pro s2

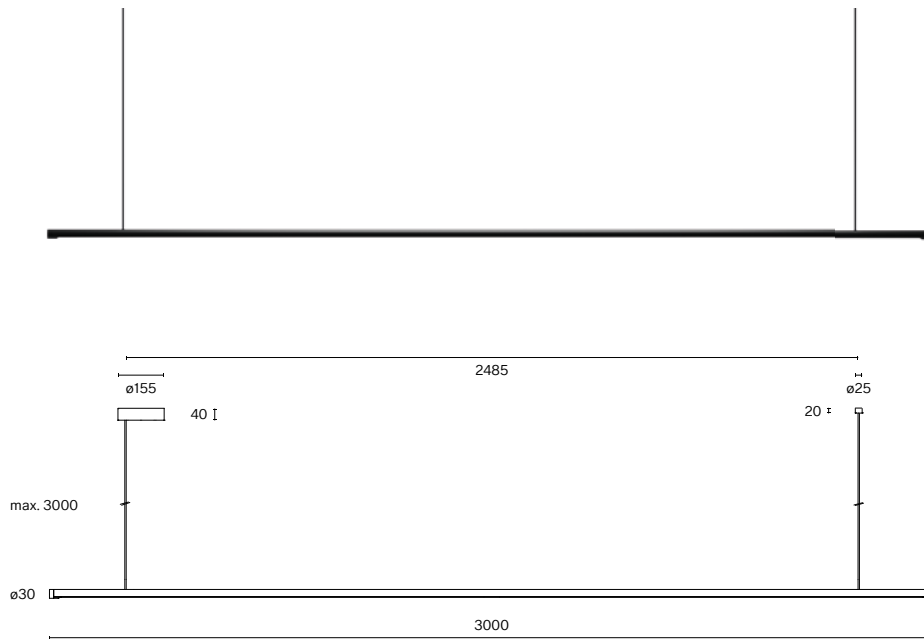

pro s2
Ceiling suspended
3000 K / 2720 lm
4000 K / 2720 lm
220–240 V / 60 W
DALI dim-Push dim
2.7 kg

## Art. No. / EAN code / Price VAT excluded

181PS223002 / 7330492002149	14300 SEK
181PS223005 / 7330492002125	14300 SEK

## Art. No. / EAN code / Price VAT excluded

181PS224002 / 7330492002156	14300 SEK
181PS224005 / 7330492002132	14300 SEK

## w127 Winkel b2

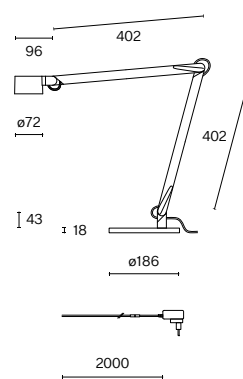

## Technical information

<b>Physical</b>	
<b>Material</b>	Lamp body, shade & glare shade: solid biopolyamide Heat sink: aluminium Base/clamp: solid biopolyamide & steel Wall/Rail bracket: aluminium Pin: stainless steel
<b>Optics</b>	Diffuser & reflector: polycarbonate
<b>IP rating</b>	20
<b>Protection class</b>	III

### LED

<b>Light source</b>	COB LED (included)
<b>Lifetime expectancy</b>	L80 / 50,000 h
<b>CRI Colour rendering index</b>	97
<b>Stand. deviation of colour</b>	3-step MacAdam
<b>Replaceable by a professional</b>	

## Article-specific information

<b>Version</b>	b2
<b>Mounting</b>	Base
<b>LED Colour temperature (CCT) / Luminous flux</b>	3000 K / 497 lm
<b>Voltage / System power</b>	100–240 V / 8.2 W
<b>Light control</b>	Integrated dimmer switch
<b>Net weight</b>	2.4 kg

### Colour

<b>White</b>	
<b>Black</b>	
<b>Grey</b>	

### Accessories

<b>Adapter suitable for Vitra AdHoc</b>	
<b>Adapter suitable for Vitra CDS &amp; Joyn</b>	
<b>Adapter suitable for Vitra Tyde</b>	

<b>Art. No. / EAN code / Price VAT excluded</b>		
<b>127B202 / 7330492006277</b>		<b>5445 SEK</b>
<b>127B205 / 7330492006291</b>		<b>5445 SEK</b>
<b>127B204 / 7330492006284</b>		<b>5445 SEK</b>

### Art. No. / EAN code / Price VAT excluded

w127 Winkel c2



w127 Winkel p2

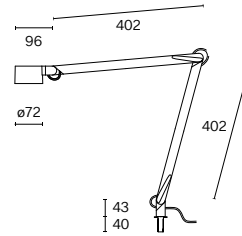
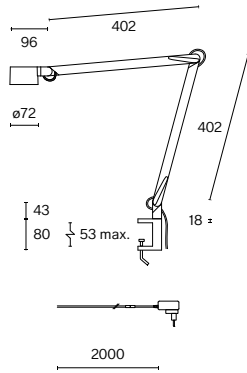

c2
Clamp
3000 K / 497 lm
100–240 V / 8.2 W
Integrated dimmer switch
0.8 kg

**Art. No. / EAN code / Price VAT excluded**

<b>127C202 / 7330492006314</b>	<b>5060 SEK</b>
<b>127C205 / 7330492006338</b>	<b>5060 SEK</b>
<b>127C204 / 7330492006321</b>	<b>5060 SEK</b>

**Art. No. / EAN code / Price VAT excluded**

p2
Pin – integrated (hole ø 12 mm)
3000 K / 497 lm
100–240 V / 8.2 W
Integrated dimmer switch
0.6 kg

**Art. No. / EAN code / Price VAT excluded**

<b>127P202 / 7330492006352</b>	<b>4785 SEK</b>
<b>127P205 / 7330492006376</b>	<b>4785 SEK</b>
<b>127P204 / 7330492006369</b>	<b>4785 SEK</b>

**Art. No. / EAN code / Price VAT excluded**

<b>127-PVI01</b>	<b>253 SEK</b>
<b>127-PVI02</b>	<b>253 SEK</b>
<b>127-PVI03</b>	<b>253 SEK</b>

## w227 Winkel alu p

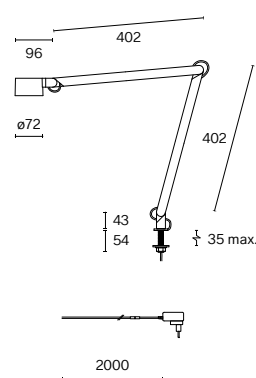

## Technical information

<b>Physical</b>	
<b>Material</b>	Lamp body: aluminium Base & pin: steel
<b>Optics</b>	Diffuser: acrylic Reflector & glare shade: polyamide
<b>IP rating</b>	20
<b>Protection class</b>	III
<b>LED</b>	
<b>Light source</b>	COB LED (included)
<b>Lifetime expectancy</b>	L80 / 50,000 h
<b>CRI Colour rendering index</b>	97
<b>Stand. deviation of colour</b>	3-step MacAdam
<b>Replaceable by a professional</b>	

## Article-specific information

<b>Version</b>	
<b>Mounting</b>	p
<b>LED Colour temperature (CCT) / Luminous flux</b>	3000 K / 497 lm
<b>Voltage / System power</b>	100–240 V / 8.2 W
<b>Light control</b>	Integrated dimmer switch (timer 8h)
<b>Net weight</b>	0.5 kg
<b>Colours</b>	
<b>Traffic white</b>	<input type="radio"/>
<b>Jet black</b>	<input checked="" type="radio"/>
<b>Accessories</b>	
<b>Adapter suitable for Vitra AdHoc</b>	
<b>Adapter suitable for Vitra CDS &amp; Joyn</b>	
<b>Adapter suitable for Vitra Tyde</b>	

<b>Art. No. / EAN code / Price VAT excluded</b>
<b>227P20230 / 7330492000725</b> <b>3025 SEK</b>
<b>227P20530 / 7330492000732</b> <b>3025 SEK</b>

<b>Art. No. / EAN code / Price VAT excluded</b>
<b>127-PVI01</b> <b>253 SEK</b>
<b>127-PVI02</b> <b>253 SEK</b>
<b>127-PVI03</b> <b>253 SEK</b>

## w227 Winkel alu b

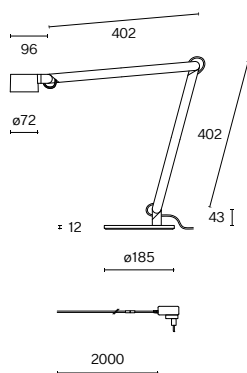

b
Base
3000 K / 497 lm
100–240 V / 8.2 W
Integrated dimmer switch (timer 8h)
4.0 kg

## Art. No. / EAN code / Price VAT excluded

227B20230 / 7330492000701	3630 SEK
227B20530 / 7330492000718	3630 SEK

## Art. No. / EAN code / Price VAT excluded
