

Magnus Olesen Produktlista 1

23%

Statligt ramavtal Möbler och inredning

Delområde B - Möten och paus | Ramavtalsnummer 23.3-5834-2022:006



23% rabatt ska dras av på angivna priser

FREYA SERIES

DESIGN: SAYS WHO

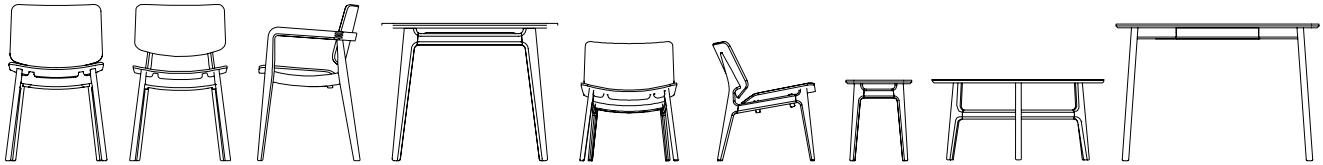

The popular Freya series consists of several furniture products. The design of the Freya series is rooted in classic Danish furniture design but interpreted for present standards. A modern wooden series with an astonishing abundance of understated details, highlighting the high degree of craftsmanship in the Freya series.

WOOD & TREATMENTS

See product details on the individual product pages



Oak, transparent lacquer
Oak, natural oil
Oak, white-oil
Oak, soap treatment
Oak, black-stained

LINOLEUM



Pebble 4175 NCS 3502-Y
Ash 4132 NCS 5502-G
Black 4023 NCS 9000-N

LAMINATE



Grey U1115 W Duopal NCS S4502-G
White F7949 Soft white Formica RAL 9016
Graphite F7837 Graphite Formica RAL8019
Wood pattern oak F 5374 Elegant oak Formica

RECOMMENDED FABRIC, LEATHER & ARTIFICIAL LEATHER

| GROUP A | GROUP B | GROUP C | LEATHER 1 | LEATHER 2 |
|--------------------------|--------------------------|---------------|--------------|----------------|
| Valencia, Main Line Plus | Atlas, Remix 3, Illusion | Steelcut Trio | Hero, Sydney | Savanne, Dunes |

See the overview of fabric, leather and artificial leather on page 89

CERTIFICATIONS



EU Ecolabel certification on specific products:

Freya (4711)
Freya Armrest (4714)
Freya Lounge (4731)
Freya Lounge with seat and back upholstery (4711)

EU Ecolabel: DK/049/016

23% rabatt ska dras av på angivna priser

FREYA

DESIGN: (2016) SAYS WHO

SPECIFICATIONS & MEASUREMENTS

Description The chair appears modern with its dynamic lines and elegant profile. It is a beautiful chair with great seating comfort.

Measurement W50 x D50 x H79 x SH46 cm

Weight Gross/Net: 7,5/7 kg/pc. 2 pcs/cart. 0,37 cbm/cart

Seat and back Laminated plywood with oak veneer

Frame Solid oak



FREYA

| Item No. | Product | Without upholstery | A | B | C | 1 | 2 |
|----------|--|--------------------|-------|-------|--------|--------|--------|
| MO 4711 | Seat and back in oak | 6.660 | | | | | |
| MO 4711 | Back in oak, seat upholstered | | 7.750 | 8.095 | 8.545 | 8.820 | 9.270 |
| MO 4711 | Fully upholstered seat and front side upholstered back | | 8.660 | 9.575 | 10.695 | 11.385 | 12.535 |

ADDITIONAL PURCHASE

| Item No. | Product | Price |
|----------|---|-------|
| | Frame, seat and back in black-stained oak | 835 |
| | Two buttons in front side upholstered back - same fabric as the back | 1.285 |
| | Two buttons in front side upholstered back in Savanne leather in selected colours | 1.660 |

ACCESSORIES

| Item No. | Product | Price |
|----------|----------------------------------|-------|
| MO 1617 | 4 pcs. felt glides, white | 185 |
| MO 1638 | 4 pcs. teflon glides | 200 |
| MO 1639 | 2 built-in castors in front legs | 2.000 |

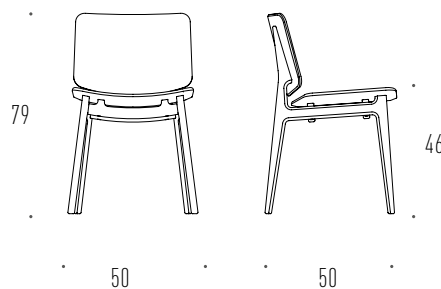

23% rabatt ska dras av på angivna priser

FREYA TWO

DESIGN: (2019) SAYS WHO

SPECIFICATIONS & MEASUREMENTS

Description Elegant chair with a more narrow back. The Freya Two chair still looks modern with its dynamic alignment and same elegant profile as Freya chair.

Measurement W50 x D50 x H79 x SH46 cm

Weight Gross/Net: 7,5/7 kg/pc. 2 pcs/cart. 0,37 cbm/cart

Seat and back Laminated plywood with oak veneer

Frame Solid oak



FREYA TWO

| Item No. | Product | Without Upholstery | A | B | C | 1 | 2 |
|----------|--|--------------------|-------|-------|--------|--------|--------|
| MO 4710 | Seat and back in oak | 6.470 | | | | | |
| MO 4710 | Back in oak, seat upholstered | | 7.400 | 7.745 | 8.195 | 8.470 | 8.920 |
| MO 4710 | Fully upholstered seat and front side upholstered back | | 8.310 | 9.225 | 10.345 | 11.035 | 12.185 |

ADDITIONAL PURCHASE

| Item No. | Product | Price |
|----------|---|-------|
| | Frame, seat and back in black-stained oak | 835 |
| | Two buttons in front side upholstered back - same fabric as the back | 1.285 |
| | Two buttons in front side upholstered back in Savanne leather in selected colours | 1.660 |

ACCESSORIES

| Item No. | Product | Price |
|----------|----------------------------------|-------|
| MO 1617 | 4 pcs. felt glides, white | 185 |
| MO 1638 | 4 pcs. teflon glides | 200 |
| MO 1639 | 2 built-in castors in front legs | 2.000 |

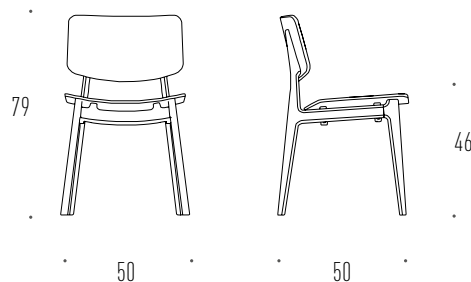

23% rabatt ska dras av på angivna priser

FREYA ARM

DESIGN: (2019) SAYS WHO

SPECIFICATIONS & MEASUREMENTS

| | |
|----------------------|--|
| Description | Elegant chair with armrest for extra good seating comfort. The chair appears modern with its dynamic design and same profile as Freya and Freya Two. |
| Measurement | W60 x D58 x H79 x SH46 cm |
| Weight | Gross/Net: 10/8 kg/pc. 1 pcs/cart. 0,37 cbm/cart |
| Seat and back | Laminated plywood with oak veneer |
| Frame | Solid oak |
| Stackable | 6 pcs. Measurement: B60 x D80 x H111 cm |



FREYA ARM CHAIR

| Item No. | Product | Without upholstery | A | B | C | 1 | 2 |
|----------|--|--------------------|--------|--------|--------|--------|--------|
| MO 4714 | Seat and back in oak | 11.645 | | | | | |
| MO 4714 | Back in oak, seat upholstered | | 12.575 | 12.910 | 13.370 | 13.635 | 14.095 |
| MO 4714 | Fully upholstered seat and front side upholstered back | | 13.485 | 14.400 | 15.520 | 16.200 | 17.360 |

ADDITIONAL PURCHASE

| Item No. | Product | Prize |
|----------|---|-------|
| | Frame, seat and back in black-stained oak | 835 |
| | Two buttons in front side upholstered back - same fabric as the back | 1.285 |
| | Two buttons in front side upholstered back in Savanne leather in selected colours | 1.660 |

ACCESSORIES

| Item No. | Product | Prize |
|----------|----------------------------------|-------|
| MO 1617 | 4 pcs. felt glides, white | 185 |
| MO 1638 | 4 pcs. teflon glides | 200 |
| MO 1639 | 2 built-in castors in front legs | 2.000 |

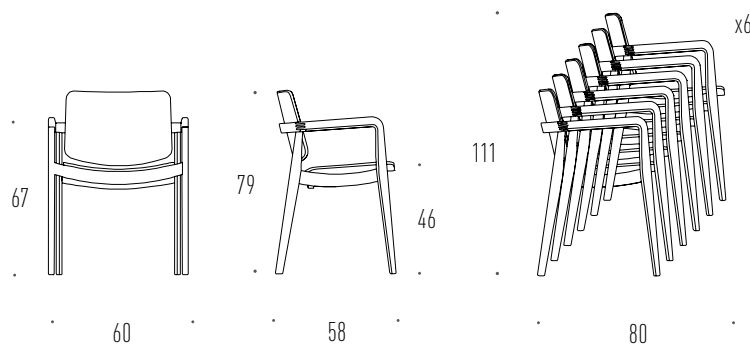

23% rabatt ska dras av på angivna priser

FREYA LOUNGE

DESIGN: (2017) SAYS WHO

SPECIFICATIONS & MEASUREMENTS

Description Its lower height and wide seat combined with the lounge slope gives the chair great seating comfort.

Measurement W60 x D62 x H72 x SH43 cm

Weight Gross/Net: 11/9 kg/pc. 1pcs/cart. 0.35/ cbm/cart

Seat and back Laminated plywood with oak veneer

Frame Solid oak



FREYA LOUNGE

| Item No. | Product | Without upholstery | A | B | C | 1 | 2 |
|----------|--|--------------------|--------|--------|--------|--------|--------|
| MO 4731 | Chair in oak | 12.835 | | | | | |
| MO 4731 | Seat and back with linoleum | 16.360 | | | | | |
| MO 4731 | Seat upholstered | | 13.985 | 14.545 | 15.285 | 15.750 | 16.520 |
| MO 4731 | Fully upholstered seat and front side upholstered back | | 15.245 | 16.360 | 17.695 | 18.525 | 19.870 |

ADDITIONAL PURCHASE

| Item No. | Product | Price |
|----------|---|-------|
| | Black-stained frame, seat and back | 835 |
| | Black-stained frame, back and upholstered seat | 585 |
| | Back in oak with linoleum, upholstered seat, and frame in oak | 1.770 |
| | Back in black-stained oak with linoleum, upholstered seat, and frame in black-stained oak | 1.770 |
| | 1 stitching in the back | 1.170 |

ACCESSORIES

| Item No. | Product | Price |
|----------|---------------------------|-------|
| MO 1617 | 4 pcs. felt glides, white | 185 |
| MO 1638 | 4 pcs. teflon glides | 200 |

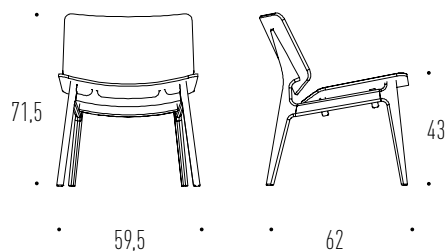

23% rabatt ska dras av på angivna priser

BUTTERFLY SERIES

DESIGN: NIELS GAMMELGAARD

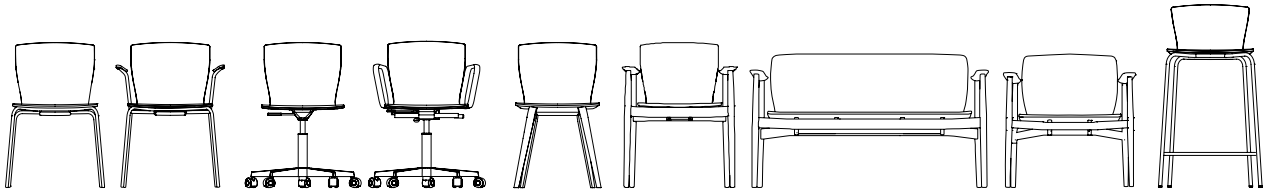

The Butterfly Series consists of 9 variants that offer a multitude of combinations with different kind of frames, wooden surfaces, and fabric variants. The chairs have a high seating comfort and elegant lightweight, yet distinctive and slim design. The seat shape and ease of the design resemble a butterfly, hence the name of these designer chairs.

WOOD & TREATMENTS

See product details on the individual product pages



Oak,
transparent
lacquer

Oak, black-
stained

STEEL & ALUMINUM COLOURS



Steel, bright
chrome

Steel, powder
lacquered in
matt, black
grained
lacquer

Polished
aluminium

Aluminium in
matt, black
grained lacquer

RECOMMENDED FABRIC, LEATHER & ARTIFICIAL LEATHER

| GROUP A | GROUP B | GROUP C | LEATHER 1 | LEATHER 2 |
|----------------------|-------------------------|-----------------------------------|--------------|-----------|
| Cura, Main Line Plus | Haku, Illusion, Remix 3 | Hallingdal 65, Steelcut Trio 3 | Sydney, Hero | Savanne |

See the overview of fabric, leather and artificial leather on page 89

CERTIFICATIONS



EU Ecolabel: DK/049/016

EU Ecolabel certification on specific products:

Butterfly Bar Chair (5314 + 5315)
Butterfly Wood (5340)
Butterfly Classic Chair (5351)
Butterfly Classic Lounge (5369/5379)
Butterfly (5310)

23% rabatt ska dras av på angivna priser

BUTTERFLY WITH 4 STEEL LEGS

DESIGN: (2013) NIELS GAMMELGAARD

SPECIFICATIONS & MEASUREMENTS

| | |
|----------------------|--|
| Description | Stackable chair with lumbar support and flexibility in the back. |
| Measurement | W53 x D53 x H79 x SH46 cm |
| Weight | Gross/Net: 6/5 kg/pc. 4 pcs/cart. 0,375 cbm/cart |
| Seat and back | Laminated plywood with oak veneer or black-stained or upholstery, fully or partially |
| Frame | Tubular steel - bright chrome or powder lacquered in matt, black grained lacquer |
| Stackable | Without upholstery: Floor: 12 pcs. Trolley: 20 pcs. With upholstery: Floor: 10 pcs. Trolley: 12-15 pcs. W55 x D95 x H130 cm (with 12 pcs.) |



BUTTERFLY WITH 4 STEEL LEGS

| Item No. | Product | Without upholstery | A | B | C | 1 | 2 |
|----------|------------------------|--------------------|-------|-------|-------|--------|--------|
| MO 5310 | Chair in oak | 4.185 | | | | | |
| MO 5310 | Upholstered seat | | 5.495 | 5.885 | 6.370 | 6.675 | 7.510 |
| MO 5310 | Fully upholstered | | 7.210 | 8.175 | 9.385 | 10.150 | 11.925 |
| MO 5310 | Front side upholstered | | 7.570 | 8.585 | 9.850 | 10.660 | 12.525 |

ADDITIONAL PURCHASE

| Item No. | Product | Price |
|----------|--|-------|
| | Chair in black-stained oak | 835 |
| | Channel stitchings, fully upholstered model | 2.200 |
| | Channel stitchings, front side upholstered model | 3.245 |

ACCESSORIES

| Item No. | Product | Price |
|----------|--|--------|
| MO 1306 | Hang-up bracket - single, in black plastic. Min. table length: 2 chairs 140 cm and 3 chairs 200 cm | 460 |
| MO 1154 | Trolley - Chairs without upholstery: 20 pcs. Chairs with upholstery: 12-15 pcs. | 19.625 |
| MO 1213 | Linking device - device: 9 cm | 835 |
| MO 1600 | 4 pcs. Loose, hard plastic glides, black (for soft floors) | 160 |
| MO 1601 | 4 pcs. Loose, less hard plastic glides, grey (for soft) | 160 |
| MO 1602 | 4 pcs. loose felt glides | 185 |

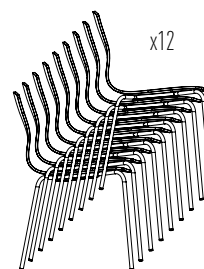
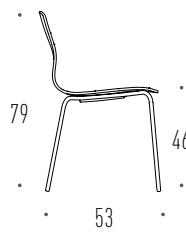
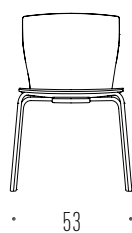

23% rabatt ska dras av på angivna priser

BUTTERFLY WITH 4 STEEL LEGS & ARMREST

DESIGN: (2013) NIELS GAMMELGAARD

SPECIFICATIONS & MEASUREMENTS

| | |
|----------------------|--|
| Description | Stackable chair with armrest and lumbar support and flexibility in the back. |
| Measurement | W53 x D53 x H79 x SH46 cm |
| Weight | Gross/Net: 6/5 kg/pc. 4 pcs/cart. 0,375 cbm/cart |
| Seat and back | Laminated plywood with oak veneer or black-stained or upholstery, fully or partially |
| Frame | Tubular steel: bright chrome or powder lacquered in matt, black grained lacquer Black PUR rubber - wooden armrests available at an additional price |
| Armrest | Without upholstery: Floor: 12 pcs. Trolley: 20 pcs. |
| Stackable | With upholstery: Floor: 10 pcs. Trolley: 12-15 pcs. Measurement with 12 pcs. W60 x D95 x H120 cm |



BUTTERFLY WITH 4 STEEL LEGS AND ARMREST

| Item No. | Product | Without upholstery | A | B | C | 1 | 2 |
|----------|------------------------|--------------------|-------|-------|--------|--------|--------|
| MO 5311 | Chair in oak | 5.375 | | | | | |
| MO 5311 | Upholstered seat | | 6.635 | 7.025 | 7.520 | 7.820 | 8.700 |
| MO 5311 | Fully upholstered | | 8.325 | 9.320 | 10.525 | 11.475 | 13.120 |
| MO 5311 | Front side upholstered | | 8.770 | 9.785 | 9.220 | 11.860 | 13.775 |

ADDITIONAL PURCHASE

| Item No. | Product | Price |
|----------|--|-------|
| | Chair in black-stained oak | 835 |
| | Armrest in wood, laquered or black-stained | 420 |
| | Channel stitchings, fully upholstered model | 2.200 |
| | Channel stitchings, front side upholstered model | 3.245 |

ACCESSORIES

| Item No. | Product | Price |
|----------|---|--------|
| MO 1306 | Hang-up bracket- single, in black plastic. Min. table length: 2 chairs 140 cm and 3 chairs 200 cm | 460 |
| MO 1154 | Trolley - Chairs without upholstery: 20 pcs. Chairs with upholstery: 10 pcs. | 19.625 |
| MO 1213 | Linking device - device: 9 cm | 835 |
| MO 1600 | 4 pcs. Loose, hard plastic glides, black (for soft floors) | 160 |
| MO 1601 | 4 pcs. Loose, less hard plastic glides, grey (for soft) | 160 |
| MO 1602 | 4 pcs. loose felt glides | 185 |

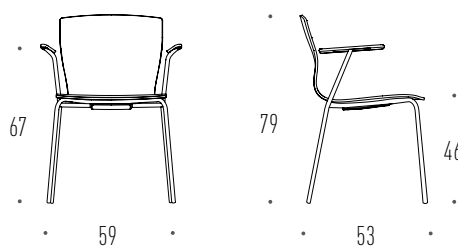

23% rabatt ska dras av på angivna priser

BUTTERFLY SWIVEL

DESIGN: NIELS GAMMELGAARD

SPECIFICATIONS & MEASUREMENTS

| | |
|----------------------|---|
| Description | Functional office chair without compromising on design. |
| Measurement | W64 x D55 x H77-95 x SH44-58 cm |
| Weight | Gross/Net: 13,9/11,9 kg/pc. 2 pcs/cart. 0,43 kbm kart. |
| Seat and back | Laminated plywood with oak veneer with upholstery |
| Frame | Polished aluminium and aluminium in matt, black grained lacquer |
| Model MO 5480 | Castors, flexible tilt, height adjustment |
| Model MO 5482 | Glides, flexible tilt, revolving, self centering |
| Model MO 5484 | Glides, flexible tilt, height adjustment |



BUTTERFLY SWIVEL

| Item No. | Product | A | B | C | 1 | 2 |
|---------------------|------------------------|-------|--------|--------|--------|--------|
| MO 5480, 5482, 5484 | Fully upholstered | 9.050 | 10.060 | 11.295 | 12.085 | 13.985 |
| MO 5480, 5482, 5484 | Front side upholstered | 9.500 | 10.560 | 11.860 | 12.695 | 14.685 |

ADDITIONAL PURCHASE

| Item No. | Product | Price |
|----------|---|-------|
| | Glides with felt | 370 |
| | Hard castors | 370 |
| | Frame and armrest in black, grained lacquer | 585 |
| | Narrow channel stitchings, fully upholstered version | 2.200 |
| | Narrow channel stitchings, front side upholstered version | 3.245 |

ACCESSORIES

| Item No. | Product | Price |
|----------|--|-------|
| MO 1306 | Hang-up bracket- single, in black plastic. Min. table length: 2 chairs 140 cm and 3 chairs 200 cm | 420 |
| MO 1507 | Writing tablet - tablet in plywood with white laminat, edge painted black. Steel arm in black lacquer. Rotateable, fixed on column | 3.660 |
| MO 1608 | 1 set (5 pcs.) plastic glides, hard (for soft floors) | 1.160 |
| MO 1609 | 1 set (5 pcs.) plastic glides with felt (for hard floors) | 1.160 |
| MO 1611 | 1 set (5 pcs.) soft castors (for hard floors) | 1.160 |
| MO 1622 | 1 set (5 pcs.) hard castors (for soft floors) | 1.160 |

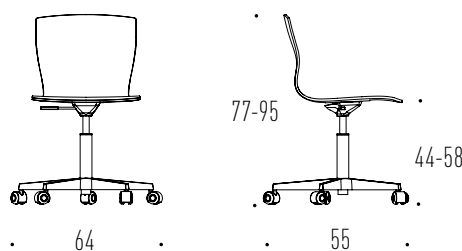

23% rabatt ska dras av på angivna priser

BUTTERFLY SWIVEL WITH ARMREST

DESIGN: (2013) NIELS GAMMELGAARD

SPECIFICATIONS & MEASUREMENTS

| | |
|---------------------------|---|
| Description | Functional office chair without compromising on design. |
| Measurement | W64 x D55 x H77-95 x SH44-58 cm |
| Weight | Gross/Net: 13,9/11,9 kg/pc. 1 pcs/cart. 0,35 kbm kart. |
| Seat and back | Laminated plywood with oak veneer with upholstery |
| Frame and armrests | Polished aluminium and aluminium in matt, black grained lacquer |
| Model MO 5481 | Castors, flexible tilt, height adjustment |
| Model MO 5483 | Glides, flexible tilt, revolving, self centering |
| Model MO 5485 | Glides, flexible tilt, height adjustment |



BUTTERFLY SWIVEL WITH ARMREST

| Item No. | Product | A | B | C | 1 | 2 |
|---------------------|------------------------|--------|--------|--------|--------|--------|
| MO 5481, 5483, 5485 | Fully upholstered | 11.935 | 12.945 | 14.175 | 14.970 | 16.870 |
| MO 5481, 5483, 5485 | Front side upholstered | 12.385 | 13.445 | 14.745 | 15.575 | 17.570 |

ADDITIONAL PURCHASE

| Item No. | Product | Price |
|----------|---|-------|
| | Glides with felt | 370 |
| | Hard castors | 370 |
| | Frame and armrest in black, grained lacquer | 585 |
| | Narrow channel stitchings, fully upholstered version | 2.200 |
| | Narrow channel stitchings, front side upholstered version | 3.245 |

ACCESSORIES

| Item No. | Product | Price |
|----------|---|-------|
| MO 1608 | 1 set (5 pcs.) plastic glides, hard (for soft floors) | 1.160 |
| MO 1609 | 1 set (5 pcs.) plastic glides with felt (for hard floors) | 1.160 |
| MO 1611 | 1 set (5 pcs.) soft castors (for hard floors) | 1.160 |
| MO 1622 | 1 set (5 pcs.) hard castors (for soft floors) | 1.160 |

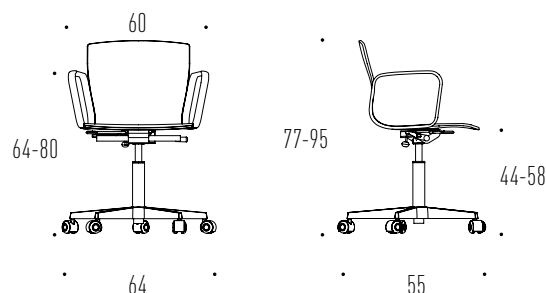

23% rabatt ska dras av på angivna priser

BUTTERFLY SWIVEL HIGH

DESIGN: (2016) NIELS GAMMELGAARD

SPECIFICATIONS & MEASUREMENTS

| | |
|----------------------|---|
| Description | Functional office chair without compromising on design. |
| Measurement | W64 x D55 x H85-103 x SH44-58 cm |
| Weight | Gross/Net: 13,5/11,5 kg/pc. 2 pcs/cart. 0,43 cbm/cart |
| Seat and back | Laminated plywood with oak veneer with upholstery |
| Frame | Polished aluminium and aluminium in matt, black grained lacquer |
| Model MO 5490 | Castors, flexible tilt, height adjustment |
| Model MO 5492 | Glides, flexible tilt, revolving, self centering |
| Model MO 5494 | Glides, flexible tilt, height adjustment |



BUTTERFLY SWIVEL HIGH

| Item No. | Product | A | B | C | 1 | 2 |
|---------------------|------------------------|--------|--------|--------|--------|--------|
| MO 5490, 5492, 5494 | Fully upholstered | 10.425 | 11.595 | 13.020 | 13.925 | 16.835 |
| MO 5490, 5492, 5495 | Front side upholstered | 10.950 | 12.175 | 13.670 | 14.625 | 17.675 |

ADDITIONAL PURCHASE

| Item No. | Product | Price |
|----------|---|-------|
| | Glides with felt | 370 |
| | Hard castors | 370 |
| | Frame and armrest in black, grained lacquer | 585 |
| | Wide channel stitchings, fully upholstered version | 2.200 |
| | Wide channel stitchings, front side upholstered version | 3.245 |

ACCESSORIES

| Item No. | Product | Price |
|----------|--|-------|
| MO 1306 | Hang-up bracket- single, in black plastic. Min. table length: 2 chairs 140 cm and 3 chairs 200 cm | 420 |
| MO 1507 | Writing tablet - tablet in plywood with white laminat, edge painted black. Steel arm in black lacquer. Rotateable, fixed on column | 3.660 |
| MO 1608 | 1 set (5 pcs.) plastic glides, hard (for soft floors) | 1.160 |
| MO 1609 | 1 set (5 pcs.) plastic glides with felt (for hard floors) | 1.160 |
| MO 1611 | 1 set (5 pcs.) soft castors (for hard floors) | 1.160 |
| MO 1622 | 1 set (5 pcs.) hard castors (for soft floors) | 1.160 |

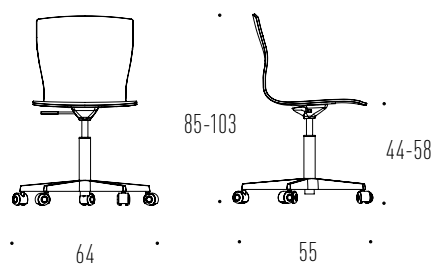

23% rabatt ska dras av på angivna priser

BUTTERFLY SWIVEL HIGH WITH ARM

DESIGN: (2016) NIELS GAMMELGAARD

SPECIFICATIONS & MEASUREMENTS

| | |
|---------------------------|---|
| Description | Functional office chair without compromising on design. |
| Measurement | W64 x D55 x H85-103 x SH44-58 cm |
| Weight | Gross/Net: 14,1/12,1 kg/pc. 1 pcs/cart. 0,35 cbm/cart |
| Seat and back | Laminated plywood with oak veneer with upholstery |
| Frame and armrests | Polished aluminium and aluminium in matt, black grained lacquer |
| Model MO 5491 | Castors, flexible tilt, height adjustment |
| Model MO 5493 | Glides, flexible tilt, revolving, self centering |
| Model MO 5495 | Glides, flexible tilt, height adjustment |



BUTTERFLY SWIVEL HIGH WITH ARMREST

| Item No. | Product | A | B | C | 1 | 2 |
|---------------------|------------------------|--------|--------|--------|--------|--------|
| MO 5491, 5493, 5495 | Fully upholstered | 13.310 | 14.475 | 15.900 | 16.810 | 19.720 |
| MO 5491, 5493, 5495 | Front side upholstered | 13.835 | 15.060 | 16.550 | 17.510 | 20.560 |

ADDITIONAL PURCHASE

| Item No. | Product | Price |
|----------|---|-------|
| | Glides with felt | 370 |
| | Hard castors | 370 |
| | Frame and armrest in black, grained lacquer | 585 |
| | Wide channel stitchings, fully upholstered version | 2.200 |
| | Wide channel stitchings, front side upholstered version | 3.245 |

ACCESSORIES

| Item No. | Product | Price |
|----------|---|-------|
| MO 1608 | 1 set (5 pcs.) plastic glides, hard (for soft floors) | 1.160 |
| MO 1609 | 1 set (5 pcs.) plastic glides with felt (for hard floors) | 1.160 |
| MO 1611 | 1 set (5 pcs.) soft castors (for hard floors) | 1.160 |
| MO 1622 | 1 set (5 pcs.) hard castors (for soft floors) | 1.160 |

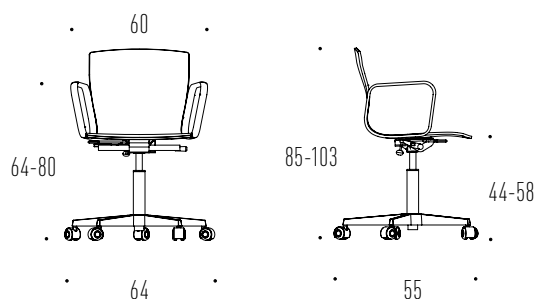

23% rabatt ska dras av på angivna priser

BUTTERFLY WOOD

DESIGN: (2013) NIELS GAMMELGAARD

SPECIFICATIONS & MEASUREMENTS

| | |
|----------------------|---|
| Description | Chair in Nordic design tradition with laminated wood shell and wood frame in Scandinavian oak. |
| Measurement | W46 x D52 x H79 x SH46 cm |
| Weight | Gross/Net: 5,4/4,9 kg/pc. 2 pcs/cart. 0,32 cbm/cart |
| Seat and back | Laminated plywood with oak veneer with transparent lacquer or black-stained or upholstery, fully or partially |
| Frame | Laminated wood with top veneer in oak with transparent lacquer or black-stained |



BUTTERFLY WOOD

| Item No. | Product | Without Upholstery | A | B | C | 1 | 2 |
|----------|------------------------|--------------------|-------|-------|-------|--------|--------|
| MO 5340 | Chair in oak | 4.995 | | | | | |
| MO 5340 | Upholstered seat | | 6.325 | 6.620 | 7.010 | 7.270 | 7.645 |
| MO 5340 | Fully upholstered | | 7.675 | 8.470 | 9.425 | 10.035 | 11.025 |
| MO 5340 | Front side upholstered | | 8.075 | 8.910 | 9.910 | 10.550 | 11.585 |

ADDITIONAL PURCHASE

| Item No. | Product | Price |
|----------|---|-------|
| | Chair in black-stained oak | 835 |
| | Frame in black-stained oak | 585 |
| | Narrow channel stitchings, fully upholstered version | 2.200 |
| | Narrow channel stitchings, front side upholstered version | 3.245 |

ACCESSORIES

| Item No. | Product | Price |
|----------|---|-------|
| MO 1306 | Hang-up bracket- single, in black plastic. Min. table length: 2 chairs 140 cm and 3 chairs 200 cm | 395 |
| MO 1612 | 4 pcs. loose felt glides, white | 185 |
| MO 1613 | 4 pcs. loose plastic glides, white | 200 |

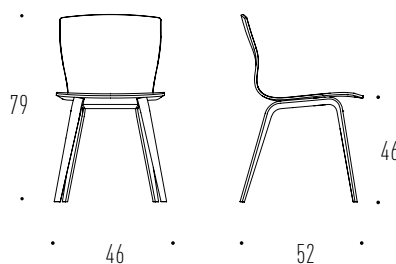

23% rabatt ska dras av på angivna priser

BUTTERFLY CLASSIC ARMCHAIR

DESIGN: (2018) NIELS GAMMELGAARD

SPECIFICATIONS & MEASUREMENTS

- Description** Exclusive and comfortable solution for dining tables as well as meeting tables, but also functions as an independent chair in classic design surroundings.
- Measurement** W63 x D52 x H80 x SH46 cm
- Weight** Gross/Net: 6,5/4,9 kg/pc. 1 pcs/cart. 0,33 cbm/cart
- Seat and back** Laminated plywood with oak veneer or black-stained or upholstery, fully or partially
- Frame and armrest** Solid wood with transparent lacquer or black-stained



BUTTERFLY CLASSIC ARMCHAIR

| Item No. | Product | Without upholstery | A | B | C | 1 | 2 |
|----------|------------------------|--------------------|--------|--------|--------|--------|--------|
| MO 5351 | Chair in oak | 7.625 | | | | | |
| MO 5351 | Fully upholstered | | 10.650 | 11.625 | 12.825 | 13.595 | 15.960 |
| MO 5351 | Front side upholstered | | 11.010 | 12.035 | 13.295 | 14.100 | 16.495 |

ADDITIONAL PURCHASE

| Item No. | Product | Price |
|----------|--|-------|
| | Chair in black-stained oak | 835 |
| | Frame and armrest in black-stained oak | 585 |

ACCESSORIES

| Item No. | Product | Price |
|----------|---------------------------|-------|
| MO 1617 | 4 pcs. felt glides, white | 185 |
| MO 1638 | 4 pcs. teflon glides | 200 |
| MO 1640 | 2 pcs. front castors | 2.000 |

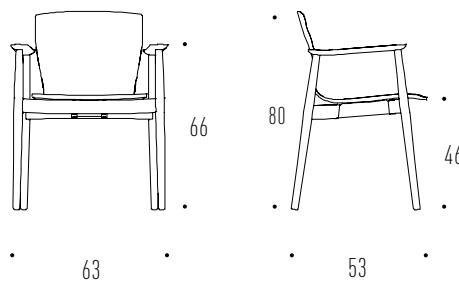

23% rabatt ska dras av på angivna priser

BUTTERFLY CLASSIC LOUNGE

DESIGN: (2018) NIELS GAMMELGAARD

SPECIFICATIONS & MEASUREMENTS

| | |
|--------------------------|---|
| Description | The low height and the wide seat give the chair exceptional comfort combined with the simple, beautiful design. |
| Measurement | W73 x D63 x H73/75 x SH39/43 cm |
| Weight | Gross/Net: 16/14 kg/pc. 1 pcs/cart. 0,45 cbm/cart |
| Model MO 5369 | Seat height: H73 x SH39 cm |
| Model MO 5379 | Seat height: H75 x SH43 cm |
| Seat and back | Laminated plywood with oak veneer or black-stained or upholstery, fully or partially |
| Frame and armrest | Solid wood with transparent lacquer or black-stained |



BUTTERFLY CLASSIC LOUNGE

| Item No. | Product | Without upholstery | A | B | C | 1 | 2 |
|------------------|------------------------|--------------------|--------|--------|--------|--------|--------|
| MO 5369, MO 5379 | Chair in oak | 16.660 | | | | | |
| MO 5369, MO 5379 | Fully upholstered | | 19.810 | 21.770 | 24.135 | 25.645 | 28.075 |
| MO 5369, MO 5379 | Front side upholstered | | 20.800 | 22.860 | 25.345 | 26.925 | 29.475 |

ADDITIONAL PURCHASE

| Item No. | Product | Price |
|----------|--|-------|
| | Chair in black-stained oak | 835 |
| | Frame and armrest in black-stained oak | 585 |

ACCESSORIES

| Item No. | Product | Price |
|----------|---------------------------|-------|
| MO 1617 | 4 pcs. felt glides, white | 185 |
| MO 1638 | 4 pcs. teflon glides | 200 |

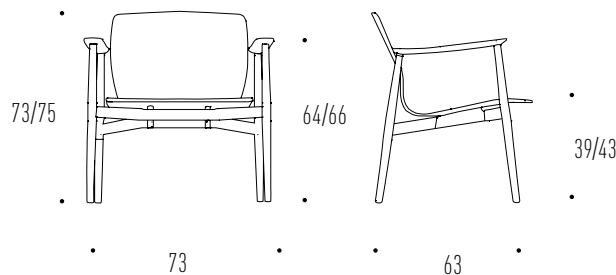

23% rabatt ska dras av på angivna priser

BUTTERFLY BAR

DESIGN: (2013) NIELS GAMMELGAARD

SPECIFICATIONS & MEASUREMENTS

| | |
|----------------------|--|
| Description | Stackable bar chair with lumbar support and flexibility in the back. |
| Measurement | W49 x D53 x H87/99 x SH65/77cm |
| Weight | Gross/Net: 6/5 kg/pc. 2 pcs/cart. 0,29 cbm/cart |
| Seat height | MO 5318: H87 x SH65 cm MO 5319: H99 x SH77 cm |
| Seat and back | Laminated plywood with oak veneer or black-stained or upholstery, fully or partially |
| Frame | Tubular steel - bright chrome or powder lacquered in matt, black grained lacquer |
| Stackable | 6 pcs. |



BUTTERFLY BAR

| Item No. | Product | Without upholstery | A | B | C | 1 | 2 |
|------------------|------------------------|--------------------|-------|--------|--------|--------|--------|
| MO 5318, MO 5319 | Chair in oak | 5.550 | | | | | |
| MO 5318, MO 5319 | Fully upholstered | | 8.760 | 9.735 | 10.945 | 11.710 | 12.935 |
| MO 5318, MO 5319 | Front side upholstered | | 9.225 | 10.245 | 11.510 | 12.320 | 12.375 |

ADDITIONAL PURCHASE

| Item No. | Product | Price |
|----------|----------------------------|-------|
| | Chair in black-stained oak | 1.050 |

ACCESSORIES

| Item No. | Product | Price |
|----------|--|-------|
| MO 1600 | 4 pcs. Loose, hard plastic glides, black (for soft floors) | 75 |
| MO 1601 | 4 pcs. Loose, less hard plastic glides, grey (for soft | 75 |
| MO 1602 | 4 pcs. loose felt glides | 185 |
| MO 1306 | Hang-up bracket- single, in black plastic. | 395 |

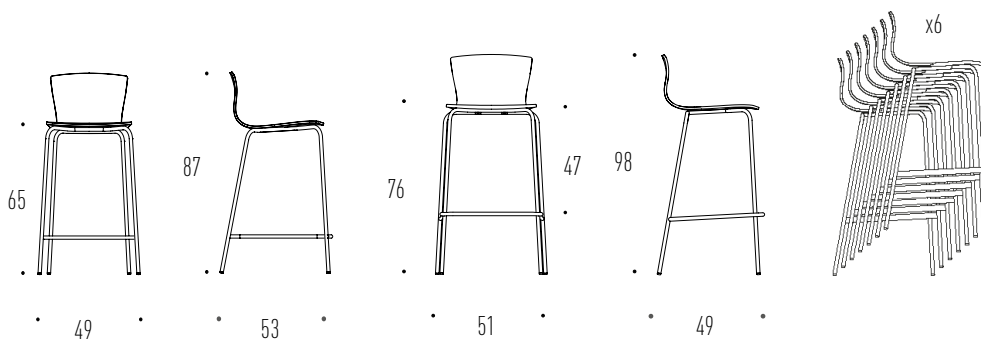

23% rabatt ska dras av på angivna priser

Ø CHAIR

DESIGN: (2020) ØIVIND SLAATTO



A chair in modular design consisting of three parts - seat, back and frame - elegantly combined with just one screw. This makes the chair easy to disassemble, so parts can be recycled and reused. The chair is created under the aspect of unique design, longevity and minimal transport costs due to the chairs stacking ability.

WOOD & TREATMENTS

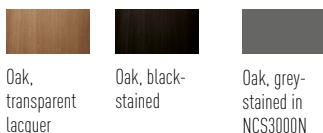

Oak, transparent lacquer

Oak, black-stained

Oak, grey-stained in NCS3000N

SPECIAL COLOURS ON SEAT AND BACK IN OAK

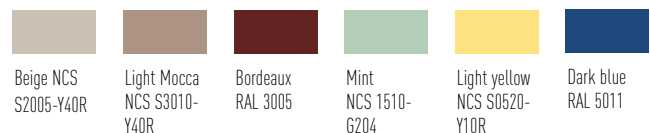

Beige NCS S2005-Y40R

Light Mocca NCS S3010-Y40R

Bordeaux RAL 3005

Mint NCS 1510-G204

Light yellow NCS S0520-Y10R

Dark blue RAL 5011

STANDARD STEEL COLOURS

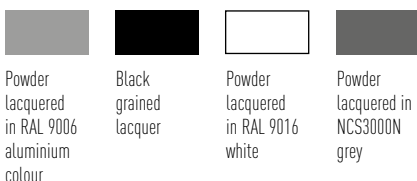

Powder lacquered in RAL 9006 aluminium colour

Black grained lacquer

Powder lacquered in RAL 9016 white

Powder lacquered in NCS3000N grey

SPECIAL STEEL COLOURS

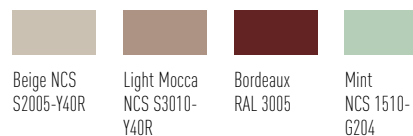

Beige NCS S2005-Y40R

Light Mocca NCS S3010-Y40R

Bordeaux RAL 3005

Mint NCS 1510-G204

STANDARD SCREW COLOURS

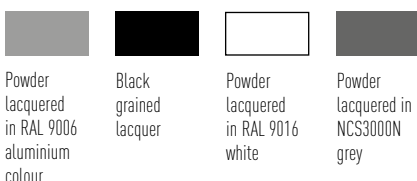

Powder lacquered in RAL 9006 aluminium colour

Black grained lacquer

Powder lacquered in RAL 9016 white

Powder lacquered in NCS3000N grey

SPECIAL SCREW COLOURS

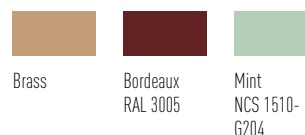

Brass

Bordeaux RAL 3005

Mint NCS 1510-G204

RECOMMENDED FABRIC, LEATHER & ARTIFICIAL LEATHER

| GROUP A | GROUP B | GROUP C | LEATHER 1 | LEATHER 2 |
|-----------|---|-----------------------------|--------------|-----------------|
| Cura, Era | Atlas, Remix 3, Main Line Flax, Illusion | Steel Trio 3, Hallingdal 65 | Hero, Sydney | Savanne, Vacona |

See the overview of fabric, leather and artificial leather on page 89

23% rabatt ska dras av på angivna priser

Ø CHAIR - 9 SELECTED VARIANTS

DESIGN: (2020) ØIVIND SLAATTO



Ø CHAIR - 9 SELECTED VARIANTS

| Item No. | Product | Description | Price |
|------------|-----------------------------|--|-------|
| MO 2030-L1 | CLASSIC - Wood/ White/ Grey | Frame: White. Seat: Oak w/transparent lacquer. Screw: Brass. Back: Grey | 4.995 |
| MO 2030-L2 | CLASSIC - Black Monochrome | Frame: Black grained lacquer.Seat: Oak, painted black. Screw: Black. Back: Oak, painted black | 4.950 |
| MO 2030-L3 | CLASSIC - Wood/ Wood/ White | Frame: White. Seat: Oak w/transparent lacquer. Screw: White. Back: Oak w/transparent lacquer | 4.950 |
| MO 2030-L4 | NATURE - Nature/ Leather | Frame: Beige. Seat: Upholstered in leather - Royal Nubuck Ecu 30253. Screw: Brass. Back: Light Mocca | 8.185 |
| MO 2030-L5 | NATURE - Nature | Frame: Mocca. Seat: Light. Mocca. Screw: Brass. Back: Beige | 5.870 |
| MO 2030-L6 | COLOURS - Cool Mint | Frame: Bordeaux. Seat: Mint. Screw: Brass. Back: Dark blue | 5.870 |
| MO 2030-L7 | COLOURS - Cool Mint Fabric | Frame: Mint. Seat: Upholstered - Atlas 911. Screw: Mint. Back: Oak w/transparent lacquer | 6.510 |
| MO 2030-L8 | COLOURS - Bordeaux Pang | Frame: Bordeaux. Seat: Upholstered - Atlas 661. Screw: Bordeaux. Back: Bordeaux | 6.660 |
| MO 2030-L9 | COLOURS - Pale Sun | Frame: Grey. Seat: Light yellow. Screw: Grey. Back: Oak w/transparent lacquer | 4.950 |

23% rabatt ska dras av på angivna priser

Ø CHAIR

DESIGN: (2020) ØIVIND SLAATTO

SPECIFICATIONS & MEASUREMENTS

Description A chair in a modular design with only 3 elements - back, seat and legs - assembled elegantly with one screw.

Measurement W50 x D53 x H80 x SH45 cm

Weight Gross/Net: 5,7/4,6 kg/pc. 5 pcs/cart. 0,375 cbm/cart

Stackable Without upholstery: 12 pcs.
With upholstery: 8 pcs.



Ø CHAIR

| Item No. | Product | Without upholstery | A | B | C | 1 | 2 |
|----------|---------------------------------------|--------------------|-------|-------|-------|-------|-------|
| MO 2030 | Chair in oak with transparent lacquer | 4.950 | | | | | |
| MO 2030 | Seat upholstered - with visible screw | | 5.785 | 6.485 | 7.410 | 7.960 | 8.850 |

ADDITIONAL PURCHASE

| Item No. | Product | Price |
|----------|------------------------------------|-------|
| | Frame colour - see page 40 | 185 |
| | Seat screw colour - see page 40 | 185 |
| | Seat and back colour - see page 40 | 185 |

*Available in selected special colors - when purchasing a minimum of 25 pcs. in the same color

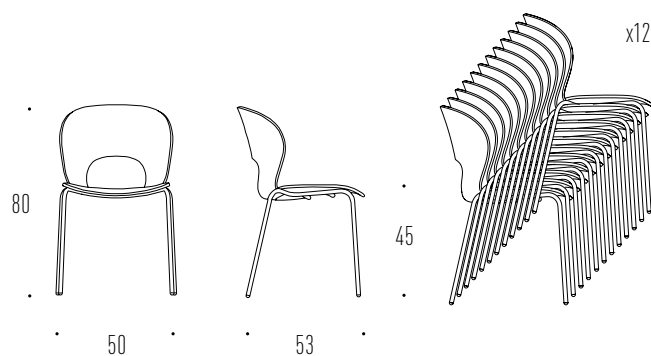

23% rabatt ska dras av på angivna priser

PAUSE

DESIGN: BUSK + HERTZOG

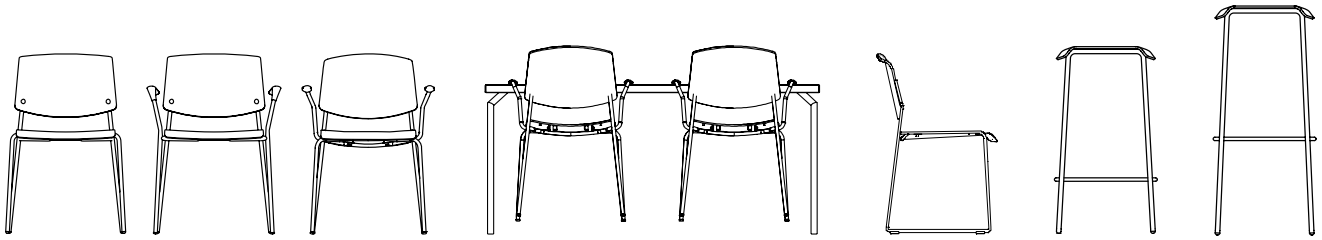

The Pause chair is designed to appear just as beautiful from the front as from behind. The expression is simple and light – like the chair that is easily stacked or put in rows. Available with or without arm rests pointing backwards or forward. Pause Bar Stool is also light and modern. The Pause chair series is also available with seat and back in a composite materiale.

WOOD & TREATMENTS



Oak,
transparent
lacquer

Oak, black-
stained

COMPOSITE COLOURS

See product details on the individual product pages



Brown grey
NCS S5005-
Y50R

Beige
NCS S2005-
Y30R

Black
NCS S9000-N

STEEL COLOURS



Tubular steel:
powder lacquer
in black, matt
grained lacquer

Tubular steel:
Bright chrome

LINOLEUM



Pebble
4175
NCS 3502-Y

Ash
4132
NCS 5502-G

Black
4023
NCS 9000-N

LAMINATE



Grey
U1115 W
Duropal
NCS S4502-G

White
F7949 Soft
white Formica
RAL 9016

Graphite
F7837 Graphite
Formica
RAL8019

Wood pattern oak
F 5374 Elegant oak
Formica

RECOMMENDED FABRIC, LEATHER & ARTIFICIAL LEATHER

| GROUP A | GROUP B | GROUP C | LEATHER 1 | LEATHER 2 |
|---------------------|-------------------------------|---------------------------------|-----------|-----------|
| Cura, Mainline Plus | Fame, Haku, Illusion, Remix 3 | Hallingsdal 65, Steelcut Trio 3 | Hero | Savanne |

See the overview of fabric, leather and artificial leather on page 89

CERTIFICATIONS



EU Ecolabel certification on specific products:

- Pause with wood shell (866134)
- Pause with seat and back upholstery (8661)
- Pause Runner with seat and back in veneer (8640)
- Pause Runner with seat and back upholstery (8640)

EU Ecolabel: DK/049/016

23% rabatt ska dras av på angivna priser

PAUSE

DESIGN: (2005) BUSK + HERTZOG

SPECIFICATIONS & MEASUREMENTS

| | |
|----------------------|---|
| Description | Simple and light chair that can be easily stacked or lined up in rows. |
| Measurement | W53 x D53 x H80 x SH45 cm |
| Weight | Without upholstery: Gross/Net: 5,7/4,6 kg/pc. 5 pcs/cart. 0,395 cbm/cart With upholstery: Gross/Net: 5,7/4,6 kg/pc. 4 pcs/cart. 0,395 cbm/cart |
| Seat and back | Laminated plywood with laminate or linoleum, composite or oak veneer and fully or partially upholstered |
| Frame | Tubular steel |
| Stackable | Without upholstery: Floor: 10 pcs. Trolley 20 pcs. With upholstery: Floor: 8 pcs. Trolley 12 pcs. |



PAUSE

| Item No. | Product | Without upholstery | A | B | C | 1 | 2 |
|----------|--|--------------------|-------|-------|-------|-------|-------|
| MO 8661 | Seat and back in plywood with laminate or linoleum | 3.825 | | | | | |
| MO 8661 | Seat and back in plywood with oak veneer | 4.160 | | | | | |
| MO 8661 | Seat and back in black composite | 3.325 | | | | | |
| MO 8661 | Seat and back in beige or brown-grey composite | 4.070 | | | | | |
| MO 8661 | Back in laminate/linoleum/composite and seat upholstered | | 4.660 | 4.970 | 5.400 | 5.675 | 6.410 |
| MO 8661 | Seat and back fully upholstered | | 4.970 | 5.785 | 6.800 | 7.450 | 8.495 |

ADDITIONAL PURCHASE

| Item No. | Product | Price |
|----------|--|-------|
| | Seat and back in black-stained oak | 835 |
| | Black screws in the back when the frame is black | 250 |

ACCESSORIES

| Item No. | Product | Price |
|-----------|--|--------|
| MO 1387 | Single hang-up bracket - two rods in bright chromed steel. Mini. Table length: 2 stole 140 cm/3 stole 200 cm. Min. table length: Mix table 80 cm, Brunch table 90 cm | 795 |
| MO 1201 | Linking device - 1 set in black plastic - distance between the legs of the chairs: 1 cm | 510 |
| MO 1186 | Trolley, painted black | 14.700 |
| MO 1501 | Writing tablet, removable, white compact laminate with black core. Tubular steel in bright chrome | 2.995 |
| MO 1600 | 4 pcs loose hard glides, black, for soft floors | 160 |
| MO 1601 | 4 pcs. loose, less hard plastic glides, dark grey (for hard floors) | 160 |
| MO 1602 | 4 pcs. felt glides | 185 |
| MO 1834-1 | 1 set composite seat and back, black + screws | 2.075 |
| MO 1834-2 | 1 set composite seat and back, beige/brown-grey + screws | 2.820 |

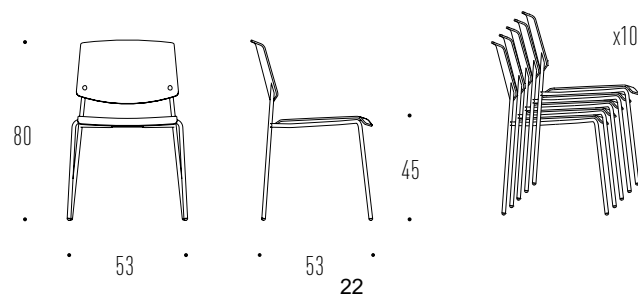

23% rabatt ska dras av på angivna priser

PAUSE RUNNER

DESIGN: (2016) BUSK + HERTZOG

SPECIFICATIONS & MEASUREMENTS

| | |
|----------------------|--|
| Description | Pause Runner is particularly suitable for row settings, stacking and storage on a trolley. |
| Measurement | W52 x D54 x H81 x SH45 cm |
| Weight | Gross/Net: 6.5/6 kg/pc. 4 pcs/cart. 0.395 cbm/cart |
| Seat and back | Laminated plywood with laminate or linoleum, composite or oak veneer and fully or partially upholstered |
| Frame | Tubular steel |
| Stackable | Without upholstery: Floor: 20 pcs. Trolley: 40 pcs. With upholstery: Floor: 10-12 pcs. Trolley: 20 pcs. |

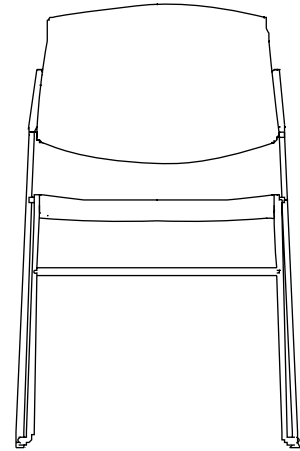

PAUSE RUNNER

| Item No. | Product | Without upholstery | A | B | C | 1 | 2 |
|----------|--|--------------------|-------|-------|-------|-------|-------|
| MO 8640 | Seat and back in plywood with laminate or linoleum | 4.325 | | | | | |
| MO 8640 | Seat and back in plywood with oak veneer | 5.275 | | | | | |
| MO 8640 | Back in laminate/linoleum/composite and seat upholstered | | 4.995 | 5.435 | 5.870 | 6.145 | 6.600 |
| MO 8640 | Seat and back fully upholstered | | 5.210 | 5.995 | 6.960 | 7.585 | 8.575 |

ADDITIONAL PURCHASE

| Item No. | Product | Price |
|----------|---|-------|
| | Seat and back in black-stained oak | 835 |
| | Built-in linking device (Minimum purchase 100 pcs.) | 600 |

ACCESSORIES

| Item No. | Product | Price |
|----------|---|--------|
| MO 1606 | 4 pcs loose, plastic glides, transparent | 135 |
| MO 1607 | 4 pcs loose, felt glides, transparent | 335 |
| MO 1503 | Writing tablet, detachable - white laminate | 2.995 |
| MO 1156 | Trolley, painted black, for up to 40 chairs | 12.720 |

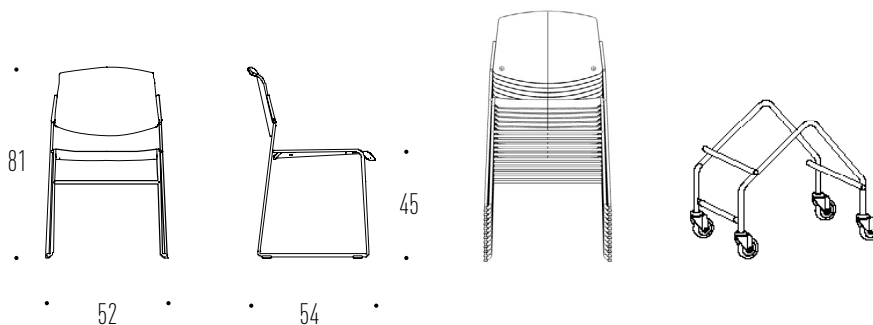

23% rabatt ska dras av på angivna priser

PAUSE BAR STOOL

DESIGN: (2006) BUSK + HERTZOG

SPECIFICATIONS & MEASUREMENTS

| | |
|--------------------|---|
| Description | Light bar chair with curved seat that makes it possible to sit up from all sides. Available in two heights, Bar and Counter height. |
| Measurement | MO 8664: W41 x D35 x H81 x SH81 cm MO 8663: W41 x D35 x H65 x SH65 cm |
| Weight | Gross/Net: 5,9/4,5 kg/pc. 2 pcs/cart. 0,339 kbm/kart |
| Seat | Laminated plywood with laminate/linoleum, oak veneer or upholstery |
| Frame | Tubular steel |

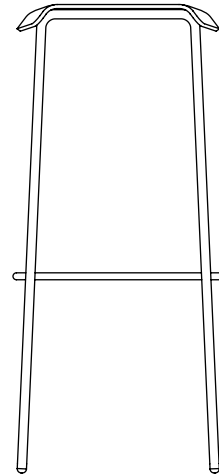

PAUSE BAR STOOL

| Item No. | Product | Without upholstery | A | B | C | 1 | 2 |
|------------------|------------------------------------|--------------------|-------|-------|-------|-------|-------|
| MO 8664, MO 8663 | Seat in oak with laminate/linoleum | 4.500 | | | | | |
| MO 8664, MO 8663 | Seat in oak | 4.735 | | | | | |
| MO 8664, MO 8663 | Seat upholstery | | 4.975 | 5.775 | 6.295 | 6.625 | 7.150 |

ADDITIONAL PURCHASE

| Item No. | Product | Price |
|----------|---------------------------|-------|
| | Seat in black-stained oak | 835 |

ACCESSORIES

| Item No. | Product | Price |
|----------|---|-------|
| MO 1600 | 4 pcs. hard plastic glides, black (for soft floors) | 75 |
| MO 1601 | 4 pcs. less hard plastic glides, grey (for soft floors) | 75 |
| MO 1602 | 4 pcs. felt glides | 185 |

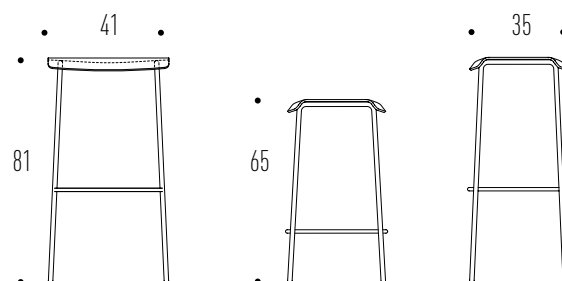

23% rabatt ska dras av på angivna priser

SESSION SERIES

DESIGN: (2003) BUSK + HERTZOG

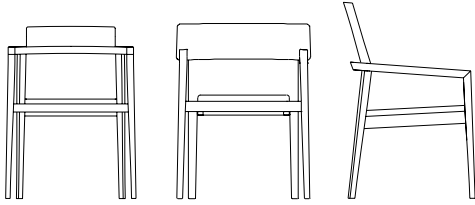

Japanese and Scandinavian aesthetics meet classic shaker traditions in the stackable armchairs in the Session Series. A simple design with a strong sense of form, meeting all demands with regards to comfort, strength and applicability.

WOOD & TREATMENTS

See product details on the individual product pages



Oak,
transparent
lacquer

Oak, natural
oil

Oak,
white-oil

Oak, soap
treatment

Oak, black-
stained

RECOMMENDED FABRIC, LEATHER & ARTIFICIAL LEATHER

| GROUP A | GROUP B | GROUP C | LEATHER 1 | LEATHER 2 |
|----------------------|--------------------------------|----------------------------------|-----------|---|
| Cura, Main Line Plus | Frame, Remix 3, Illusion, Haku | Hallingdal 65 og Steelcut Trio 3 | Hero | Savanne, Triumph Crib (Triumph Crib suitable for use within the Care sector) |

See the overview of fabric, leather and artificial leather on page 89

23% rabatt ska dras av på angivna priser

SESSION PURE

DESIGN: (2022) BUSK + HERTZOG

SPECIFICATIONS & MEASUREMENTS

| | |
|----------------------|--|
| Description | The curved wooden back gives the chair a distinctive look and a high degree of comfort at the same time. |
| Measurement | W58 x D54 x H77 x SH45 cm |
| Weight | Gross/Net: 7/6 kg/pc. 6 pcs/cart. 0,550 cbm/cart |
| Seat and back | Laminated plywood back with oak veneer, seat fully upholstered |
| Frame | Solid oak |
| Stackable | Floor: 10 pcs. Trolley: 10 pcs. |



SESSION PURE

| Item No. | Product | A | B | C | 1 | 2 |
|----------|----------------------------------|-------|-------|-------|-------|-------|
| MO 9401 | Back in oak and seat upholstered | 7.085 | 7.825 | 8.250 | 8.750 | 9.250 |

ADDITIONAL PURCHASE

| Item No. | Product | Price |
|----------|-------------------------------------|-------|
| | Back and frame in black-stained oak | 835 |

ACCESSORIES

| Item No. | Product | Price |
|----------|----------------------------------|--------|
| MO 1637 | 2 built-in castors in front legs | 2.000 |
| MO 1694 | Floor mounting brackets | 510 |
| MO 1194 | Trolley for 10 chairs | 11.560 |
| MO 1616 | 4 pcs. plastic glides, white | 135 |
| MO 1617 | 4 pcs. felt glides, white | 135 |

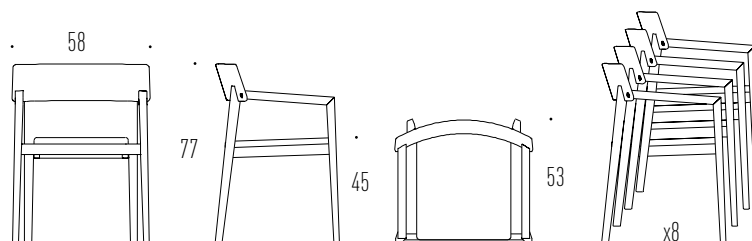

23% rabatt ska dras av på angivna priser

SESSION

DESIGN: (2003) BUSK + HERTZOG

SPECIFICATIONS & MEASUREMENTS

| | |
|----------------------|---|
| Description | Japanese and Scandinavian aesthetics meet shaker traditions in this stackable armchair. |
| Measurement | W58 x D52 x H77 x SH45 cm |
| Weight | Gross/Net: 7/6 kg/pc. 6 pcs/cart. 0,550 cbm/cart |
| Seat and back | Fully upholstered back and seat. Seat cushion is detachable and can be revolved 180° |
| Frame | Solid oak |
| Stackable | Floor: 10 pcs. Trolley: 10 pcs. |



SESSION

| Item No. | Product | A | B | C | 1 | 2 |
|----------|---------------------------|--------|--------|--------|--------|--------|
| MO 9401 | Seat and back upholstered | 12.095 | 12.720 | 13.445 | 13.925 | 14.685 |

ADDITIONAL PURCHASE

| Item No. | Product | Price |
|----------|--|-------|
| | Frame in black-stained oak | 835 |
| MO 1826 | Removable seat cover and urinary cover over foam | 1.035 |

ACCESSORIES

| Item No. | Product | Price |
|----------|---|--------|
| MO 1203 | Linking device, removable, in stainless steel | 675 |
| MO 1637 | 2 built-in castors in front legs | 2.000 |
| MO 1694 | Floor mounting brackets | 510 |
| MO 1194 | Trolley for 10 chairs | 11.560 |
| MO 1616 | 4 pcs. plastic glides, white | 135 |
| MO 1617 | 4 pcs. felt glides, white | 135 |

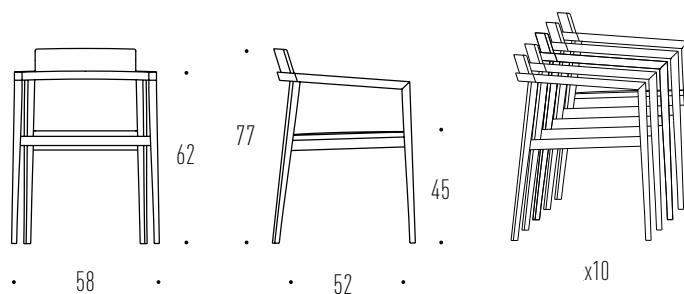

23% rabatt ska dras av på angivna priser

SESSION RELAX

DESIGN: (2003) BUSK + HERTZOG

SPECIFICATIONS & MEASUREMENTS

| | |
|----------------------|---|
| Description | Minimalistic design with great seating comfort, which makes it suitable as a conference/resting chair. |
| Measurement | W63 x D60 x H92 x SH45 cm |
| Weight | Gross/Net: 11.6/10 kg/pc. 3 pcs/cart. 0.550 cbm/cart |
| Back height | 44 cm |
| Seat and back | Fully upholstered, removable back and seat cushion. Seat cushion is detachable and can be revolved 180° |
| Frame | Solid oak |
| Stackable | Floor: 6 pcs. Trolley: 6 pcs. |

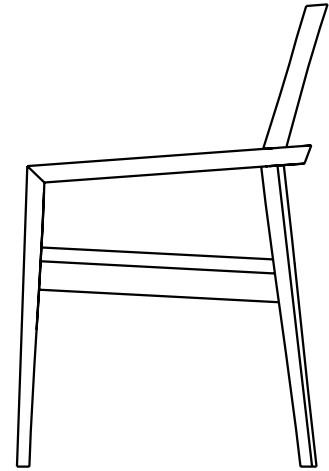

SESSION RELAX

| Item No. | Product | A | B | C | 1 | 2 |
|----------|---------------------------|--------|--------|--------|--------|--------|
| MO 9406 | Seat and back upholstered | 13.775 | 15.125 | 16.800 | 17.810 | 19.520 |

ADDITIONAL PURCHASE

| Item No. | Product | Price |
|----------|--|-------|
| | Frame in black-stained oak | 835 |
| MO 1827 | Removable seat cover and urinary cover over foam | 1.035 |

ACCESSORIES

| Item No. | Product | Price |
|----------|---|--------|
| MO 1203 | Linking device, removable, in stainless steel | 675 |
| MO 1637 | 2 built-in castors in front legs | 2.000 |
| MO 1694 | Floor mounting brackets | 510 |
| MO 1194 | Trolley for 6 chairs | 11.560 |
| MO 1616 | 4 pcs. plastic glides, white | 135 |
| MO 1617 | 4 pcs. felt glides, white | 135 |

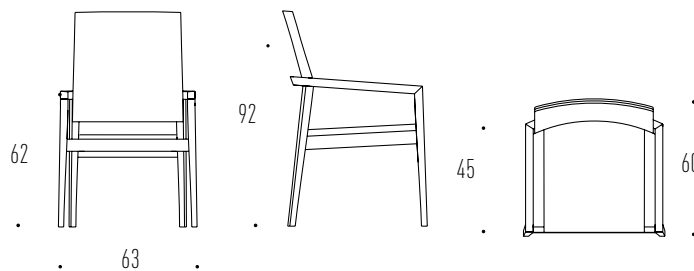

23% rabatt ska dras av på angivna priser

TONICA WOOD

DESIGN: (2013) NIELS GAMMELGAARD

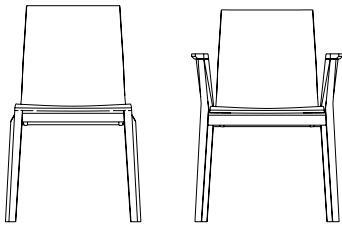

A modern idea of a simple wooden chair with a strong sense of form. Tonica Wood has a good lumbar support and flexibility in the back, ensuring a very high seating comfort. The chair is available in all wood and fully or partially upholstered, with or without armrests, and can be stacked.

WOOD & TREATMENTS



Oak,
transparent
lacquer



Oak, black-stained

RECOMMENDED FABRIC, LEATHER & ARTIFICIAL LEATHER

| GROUP A | GROUP B | GROUP C | LEATHER 1 | LEATHER 2 |
|----------------------|----------------------------------|-----------------------------------|--------------|-----------------|
| Cura, Main Line Plus | Fame, Remix 3, Illusion, Haku | Hallingdal 65, Steelcut Trio 3 | Hero, Sydney | Savanne, Vacona |

See the overview of fabric, leather and artificial leather on page 89

23% rabatt ska dras av på angivna priser

TONICA WOOD

DESIGN: (2013) NIELS GAMMELGAARD

SPECIFICATIONS & MEASUREMENTS

| | |
|----------------------|---|
| Description | Strong wooden chair with great lumbar support and flexibility in the back. |
| Measurement | W52 x D55 x H80 x SH45 cm |
| Weight | Gross/Net: 6,5/6 kg/pc. 3 pcs/cart. 0,41 cbm/cart |
| Seat and back | Laminated plywood with veneer in oak |
| Frame | Solid oak |
| Stackable | Without upholstery: Floor: 9 pcs. Trolley 9 pcs. With upholstery: Floor: 6 pcs. Trolley 6 pcs. |

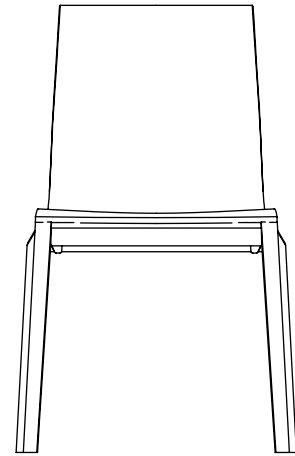

TONICA WOOD

| Item No. | Product | Without upholstery | A | B | C | 1 | 2 |
|----------|------------------------|--------------------|-------|--------|--------|--------|--------|
| MO 5330 | Chair in oak | 7.570 | | | | | |
| MO 5330 | Fully upholstered | | 8.970 | 10.670 | 12.760 | 14.070 | 16.195 |
| MO 5330 | Front side upholstered | | 9.420 | 11.200 | 13.400 | 14.770 | 17.000 |

ADDITIONAL PURCHASE

| Item No. | Product | Price |
|----------|--------------------------------------|-------|
| | Frame and shell in black-stained oak | 835 |

ACCESSORIES

| Item No. | Product | Price |
|----------|--|--------|
| MO 1204 | Linking device, detachable (incl. of brackets on each chair) | 835 |
| MO 1211 | Linking device/hymn book holder | 1.100 |
| MO 1616 | 4 pcs plastic glides, white | 185 |
| MO 1617 | 4 pcs felt glides, white | 185 |
| MO 1637 | 2 built-in castors in front legs | 2.000 |
| MO 1194 | Trolley for 6-9 chairs | 11.560 |

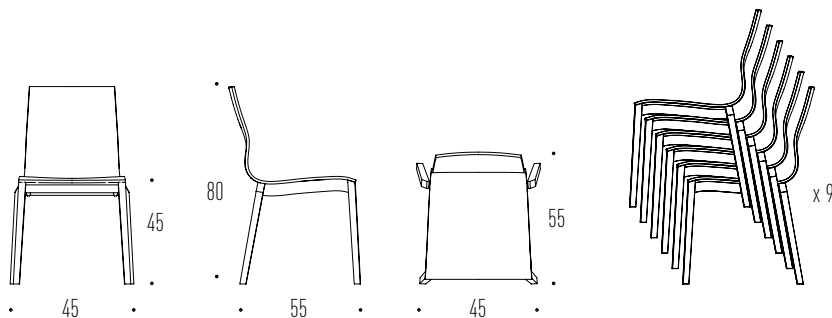

23% rabatt ska dras av på angivna priser

TONICA WOOD WITH ARMREST

DESIGN: (2013) NIELS GAMMELGAARD

SPECIFICATIONS & MEASUREMENTS

| | |
|--------------------------|---|
| Description | Strong wooden chair with armrest and great lumbar support and flexibility in the back. |
| Measurement | B59 x D55 x H80 x SH45 cm |
| Weight | Gross/Net: 8/7,5 kg/pc. 3 pcs/cart. 0,41 cbm/cart |
| Seat and back | Laminated plywood with veneer in oak |
| Frame and armrest | Solid oak |
| Stackable | Without upholstery: Floor: 9 pcs. Trolley 9 pcs. With upholstery: Floor: 6 pcs. Trolley 6 pcs. |

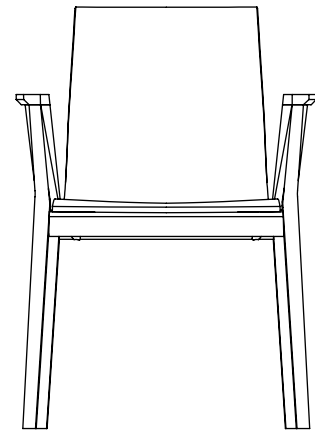

TONICA WOOD WITH ARMREST

| Item No. | Product | Without upholstery | A | B | C | 1 | 2 |
|----------|------------------------|--------------------|--------|--------|--------|--------|--------|
| MO 5331 | Chair in oak | 8.750 | | | | | |
| MO 5331 | Fully upholstered | | 10.160 | 11.850 | 13.935 | 15.260 | 17.385 |
| MO 5331 | Front side upholstered | | 10.670 | 12.445 | 14.635 | 16.025 | 18.250 |

ADDITIONAL PURCHASE

| Item No. | Product | Price |
|----------|--------------------------------------|-------|
| | Frame and shell in black-stained oak | 835 |

ACCESSORIES

| Item No. | Product | Price |
|----------|--|--------|
| MO 1205 | Linking device, detachable (incl. of brackets on each chair) | 835 |
| MO 1212 | Linking device/hymn book holder | 1.195 |
| MO 1616 | 4 pcs plastic glides, white | 185 |
| MO 1617 | 4 pcs felt glides, white | 185 |
| MO 1637 | 2 built-in castors in front legs | 2.000 |
| MO 1194 | Trolley for 6-9 chairs | 11.560 |

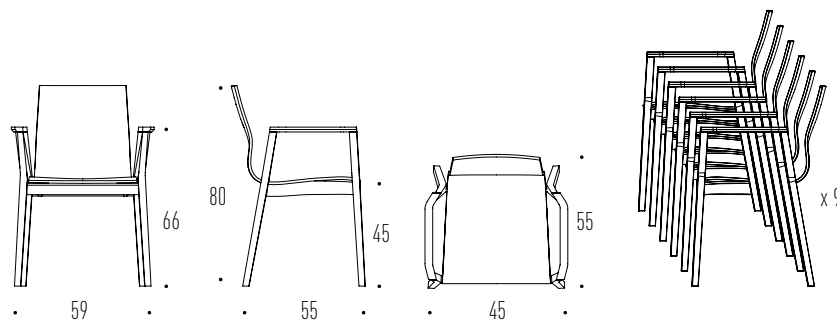

23% rabatt ska dras av på angivna priser

ADDI MEETING

DESIGN: (2013) FRIIS & MOLTKE DESIGN

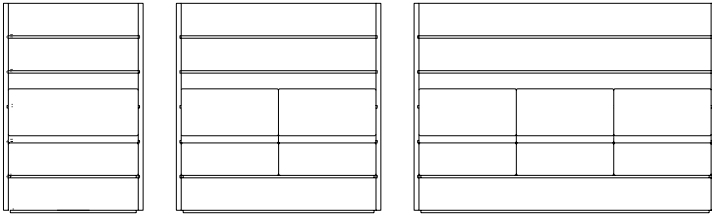

The purpose of Addi Meeting is as a flexible furniture element, ideal where people meet in various connections. Furniture element with high screening walls on the sides and the back, offering a more private *room in the room*. Addi Meeting is available as 1-, 2- and 3-seater modules. Seat and back cushions are detachable and thus easy to exchange and combinations of colours within each element become possible.

WOOD & TREATMENTS



Oak, transparent
lacquer

BASE COLOURS



Black painted

RECOMMENDED FABRIC, LEATHER & ARTIFICIAL LEATHER

| GROUP A | GROUP B | GROUP C | LEATHER 1 | LEATHER 2 |
|--------------|-------------------------|-----------------------------------|-----------|-----------|
| Cura, Medley | Fame, Remix 3, Illusion | Hallingdal 65, Steelcut Trio 3 | Hero | Savanne |

See the overview of fabric, leather and artificial leather on page 89

23% rabatt ska dras av på angivna priser

ADDI MEETING

DESIGN: (2013) FRIIS & MOLTKE

SPECIFICATIONS & MEASUREMENTS

- Description** A flexible furniture element with high screening walls on the sides and back, offering a more private lounge area - especially suitable for open office environments
- Measurement** 3 size variants (1,2,3 seaters)
- Seat and back** Fully upholstered seat and back, both are detachable with side wall and back wall
- Frame** Painted black

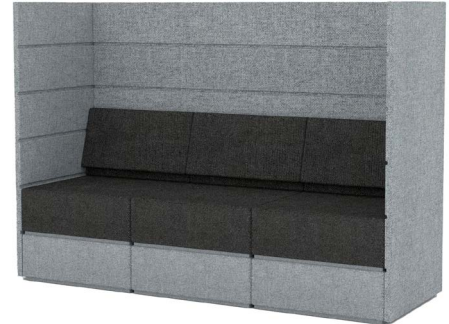

ADDI MEETING 1-SEATER

| Item No. | Product | Size | A | B | C | 1 | 2 |
|----------|-------------|-------------------------|--------|--------|--------|--------|--------|
| MO 5354 | Upholstered | W86 x D63 x H130 X SH45 | 34.845 | 44.250 | 46.600 | 62.520 | 73.885 |

ADDI MEETING 2-SEATER

| Item No. | Product | Size | A | B | C | 1 | 2 |
|----------|-------------|--------------------------|--------|--------|--------|--------|---------|
| MO 5356 | Upholstered | W126 x D63 x H130 X SH45 | 51.395 | 64.110 | 67.275 | 88.760 | 104.125 |

ADDI MEETING 3-SEATER

| Item No. | Product | Size | A | B | C | 1 | 2 |
|----------|-------------|--------------------------|--------|--------|--------|---------|---------|
| MO 5357 | Upholstered | W186 x D63 x H130 X SH45 | 75.310 | 92.835 | 97.195 | 126.785 | 147.935 |

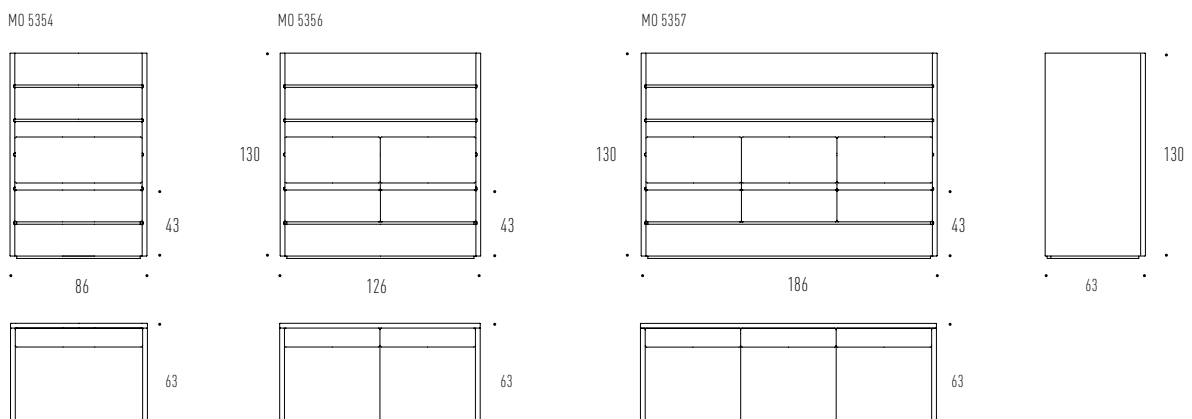

23% rabatt ska dras av på angivna priser

BRUNCH TABLE SERIES

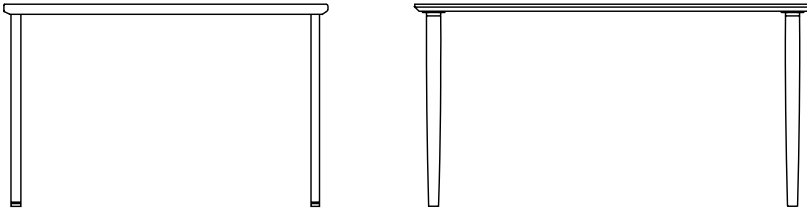

Brunch is a distinctive table with a simple, sleek and clear-cut expression. The 2,2mm slim table top of plywood is robust, and especially with a surface of high-pressure laminate, extremely durable and particularly suitable for canteens, cafés and waiting areas. Brunch is available with steel or wooden legs as a regular standard table, or with foldable legs.

WOOD & TREATMENTS

See product details on the individual product pages

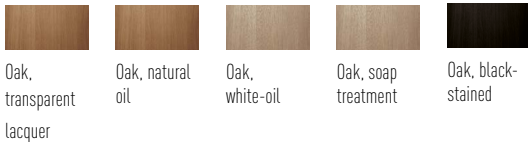

LINOLEUM

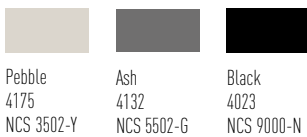

LAMINATE

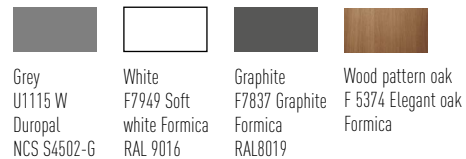

STEEL COLOURS

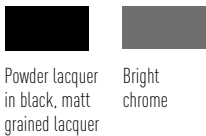

TABLE LEGS



STANDARD STEEL LEGS
MO 6671



STANDARD CONICAL WOODEN
LEGS MO 6676



STEEL FOLDING LEGS
MO 6665 - STRAIGHT
MO 6667 - SLANTED

WOODEN FOLDING LEGS
MO 6666 - STRAIGHT
MO 6668 - SLANTED

23% rabatt ska dras av på angivna priser

BRUNCH TABLE SERIES

DIMENSIONER

| | 70 cm | 80 cm | 90 cm | |
|--------|-------|-------|-------|--|
| 80 cm | | | | |
| 90 cm | | | | |
| 120 cm | | | | |
| 140 cm | | | | |
| 180 cm | | | | |
| 200 cm | | | | |
| 210 cm | | | | |

FOLDING FUNCTION

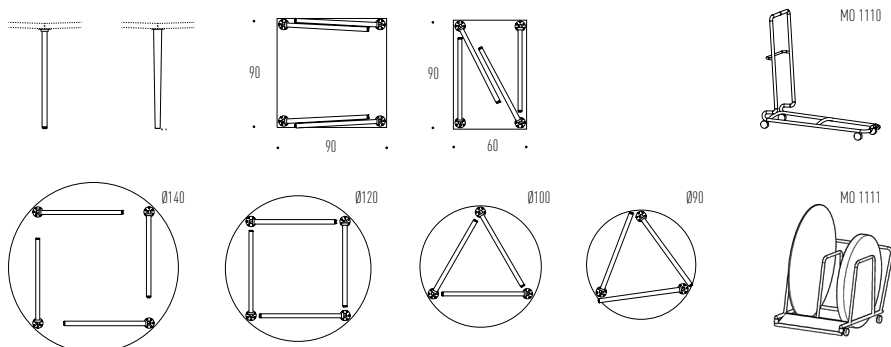

23% rabatt ska dras av på angivna priser

BRUNCH WITH STEEL LEGS

SPECIFICATIONS & MEASUREMENTS

| | |
|---------------------|---|
| Description | Extremely durable table series with/without folding function. |
| Table height | 74 cm |
| Table top | 25 mm slim table top in plywood with chamfered plywood edge, lacquered or black stained, or straight ABS-edge |
| Table legs | Steel legs are mounted in a 90 degree angle on table top. Standard with adjustable glide |
| Folding legs | Straight (MO 6665) or slanted with a 5 degree slant outwards (MO 6667) |
| Stacking | Trolleys for folding tables - 10 rectangular or 7 round |



BRUNCH WITH STEEL LEGS

| Item No. | Size | Table with steel legs | Table with steel folding legs |
|----------------------|-------------|-----------------------|--------------------------------------|
| | | MO 6671 | MO 6665 (straight)/MO 6667 (slanted) |
| MO 6671/6665/6667-0 | 70 x 120 cm | 8.465 | 13.020 |
| MO 6671/6665/6667-1 | 70 x 140 cm | 9.305 | 13.860 |
| MO 6671/6665/6667-2 | 80 x 80 cm | 7.670 | |
| MO 6671/6665/6667-3 | 80 x 120 cm | 9.220 | 13.775 |
| MO 6671/6665/6667-4 | 80 x 140 cm | 10.005 | 14.560 |
| MO 6671/6665/6667-5 | 80 x 160 cm | 11.570 | |
| MO 6671/6665/6667-6 | 80 x 180 cm | 11.690 | 16.245 |
| MO 6671/6665/6667-7 | 80 x 200 cm | 12.530 | 17.085 |
| MO 6671/6665/6667-11 | 90 x 90 cm | 8.765 | 13.320 |
| MO 6671/6665/6667-12 | 90 x 140 cm | 10.765 | 15.320 |
| MO 6671/6665/6667-13 | 90 x 200 cm | 13.630 | 18.185 |
| MO 6671/6665/6667-14 | 90 x 210 cm | 14.205 | 18.760 |
| MO 6671/6665/6667-9 | Ø120 cm | 11.205 | 15.760 |

ADDITIONAL PURCHASE

| Item No. | Product | Price |
|----------|-----------------------------------|-------|
| | Black-stained table top in veneer | 1.585 |

ACCESSORIES

| Item No. | Product | Price |
|----------|--|--------|
| MO 1110 | Trolley, painted black, for rectangular tables with folding legs - for approx. 10 tables. W60xL150xH136 cm | 24.000 |
| MO 1111 | Trolley, painted black, for circular tables. W85xD134XK101 cm. Internal width: 77 cm | 21.375 |

23% rabatt ska dras av på angivna priser

BRUNCH WITH CONICAL WOODEN LEGS

SPECIFICATIONS & MEASUREMENTS

| | |
|---------------------|---|
| Description | Extremely durable table series with/without folding function. |
| Table height | 74 cm |
| Table top | 25 mm slim table top in plywood with chamfered plywood edge, lacquered or black stained, or straight ABS-edge |
| Table legs | Conical wooden legs are mounted in a 90 degree angle on the table top |
| Folding legs | Straight (MO 6666) or slanted with a 5 degree slant outwards (MO 6668) |
| Stacking | Trolleys for folding tables - 10 rectangular or 7 round |



BRUNCH WITH CONICAL WOODEN LEGS

| Item No. | Size | Tabel with conical wooden legs | |
|------------|-------------|--------------------------------|--------------------------------------|
| | | MO 6676 | MO 6666 (straight)/MO 6668 (slanted) |
| MO 6676-0 | 70 x 120 cm | 10.330 | 14.815 |
| MO 6676-1 | 70 x 140 cm | 11.170 | 15.655 |
| MO 6676-2 | 80 x 80 cm | 9.535 | |
| MO 6676-3 | 80 x 120 cm | 11.085 | 15.570 |
| MO 6676-4 | 80 x 140 cm | 11.870 | 16.355 |
| MO 6676-5 | 80 x 160 cm | 13.435 | |
| MO 6676-6 | 80 x 180 cm | 13.555 | 18.040 |
| MO 6676-7 | 80 x 200 cm | 14.395 | 18.880 |
| MO 6676-10 | 80 x 210 cm | 14.935 | 19.420 |
| MO 6676-11 | 90 x 90 cm | 10.630 | 15.115 |
| MO 6676-12 | 90 x 140 cm | 12.630 | 17.115 |
| MO 6676-13 | 90 x 200 cm | 15.495 | 19.980 |
| MO 6676-14 | 90 x 210 cm | 16.070 | 20.555 |
| MO 6676-8 | Ø90 cm | 9.235 | 13.720 |
| MO 6676-9 | Ø120 cm | 13.070 | 17.555 |

ADDITIONAL PURCHASE

| Item No. | Product | Price |
|----------|---|-------|
| | Table top and legs in black-stained oak | 1.585 |
| MO 6673 | Hidden castors, not swiveling per castor - only for rectangular and square tables | 325 |

ACCESSORIES

| Item No. | Product | Price |
|----------|--|--------|
| MO 1110 | Trolley, painted black, for rectangular tables with folding legs - for approx. 10 tables. W60xL150xH136 cm | 24.000 |
| MO 1111 | Trolley, painted black, for circular tables. W85xD134XK101 cm. Internal width: 77 cm | 21.375 |

23% rabatt ska dras av på angivna priser

TRIO



A small cluster of coffee tables, circular, square and rectangular in solid oak or in plywood with all our standard laminate and linoleum colours. The tables are available in six sizes and three heights, making a vast number of combinations possible. Conical legs in solid oak, lacquered or black stained.

WOOD & TREATMENTS



Oak, transparent lacquer
Oak, natural oil
Oak, white-oil
Oak, soap treatment
Oak, black-stained

LINOLEUM



Pebble 4175 NCS 3502-Y
Ash 4132 NCS 5502-G
Black 4023 NCS 9000-N

LAMINATE



Grey U1115 W Duopal NCS S4502-G
White F7949 Soft white Formica RAL 9016
Graphite F7837 Graphite Formica RAL8019
Wood pattern oak F 5374 Elegant oak Formica

23% rabatt ska dras av på angivna priser

TRIO

SPECIFICATIONS & MEASUREMENTS

Description Trio lounge and coffee tables in a multitude of combination.
Table top thickness 25 mm
Table top Solid oak with beveled edge, or plywood with linoleum/laminate surface, beveled plywood edge
Table legs Solid oak

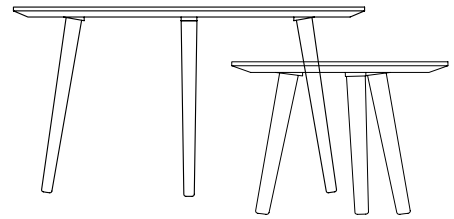

TRIO

| Item No. | Size | Price for table top with laminate |
|-----------|-----------------------------------|-----------------------------------|
| MO 9580-1 | Ø40 cm (Height: 40/45 cm) | 3.060 |
| MO 9580-2 | Ø60 cm (Height: 40/45/50 cm) | 4.445 |
| MO 9580-3 | Ø85 cm (Height: 40/45/50 cm) | 6.860 |
| MO 9580-4 | 110 x 60 cm (Height: 40/45/50 cm) | 6.445 |
| MO 9580-5 | 60 x 60 cm (Height: 40/45/50 cm) | 5.095 |
| MO 9580-6 | 125 x 70 cm (Height: 40/45/50 cm) | 8.620 |

ADDITIONAL PURCHASE

| Product | Price |
|---|-------|
| Table top with linoleum | 835 |
| Table top with in oak | 1.670 |
| Legs and table top/table top surface in black-stained oak | 1.585 |
| 1 additional leg on Trio tables Ø 60 and Ø 85 cm to have 4 legs | 1.995 |

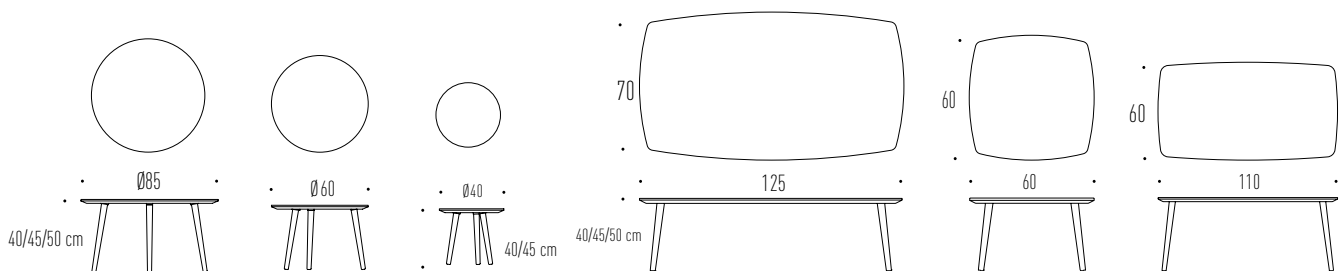

23% rabatt ska dras av på angivna priser

MEETING TABLE

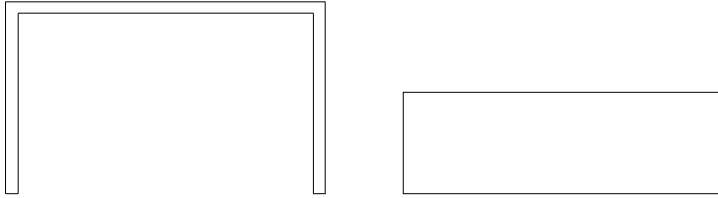

An elegant gable table in a light-weight material - the core of the table top consists of Honeycomb which minimizing material consumption and, at the same time, makes the table light and very strong. Two built-in castors are mounted in one of the gables, so the table can be easily moved to the area where it is to be used. A bar table for many different rooms and particularly useful as a meeting bar table, with the option of both hang-up function for bar chairs and foot rest.

WOOD & TREATMENTS



Oak,
transparent
lacquer



Oak, black-
stained

LINOLEUM



Pebble
4175
NCS 3502-Y



Ash
4132
NCS 5502-G



Black
4023
NCS 9000-N

LAMINATE



Grey
U1115 W
Duropal
NCS S4502-G



White
F7949 Soft
white
Formica
RAL 9016



Graphite
F7837 Graphite
Formica
RAL8019



Wood pattern oak
F 5374 Elegant oak
Formica

23% rabatt ska dras av på angivna priser

MEETING TABLE

SPECIFICATIONS & MEASUREMENTS

| | |
|----------------------------|--|
| Description | An elegant gable table in a light-weight material. |
| Table top thickness | Table top and gable: 55 mm |
| Table top and gable | Surface in laminate, linoleum or oak |
| Details | Two built-in castors are mounted in one of the gables |
| Sizes | W50-100 x L100-500 x H50-110 cm. For lengths over 250 cm, the table is divided into two and assembled in the middle + has a visible steel rail under the table top. Contact the factory for price information for the desired size(s) and executions |

MEETING TABLE

| Item No. | Sizes | Product | Price |
|-----------|-------------|-------------------|--------|
| MO 8691-1 | 160x60xH110 | Laminate/Linoleum | 28.970 |
| MO 8691-1 | 160x60xH110 | Veneer | 31.145 |
| MO 8691-2 | 200x60xH110 | Laminate/Linoleum | 33.245 |
| MO 8691-2 | 200x60xH110 | Veneer | 35.735 |

ADDITIONAL PURCHASE

| Item No. | Product | Price |
|----------|-------------------|-------|
| | Black-stained oak | 2.500 |

ACCESSORIES

| Item No. | Product | Price |
|----------|---|-------|
| | Hang-up pole for Pause bar chair - 160 cm | 1.085 |
| | Hang-up pole for Pause bar chair - 200 cm | 1.420 |
| | Foot rest - 160 cm | 2.325 |
| | Foot rest - 200 cm | 2.585 |

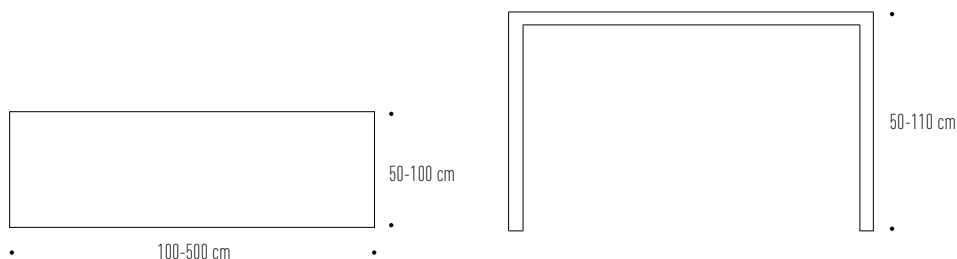

23% rabatt ska dras av på angivna priser

FABRIC, LEATHER & ARTIFICIAL LEATHER

Click on the individual fabric/leather/artificial leather for colours, specifications etc.

| PRICE RANGES | ARTIFICIAL LEATHER | WOOL | POLYESTER | TREVIRA CS/FR | GENUINE LEATHER |
|--------------|--------------------------------------|--|--|--|--|
| A | | Connect (2) Main Line Plus (3) | Cura (2) Era (3) Medley (2) Quest (3) | | |
| B | Illusion (7) PVC-fri | Atlas (1) Blazer (3) Crisp (2) Fame (2) Focus + Focus Melange (2) Main Line Flax (3) Morph (2) Select (2) Sumi (3) Synergy (3) Remix 3 (1) | Reflect (1) | Go Uni (2) Go Check (2) Go Couture (2) Step (2) Step Melange (2) Relate (1) | |
| C | | Hallingdal 65 (1) Steelcut Trio 3 (1) | | | |
| 1 | | | | | Sydney (6) Semi aniline Hero (4) Surface treated |
| 2 | | | | | Savanne (4) Semi aniline Triumph Crib (4) Surface treated Vacona (6) Aniline |

Green letters indicate that the fabric or artificial leather is tested according to one or more of the following: Oeko-Tex®, EU- Ecolabel, Greenguard Certification, Indoor Advantage Gold Certificate. For leather green letters, indicate that the leather is tanned without chrome. Blue letters indicate that the leather is suitable for use in the Care sector.

Suppliers

(1) Kvadrat / (2) Gabriel / (3) Camira / (4) Sørensen Leather / (5) CA-MO Leather/ (6) Nevotex

23% rabatt ska dras av på angivna priser

FABRICS, ARTIFICIAL LEATHER AND LEATHER

Price ranges

The fabrics, as well as the fire-retardant CMHR polyurethane foam with high density: 60 kg/m³, have been chosen in due consideration of the fact that they should be able to withstand many years of hard daily wear regarding abrasion resistance, elasticity and cleaning

1. Abrasion resistance

According to the Technical Specifications from Danish Furnituremakers' Quality Control furniture fabrics used on a firm upholstery, which is on all our seating furniture, should fulfill the requirements of an abrasion resistance of 45.000 rubs according to the Martindale test method when exposed to normal use and 75.000 rubs in cases where the furniture is exposed to severe use as for instance in public environments. For less severe use a minimum of 25.000 rubs is needed.

2. Elasticity

On account of the from upholstery the fibres in the furniture fabric must have a certain degree of elasticity, i.e. the ability to contract after having been used, in order to avoid wrinkles or puckers which may occur when using cotton fabrics lacking this elasticity. In time leather stretches and wrinkles - more on a thick upholstery than on a thinner back upholstery. The thick leather types stretch less than thin leather.

3. Cleaning

As the major part of our seating furniture has a fixed upholstery, it is important that the furniture fabric is dirt-repellent and stands cleaning throughout a long period of time. This applies to woollen fabrics whereas Trevira CS and cotton fabrics attract dirt. This is why a removable seat cover should be chosen for seating furniture with a Trevira CS fabric in order to make the seat cover washable. Leather must have a surface treatment.

We reserve the right to reject furniture fabrics, vinyls or leather that we find unsuitable for the purpose of the furniture

Steel surfaces

Bright chrome or matt grained lacquer in standard colours at standard price. Powder coating in RAL 9006 aluminium in special colours at an additional price - shown for each product in the price list.