

# Statligt Ramavtal - Möbler och inredning

Delområde - Möten och paus

Ramavtalsnummer 23.3-5834-2022-007

## Howe - Produktlista nr 1



**Kinnarps®**

**20 % rabatt ska dras av på angivna priser.**

## Kinnarps AB

521 88 Kinnarp  
0515 - 380 00

## Kontakt avtalsfrågor

Fredrik Ek  
0515 - 380 59

## E-postadress för avrop

avrop.kammarkollegiet@kinnarps.se

## Kinnarps Showrooms

<b>ARVIKA</b>	Blåstervägen 3 671 41 ARVIKA 0570-71 17 70	<b>KIRUNA</b>	Triangelvägen 2 981 38 KIRUNA 0980-804 00	<b>SUNDSVALL</b>	Tegelvägen 18 853 50 SUNDSVALL 060- 14 48 40
<b>BORÅS</b>	Företagsgatan 14 (Viared) 504 64 BORÅS 033-44 73 73	<b>KRISTIANSTAD</b>	Karlgatan 45 291 59 KRISTIANSTAD 044-10 10 10	<b>SÖDERTÄLJE</b>	Hantverksvägen 10 151 65 SÖDERTÄLJE 08-550 664 55
<b>FALUN</b>	Krontallsvägen 28 791 55 FALUN 0771-750 760	<b>LIDKÖPING</b>	Garpgatan 6 531 33 LIDKÖPING 0510-132 90	<b>TROLLHÄTTAN</b>	Betongvägen 11 461 38 TROLLHÄTTAN 0520-48 85 85
<b>GISLAVED</b>	Regeringsgatan 14 332 30 GISLAVED 0371-58 69 00	<b>LINKÖPING</b>	Gillbergsgatan 42 582 73 LINKÖPING 013-36 48 00	<b>UMEÅ</b>	Cementvägen 16 906 21 UMEÅ 090-18 17 00
<b>GÄVLE</b>	Södra Skeppsbron 17 802 84 GÄVLE 0771-750 760	<b>LJUNGBY</b>	Gängesvägen 6 341 31 LJUNGBY 0470-702330	<b>UPPSALA</b>	Sylveniusgatan 4 754 50 UPPSALA 018-65 17 00
<b>GÖTEBORG</b>	Ebbe Lieberathsgatan 30 412 65 GÖTEBORG 031-703 27 00	<b>LULEÅ</b>	Ödlegatan 1A 973 34 LULEÅ 0920-101 70	<b>VARBERG</b>	Norrkatan 3 432 41 VARBERG 0340-59 17 01
<b>HALMSTAD</b>	Fyllebrovägen 16 302 60 HALMSTAD 035-17 74 70	<b>LYCKSELE</b>	Umevägen 1 921 45 LYCKSELE 070 - 220 08 75	<b>VISBY</b>	Skarphällsgatan 13 621 41 VISBY 0498-657500
<b>HELSINGBORG</b>	Garnisonsgatan 22 254 66 HELSINGBORG 042-38 83 00	<b>MALMÖ</b>	Östra Hindbyvägen 63 213 74 MALMÖ 040-14 34 20	<b>VÄSTERVIK</b>	Storgatan 39 593 33 VÄSTERVIK 0490-102 00
<b>HUDIKSVALL</b>	Rönningevägen 2 824 34 HUDIKSVALL 0650-991 91	<b>MOTALA</b>	Vintergatan 8 591 32 MOTALA 0141-21 36 76	<b>VÄSTERÅS</b>	Lysgränd 3 721 30 VÄSTERÅS 021-10 82 00
<b>JÖNKÖPING</b>	Huskvarnavägen 80 554 54 JÖNKÖPING 036-36 46 00	<b>NORRKÖPING</b>	Koppargatan 24 602 23 NORRKÖPING 011-31 30 00	<b>VÄXJÖ</b>	Sandvägen 8 352 45 VÄXJÖ 0470-702330
<b>KALMAR</b>	Dagövägen 3 393 54 KALMAR 0480-880 50	<b>NYKÖPING</b>	Gumsbackevägen 12 611 38 NYKÖPING 0155-20 58 10	<b>ÖREBRO</b>	Fabriksgatan 47 702 23 ÖREBRO 010-499 80 00
<b>KARLSKRONA</b>	Järavägen 6 371 49 KARLSKRONA 0455-30 75 30	<b>SKELLEFTEÅ</b>	Anders Torg 2 931 57 SKELLEFTEÅ 0910-568 00	<b>ÖRNSKÖLDSVIK</b>	Terminalvägen 9E 891 51 ÖRNSKÖLDSVIK 0660-812 00
<b>KARLSTAD</b>	Körkarlsvägen 5 653 46 KARLSTAD 054-808900	<b>SKÖVDE</b>	Norra Aspelundsvägen 1A 541 34 SKÖVDE 0500-44 51 30	<b>ÖSTERSUND</b>	Splintvägen 3 831 72 ÖSTERSUND 063-57 11 50
<b>KINNARP</b>	Industrigatan 14 521 73 KINNARP 0515-380 00	<b>STOCKHOLM</b>	Fannys Väg 5 131 54 NACKA 08-556 910 00		

**20 % rabatt ska dras av på angivna priser.**

# Table of Content

## Chairs

### 40/4

Side chair

Side chair - upholstered

Arm chair

Arm chair - upholstered

Swivel

Swivel - upholstered

Bar and Lounge

Metal and Wood

### SixE

4-leg

4-leg on castors

Sled

Barstool

Swivel

Learn

### AS100

Accessories for chairs

Notes for chairs

## Upholstery collection

20 % rabatt ska dras av på angivna priser.

# Table of Content

## Tables

---

### Moveo

---

Training

---

Meeting

---

Conference, modular

---

Conference, stand alone

---

Modesty panel

---

### Simpla

---

Tables

---

Modesty panel

---

### Tempest

---

Flip top

---

Flip top café

---

Flip top bar

---

Fold

---

Fix

---

Fix bar

---

Fix café and lounge

---

Modesty panel

---

### Tutor

---

### Usu

---

### AS table series

---

AS400

---

AS500

---

Other accessories for tables

---

Notes for tables

---

Finish overview

---



20 % rabatt ska dras av på angivna priser.









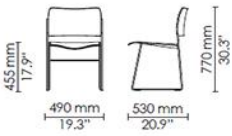

# 40/4 side chair - polyamide

By David Rowland

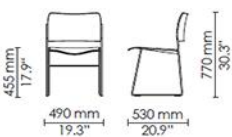
Most people see the 40/4 as a pioneering design that has stood the test of time. We like to think of it as a legacy that continues to move you in new ways.

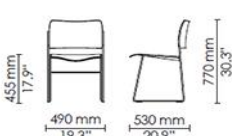
- 10 year warranty
- Stacks 40 chairs on a dolly
- EN 15373 / ANSI/BIFMA X5.1 – N7.1
- FSC/PEFC certified
- ISO 14025 EPD
- GreenTag<sup>Cert™</sup>
- Health Product Declaration (HPD)
- **Quick ship - LINK**

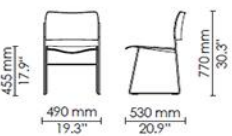

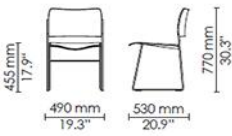
		POLYAMIDE (DPA)	
STANDARD FRAME COLOURS		PA200 ● PA100 ●	PA110 ●
 B1 B6 B7 B9 B10 B30		PA300 ○	PA250 ●
RAL K5 colours available at customer request		PA260 ●	PA320 ●
		PA360 ●	PA380 ●
		PA370 ●	SEK
		SEK	SEK
Non linking (RA)	6,5 kg		
		3051	3295
Brace linking (BA)	6,6 kg		
		3468	3712
Eye Hook linking (EA)	6,6kg		
		3468	3712
Dining height (DA)*	6,5 kg		
		3341	3585
*Different seat angle compared to regular chair			
Side chair outdoor (DOARA)	6,5 kg		
		4559	4803

Felt glides	128	SEK
Fee per RAL K5 colour for frames (for one colour if below 200 pcs)	+2550	SEK

Price list 2024 - SEK excl. V.A.T. - Version 1.0

20 % rabatt ska dras av på angivna priser.

# 40/4 side chair upholstered

By David Rowland

Most people see the 40/4 as a pioneering design that has stood the test of time. We like to think of it as a legacy that continues to move you in new ways.

- 10 year warranty
- Stacks 25 chairs on a dolly
- EN 16139 / Ansi/Bifma X5.1
- FSC/PEFC certified
- ISO 14025 EPD
- GreenTag<sup>Cert™</sup>
- **Quick ship - LINK**



## STANDARD FRAME COLOURS

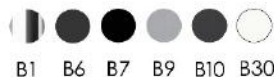

RAL K5 colours available at customer request

Non linking (RA) 6,3 kg

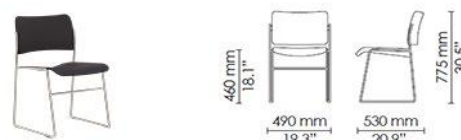

Brace linking (BA) 6,5 kg

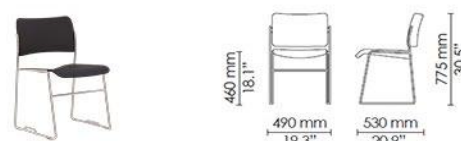

Eye Hook linking (EA) 6,5 kg

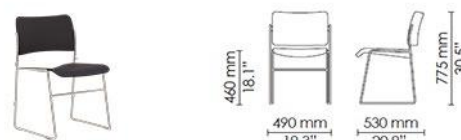

Dining height (DA)\* 6,3 kg

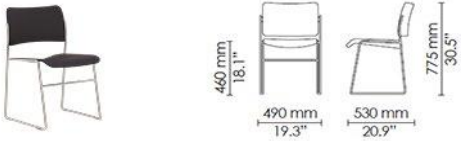

\*Different seat angle compared to regular chair

GROUP	SEAT UPHOLSTERED		FULLY UPHOLSTERED (DUA)
	POLYAMIDE (DSA)		
	PA200 ●	PA100 ●	
	PA300 ○	PA110 ●	
		PA250 ●	
		PA260 ●	
		PA320 ●	
		PA360 ●	
		PA380 ●	
		PA370 ●	
	SEK	SEK	SEK
<b>COM</b>	3909	4060	4431
<b>1</b>	4153	4304	4779
<b>2</b>	4477	4628	5243
<b>3</b>	4791	4942	5695
<b>4</b>	5266	5417	6380
<b>5</b>	5429	5580	6600
<b>COL</b>	4895	5046	5846
<b>LUBL</b>	5266	5417	6380
<b>LUCL</b>	5904	6055	7285
<b>LSL</b>	6913	7064	8723
<b>COM</b>	4327	4478	4860
<b>1</b>	4571	4722	5208
<b>2</b>	4895	5046	5672
<b>3</b>	5209	5360	6124
<b>4</b>	5684	5835	6809
<b>5</b>	5847	5998	7029
<b>COL</b>	5313	5464	6275
<b>LUBL</b>	5684	5835	6809
<b>LUCL</b>	6322	6473	7714
<b>LSL</b>	7331	7482	9152
<b>COM</b>	4327	4478	4860
<b>1</b>	4571	4722	5208
<b>2</b>	4895	5046	5672
<b>3</b>	5209	5360	6124
<b>4</b>	5684	5835	6809
<b>5</b>	5847	5998	7029
<b>COL</b>	5313	5464	6275
<b>LUBL</b>	5684	5835	6809
<b>LUCL</b>	6322	6473	7714
<b>LSL</b>	7331	7482	9152
<b>COM</b>	4188	4339	4721
<b>1</b>	4432	4583	5069
<b>2</b>	4756	4907	5533
<b>3</b>	5070	5221	5985
<b>4</b>	5545	5696	6670
<b>5</b>	5708	5859	6890
<b>COL</b>	5174	5325	6136
<b>LUBL</b>	5545	5696	6670
<b>LUCL</b>	6183	6334	7575
<b>LSL</b>	7192	7343	9013

Price list 2024 - SEK excl. V.A.T. - Version 1.0

Felt glides 128 SEK

Fee per RAL K5 colour for frames +2550 SEK  
(for one colour if below 200 pcs)

20 % rabatt ska dras av på angivna priser.

# 40/4 armchair - polyamide

By David Rowland

Most people see the 40/4 as a pioneering design that has stood the test of time. We like to think of it as a legacy that continues to move you in new ways.

- 10 year warranty
- Stacks 40 chairs on a dolly
- EN 15373 / ANSI/BIFMA X5.1 – N7.1
- FSC/PEFC certified
- ISO 14025 EPD
- GreenTag<sup>Cert™</sup>
- 27% recycled plastic
- **Quick ship - LINK**



POLYAMIDE (DPB)

STANDARD FRAME COLOURS



RAL K5 colours available at customer request

- |         |         |
|---------|---------|
| PA200 ● | PA100 ● |
| PA300 ○ | PA110 ● |
|         | PA250 ● |
|         | PA260 ● |
|         | PA320 ● |
|         | PA360 ● |
|         | PA380 ● |
|         | PA370 ● |
| SEK     | SEK     |

Non linking (RA)	7,7 kg		
		4222	4466
Dining height (DA)*	7,7 kg		
		4512	4756
*Different seat angle compared to regular chair			
Armlinking (J)	7,8 kg		
		4906	5150
Armchair outdoor (DOBRA)	7,7 kg		
		5730	5974

Price list 2024 - SEK excl. V.A.T. - Version 1.0

Felt glides	128	SEK
Table surface protection	+120	SEK
Fee per RAL K5 colour for frames (for one colour if below 200 pcs)	+2550	SEK

20 % rabatt ska dras av på angivna priser.

# 40/4 armchair upholstered

By David Rowland

Most people see the 40/4 as a pioneering design that has stood the test of time. We like to think of it as a legacy that continues to move you in new ways.

- 10 year warranty
- Stacks 25 chairs on a dolly
- EN 15373 / ANSI/BIFMA X5.1 – N7.1
- FSC/PEFC certified
- ISO 14025 EPD
- GreenTag<sup>Cert™</sup>
- **Quick ship - LINK**



## STANDARD FRAME COLOURS



RAL K5 colours available at customer request

Non linking (RA) 7,6 kg

Dining height (DA)\* 7,6 kg

\*Different seat angle compared to regular chair

Armlinking (J) 7,7 kg

GROUP	SEAT UPHOLSTERED		FULLY UPHOLSTERED		
	POLYAMIDE (DSB)		UPHOLSTERED (DUB)		
	PA200 PA300	PA100 PA110 PA250 PA260 PA320 PA360 PA380 PA370	BLACK POLYAMIDE ARMREST	BLACK STAINED VENEER ARMREST	UPH. ARMRESTS
	SEK	SEK	SEK	SEK	SEK
<b>COM</b>	5081	5232	5603	6067	6067
<b>1</b>	5325	5476	5951	6415	6566
<b>2</b>	5649	5800	6415	6879	7134
<b>3</b>	5963	6114	6867	7331	7667
<b>4</b>	6438	6589	7552	8016	8422
<b>5</b>	6601	6752	7772	8236	8781
<b>COL</b>	6067	6218	7018	7482	7749
<b>LUBL</b>	6438	6589	7552	8016	8422
<b>LUCL</b>	7076	7227	8457	8921	9710
<b>LSL</b>	8085	8236	9895	10359	11264
<b>COM</b>	5359	5510	5893	6357	6357
<b>1</b>	5603	5754	6241	6705	6856
<b>2</b>	5927	6078	6705	7169	7424
<b>3</b>	6241	6392	7157	7621	7957
<b>4</b>	6716	6867	7842	8306	8712
<b>5</b>	6879	7030	8062	8526	9071
<b>COL</b>	6345	6496	7308	7772	8039
<b>LUBL</b>	6716	6867	7842	8306	8712
<b>LUCL</b>	7354	7505	8747	9211	10000
<b>LSL</b>	8363	8514	10185	10649	11554
<b>COM</b>	5765	5916	6287	6751	6751
<b>1</b>	6009	6160	6635	7099	7250
<b>2</b>	6333	6484	7099	7563	7818
<b>3</b>	6647	6798	7551	8015	8351
<b>4</b>	7122	7273	8236	8700	9106
<b>5</b>	7285	7436	8456	8920	9465
<b>COL</b>	6751	6902	7702	8166	8433
<b>LUBL</b>	7122	7273	8236	8700	9106
<b>LUCL</b>	7760	7911	9141	9605	10394
<b>LSL</b>	8769	8920	10579	11043	11948

Price list 2024 - SEK excl. V.A.T. - Version 1.0

Felt glides	128	SEK
Table surface protection	+120	SEK
Fee per RAL K5 colour for frames (for one colour if below 200 pcs)	+2550	SEK
Fee per RAL K5 colour for veneer (for one colour if below 200 pcs)	+1160	SEK

20 % rabatt ska dras av på angivna priser.



# 40/4 swivel - polyamide

By David Rowland

Most people see the 40/4 as a pioneering design that has stood the test of time. We like to think of it as a legacy that continues to move you in new ways.

- 10 year warranty
- Castors or glides available
- Height adjustable
- Soft lane castor as an option
- FSC/PEFC certified
- GreenTag<sup>Cert™</sup>
- 39% recycled plastic



STANDARD FRAME COLOURS		POLYAMIDE (DP)	
<p>B1 B6 B7 B9 B10 B30</p>		PA200 ● PA100 ● PA300 ○ PA110 ● PA250 ● PA260 ● PA320 ● PA360 ● PA380 ● PA370 ● SEK SEK	
RAL K5 colours available at customer request			
Side chair (DPESS)	11,6 kg		
		5684	5928
Armchair (DPFSA)	12,4 kg		
		6867	7111

Price list 2024 - SEK excl. V.A.T. - Version 1.0

Soft lane castors	128	SEK
Fee per RAL K5 colour for frames (for one colour if below 200 pcs)	+2550	SEK

20 % rabatt ska dras av på angivna priser.

# 40/4 swivel upholstered

By David Rowland

Most people see the 40/4 as a pioneering design that has stood the test of time. We like to think of it as a legacy that continues to move you in new ways.

- 10 year warranty
- Castors or glides available
- Height adjustable
- Soft lane castor as an option
- FSC/PEFC certified
- ISO 14025 EPD
- GreenTag<sup>Cert™</sup>

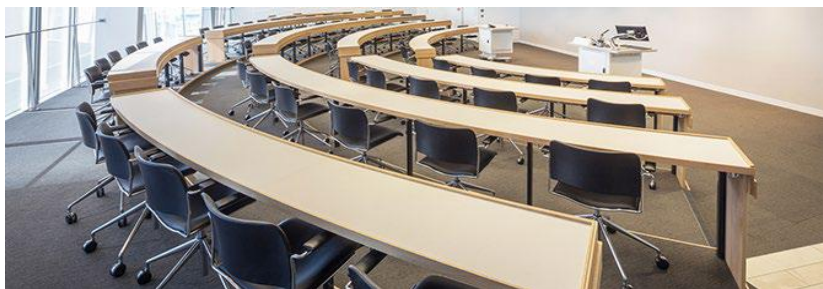

## STANDARD FRAME COLOURS



RAL K5 colours available at customer request

## Side chair (DUSS)

11,4 kg



470 - 595 mm  
18.5" - 23.4"



775 - 900 mm  
30.5" - 35.4"

660 mm  
26"

## Armchair (DUFSA)

12,2 kg



675 - 800 mm  
26.6" - 31.5"

470 - 595 mm  
18.5" - 23.4"



775 - 900 mm  
30.5" - 35.4"

660 mm  
26"

GROUP	SEAT UPHOLSTERED		FULLY UPHOLSTERED (DU)		
	POLYAMIDE (DS)		BLACK POLYAMIDE ARMREST	BLACK STAINED VENEER ARMREST	W-W/O UPH. ARM
	PA200 ●	PA100 ●			
	PA300 ○	PA110 ●			
		PA250 ●			
		PA260 ●			
		PA320 ●			
		PA360 ●			
		PA380 ●			
		PA370 ●			
	SEK	SEK	SEK	SEK	SEK
<b>COM</b>	6542	6693	N/A	N/A	7076
<b>1</b>	6786	6937	N/A	N/A	7424
<b>2</b>	7110	7261	N/A	N/A	7888
<b>3</b>	7424	7575	N/A	N/A	8340
<b>4</b>	7899	8050	N/A	N/A	9025
<b>5</b>	8062	8213	N/A	N/A	9245
<b>COL</b>	7528	7679	N/A	N/A	8491
<b>LUBL</b>	7899	8050	N/A	N/A	9025
<b>LUCL</b>	8537	8688	N/A	N/A	9930
<b>LSL</b>	9546	9697	N/A	N/A	11368
<b>COM</b>	7714	7865	8248	8712	8712
<b>1</b>	7958	8109	8596	9060	9211
<b>2</b>	8282	8433	9060	9524	9779
<b>3</b>	8596	8747	9512	9976	10312
<b>4</b>	9071	9222	10197	10661	11067
<b>5</b>	9234	9385	10417	10881	11426
<b>COL</b>	8700	8851	9663	10127	10394
<b>LUBL</b>	9071	9222	10197	10661	11067
<b>LUCL</b>	9709	9860	11102	11566	12355
<b>LSL</b>	10718	10869	12540	13004	13909

Price list 2024 - SEK excl. V.A.T. - Version 1.0

Soft lane castors	128	SEK
Fee per RAL K5 colour for frames (for one colour if below 200 pcs)	+2550	SEK
Fee per RAL K5 colour for veneer (for one colour if below 200 pcs)	+1160	SEK

20 % rabatt ska dras av på angivna priser.

# 40/4 barstool and lounge chair

By David Rowland

Most people see the 40/4 as a pioneering design that has stood the test of time. We like to think of it as a legacy that continues to move you in new ways.

- 10 year warranty
- Stacks 10 barstools
- Stacks 20 lounge chairs
- EN 15373 / ANSI/BIFMA X5.1
- FSC/PEFC certified
- ISO 14025 EPD
- GreenTag<sup>Cert™</sup>



	POLYAMIDE		FULLY UPHOLSTERED	
STANDARD FRAME COLOURS	PA200 ● PA300 ○	PA100 ● PA110 ● PA250 ● PA260 ● PA320 ● PA360 ● PA380 ● PA370 ●	GROUP	PRICE
	SEK	SEK		SEK
<b>Lounge chair (DVdra)</b> 6 kg 	N/A	N/A	<b>COM</b>	6136
<b>Barstool (DPCAA)</b> 10,4 kg 	5614	5858	<b>1</b>	7354
<b>Barstool counter height (DPCCA)</b> 9,2 kg 	5614	5858	<b>2</b>	7818
<b>Barstool outdoor (DOCCA)</b> 10,4 kg 	7134	7378	<b>3</b>	8270
			<b>4</b>	8955
			<b>5</b>	9175
			<b>COL</b>	8421
			<b>LUBL</b>	8955
			<b>LUCL</b>	9860
			<b>LSL</b>	11298
			<b>COM</b>	7006
			<b>1</b>	7354
			<b>2</b>	7818
			<b>3</b>	8270
			<b>4</b>	8955
			<b>5</b>	9175
			<b>COL</b>	8421
			<b>LUBL</b>	8955
			<b>LUCL</b>	9860
			<b>LSL</b>	11298

Price list 2024 - SEK excl. V.A.T. - Version 1.0

Felt glides	128	SEK
Fee per RAL K5 colour for frames (for one colour if below 200 pcs)	+2550	SEK
Fee per RAL K5 colour for veneer (for one colour if below 200 pcs)	+1160	SEK

20 % rabatt ska dras av på angivna priser.





# 40/4 metal

By David Rowland

Most people see the 40/4 as a pioneering design that has stood the test of time. The 40/4 wood frame is an alternative to the original chair with its iconic steel rod sled frame

- 10 year warranty
- Stacks 25 chairs with wood frame
- Stacks 40 chairs in metal
- Wood frame also with seat upholstered
- EN 16139 (wood frame)
- FSC/PEFC certified
- GreenTag<sup>Cert™</sup>

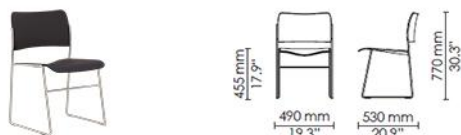

		METAL (DMA)
		ME200  ME300  ME110 
		SEK
Metal non linking (DMA-N)	8,5 kg	4454
		
Metal w/ linking (DMA-Y)	8,6 kg	4686
		

Price list 2024 - SEK excl. V.A.T. - Version 1.0

Felt glides	128	SEK
Fee per RAL K5 colour for frames (for one colour if below 200 pcs)	+2550	SEK

20 % rabatt ska dras av på angivna priser.

**HOWE**

# SixE 4-leg

By PearsonLloyd

No matter how you look at SixE, it presents itself as a perfectly bold move – bending the rules of how comfortable a simple polypropylene shell chair can be.

- 10 year warranty
- SixE stacks up to 25 chairs on a dolly
- GreenTag<sup>Cert™</sup>
- **Quick ship - LINK**
- Shells from recycled plastic available



Standard frame colours:  B1 B6 B7 B9 B10 B30 Choose matching frame and shell colour without additional costs: 	POLYPROPYLENE (EPAMA/EPBMA)		UPHOLSTERY				
	PP200	● PP100 ● ○ PP300 ○ ● PP310 ● ● PP270 ● ● PP120 ● ● PP340 ● ● PP350 ●  RECYCLED PP100 ●	GROUP	SEAT UPH.		FULLY UPH.	
				BLACK (EFA/ EFB)	COLOUR (EFA/ EFB)	NO ARM (EUA)	BLACK ARM (EUB)
RAL K5 colours available at customer request	SEK	SEK		SEK	SEK	SEK	SEK
Sidechair (EPAMA) 5 kg	2540	2830	COM	3921	4211	6426	N/A
			1	4107	4397	7006	N/A
			2	4315	4605	7598	N/A
			3	4466	4756	8062	N/A
			4	4721	5011	8839	N/A
			5	4977	5267	9581	N/A
			COL	4594	4884	N/A	N/A
			LUBL	4721	5011	N/A	N/A
			LUCL	5336	5626	N/A	N/A
			LSL	5997	6287	N/A	N/A
Sidechair with Quicklinking (EPAMA-R) 5 kg	3004	3294	COM	4385	4675	6890	N/A
			1	4571	4861	7470	N/A
			2	4779	5069	8062	N/A
			3	4930	5220	8526	N/A
			4	5185	5475	9303	N/A
			5	5441	5731	10045	N/A
			COL	5058	5348	N/A	N/A
			LUBL	5185	5475	N/A	N/A
			LUCL	5800	6090	N/A	N/A
			LSL	6461	6751	N/A	N/A
Armchair (EPBMA) 5,7 kg	3294	3584	COM	4733	5023	N/A	7169
			1	4919	5209	N/A	7749
			2	5127	5417	N/A	8341
			3	5278	5568	N/A	8805
			4	5533	5823	N/A	9582
			5	5789	6079	N/A	10324
			COL	5406	5696	N/A	N/A
			LUBL	5533	5823	N/A	N/A
			LUCL	6148	6438	N/A	N/A
			LSL	6809	7099	N/A	N/A
Armchair with armlinking (EPBMA-Y) 5,7 kg	3422	3712	COM	4861	5151	N/A	7297
			1	5047	5337	N/A	7877
			2	5255	5545	N/A	8469
			3	5406	5696	N/A	8933
			4	5661	5951	N/A	9710
			5	5917	6207	N/A	10452
			COL	5534	5824	N/A	N/A
			LUBL	5661	5951	N/A	N/A
			LUCL	6276	6566	N/A	N/A
			LSL	6937	7227	N/A	N/A

Price list 2024 - SEK excl. V.A.T. - Version 1.0

Felt glides 128 SEK

Fee per RAL K5 colour for frames (for one colour if below 200 pcs) +2550 SEK

20 % rabatt ska dras av på angivna priser.





# SixE 4-leg on castors

By PearsonLloyd

No matter how you look at SixE,  
it presents itself as a perfectly bold move  
– bending the rules of how comfortable  
a simple polypropylene shell chair can be.

- 10 year warranty
- SixE stacks up to 15 chairs on a dolly
- GreenTag<sup>Cert™</sup>
- Shells from recycled plastic available



Standard frame colours:  B1 B6 B7 B9 B10 B30 Choose matching frame and shell colour without additional costs: 	POLYPROPYLENE (EPASB/EPBSD)		UPHOLSTERY					
	PP200 ●	PP100 ● PP300 ○ PP310 ● PP270 ● PP120 ● PP340 ● PP350 ●	RECYCLED PP100 ●	GROUP	SEAT UPH.		FULLY UPH.	
					BLACK (EFA/ EFB)	COLOUR (EFA/ EFB)	NO ARM (EUA)	BLACK ARM (EUB)
RAL K5 colours available at customer request	SEK	SEK			SEK	SEK	SEK	SEK
Sidechair (EPASB) 5,2 kg 	3956	4246		<b>COM</b>	5464	5754	7830	N/A
				<b>1</b>	5650	5940	8410	N/A
				<b>2</b>	5858	6148	9002	N/A
				<b>3</b>	6009	6299	9466	N/A
				<b>4</b>	6264	6554	10243	N/A
				<b>5</b>	6520	6810	10985	N/A
				<b>COL</b>	6137	6427	N/A	N/A
				<b>LUBL</b>	6264	6554	N/A	N/A
				<b>LUCL</b>	6879	7169	N/A	N/A
				<b>LSL</b>	7540	7830	N/A	N/A
Armchair (EPBSD) 6,1 kg 	4698	4988		<b>COM</b>	6276	6566	N/A	8584
				<b>1</b>	6462	6752	N/A	9164
				<b>2</b>	6670	6960	N/A	9756
				<b>3</b>	6821	7111	N/A	10220
				<b>4</b>	7076	7366	N/A	10997
				<b>5</b>	7332	7622	N/A	11739
				<b>COL</b>	6949	7239	N/A	N/A
				<b>LUBL</b>	7076	7366	N/A	N/A
				<b>LUCL</b>	7691	7981	N/A	N/A
				<b>LSL</b>	8352	8642	N/A	N/A

Price list 2024 - SEK excl. V.A.T. - Version 1.0

Soft lane castors 128 SEK

Fee per RAL K5 colour for frames  
(for one colour if below 200 pcs) +2550 SEK

20 % rabatt ska dras av på angivna priser.

# SixE sled

By PearsonLloyd

No matter how you look at SixE, it presents itself as a perfectly bold move – bending the rules of how comfortable a simple polypropylene shell chair can be.

- 10 year warranty
- SixE stacks up to 25 chairs on a dolly
- GreenTag<sup>Cert™</sup>
- **Quick ship - LINK**
- Shells from recycled plastic available



Photo: Steve Hall / Architect: Eastlake Studio

	POLYPROPYLENE (EPA/EPB)		UPHOLSTERY				
	PP200	<ul style="list-style-type: none"> <li>● PP100</li> <li>● PP300</li> <li>● PP310</li> <li>● PP270</li> <li>● PP120</li> <li>● PP340</li> <li>● PP350</li> <li>● RECYCLED PP100</li> </ul>	GROUP	SEAT UPH.		FULLY UPH.	
				BLACK (EFA/EFB)	COLOUR (EFA/EFB)	NO ARM (EUA)	BLACK ARM (EUB)
<p>Standard frame colours:</p> <p>B1 B6 B7 B9 B10 B30</p> <p>Choose matching frame and shell colour without additional costs:</p> <p>RAL K5 colours available at customer request</p>	SEK	SEK		SEK	SEK	SEK	SEK
<p>Sidechair (EPARB) 6 kg</p>	3086	3376	COM	4536	4826	6972	N/A
<p>Sidechair with bracelinking (EPABB) 6,2 kg</p>	3561	3851	1	5220	5510	8027	N/A
<p>Armchair (EPBRB) 7,3 kg</p>	3840	4130	2	5428	5718	8619	N/A
<p>Armchair with armlinking (EPBRB-Y) 7,3 kg</p>	3968	4258	3	5579	5869	9083	N/A
			4	5834	6124	9860	N/A
			5	6090	6380	10602	N/A
			COL	5707	5997	N/A	N/A
			LUBL	5834	6124	N/A	N/A
			LUCL	6449	6739	N/A	N/A
			LSL	7110	7400	N/A	N/A
			COM	5348	5638	N/A	7714
			1	5534	5824	N/A	8294
			2	5742	6032	N/A	8886
			3	5893	6183	N/A	9350
			4	6148	6438	N/A	10127
			5	6404	6694	N/A	10869
			COL	6021	6311	N/A	N/A
			LUBL	6148	6438	N/A	N/A
			LUCL	6763	7053	N/A	N/A
			LSL	7424	7714	N/A	N/A
			COM	5476	5766	N/A	7842
			1	5662	5952	N/A	8422
			2	5870	6160	N/A	9014
			3	6021	6311	N/A	9478
			4	6276	6566	N/A	10255
			5	6532	6822	N/A	10997
			COL	6149	6439	N/A	N/A
			LUBL	6276	6566	N/A	N/A
			LUCL	6891	7181	N/A	N/A
			LSL	7552	7842	N/A	N/A

Price list 2024 - SEK excl. V.A.T. - Version 1.0

Felt glides 128 SEK

Fee per RAL K5 colour for frames (for one colour if below 200 pcs) +2550 SEK

20 % rabatt ska dras av på angivna priser.



# SixE barstool

By PearsonLloyd

No matter how you look at SixE, it presents itself as a perfectly bold move – bending the rules of how comfortable a simple polypropylene shell chair can be.

- 10 year warranty
- SixE stacks up to 10 chairs on a dolly
- GreenTag<sup>Cert™</sup>
- Shells from recycled plastic available

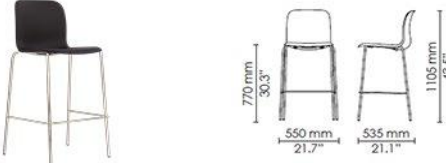
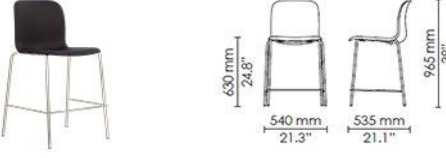
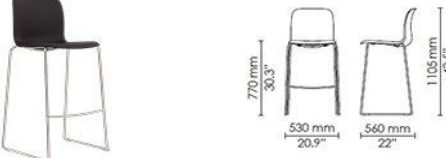

Standard frame colours:  Choose matching frame and shell colour without additional costs: 	POLYPROPYLENE (EPC)		UPHOLSTERY			
	PP200	<ul style="list-style-type: none"> <li>● PP100</li> <li>○ PP300</li> <li>● PP310</li> <li>● PP270</li> <li>● PP120</li> <li>● PP340</li> <li>● PP350</li> <li>● RECYCLED PP100</li> </ul>	GROUP	SEAT UPH.		FULLY UPH. (EUC)
				BLACK (EFC)	COLOUR (EFC)	
RAL K5 colours available at customer request	SEK	SEK		SEK	SEK	SEK
Barstool 4 Leg (EPCAO) 7,3 kg	4605	4895	COM	6148	6438	8468
			1	6334	6624	9048
			2	6542	6832	9640
			3	6693	6983	10104
			4	6948	7238	10881
			5	7204	7494	11623
			COL	6821	7111	N/A
			LUBL	6948	7238	N/A
			LUCL	7563	7853	N/A
			LSL	8224	8514	N/A
Barstool 4 Leg counter height (EPCAP) 5,2 kg	4605	4895	COM	6148	6438	8468
			1	6334	6624	9048
			2	6542	6832	9640
			3	6693	6983	10104
			4	6948	7238	10881
			5	7204	7494	11623
			COL	6821	7111	N/A
			LUBL	6948	7238	N/A
			LUCL	7563	7853	N/A
			LSL	8224	8514	N/A
Barstool Sled frame (EPCAM) 9,5 kg	5150	5440	COM	6763	7053	9025
			1	6949	7239	9605
			2	7157	7447	10197
			3	7308	7598	10661
			4	7563	7853	11438
			5	7819	8109	12180
			COL	7436	7726	N/A
			LUBL	7563	7853	N/A
			LUCL	8178	8468	N/A
			LSL	8839	9129	N/A

Price list 2024 - SEK excl. V.A.T. - Version 1.0

Felt glides 128 SEK

Fee per RAL K5 colour for frames (for one colour if below 200 pcs) +2550 SEK

20 % rabatt ska dras av på angivna priser.



# SixE swivel

By PearsonLloyd

No matter how you look at SixE, it presents itself as a perfectly bold move. – bending the rules of how comfortable a simple polypropylene shell chair can be.

- 10 year warranty
- Design for Disassembly
- GreenTag<sup>Cert™</sup>
- Shells from recycled plastic available

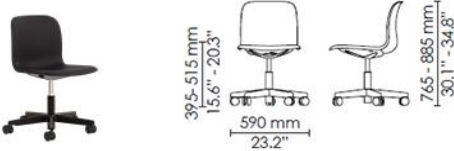
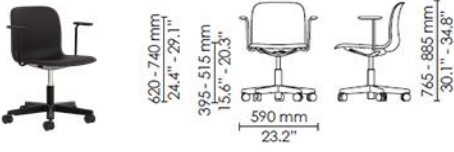

Standard frame colours:  ● B10 BAIN - HOWE Grey	POLYPROPYLENE (EPEES/EPFES)		UPHOLSTERY				
	PP200 ●	PP100 ● PP300 ○ PP310 ● PP270 ● PP120 ● PP340 ● PP350 ●	GROUP	SEAT UPH.		FULLY UPH. (EFSES/EFTES)	
				BLACK (EPO/ EPP)	COLOUR (EPO/ EPP)		
	SEK	SEK		SEK	SEK	SEK	
Sidechair  	7,2 kg	3596	3886	<b>COM</b> 1 2 3 4 5 COL LUBL LUCL LSL	5069 5255 5463 5614 5869 6125 5742 5869 6484 7145	5359 5545 5753 5904 6159 6415 6032 6159 6774 7435	7470 8050 8642 9106 9883 10625 N/A N/A N/A N/A
Armchair  	8,3 kg	4338	4628	<b>COM</b> 1 2 3 4 5 COL LUBL LUCL LSL	5881 6067 6275 6426 6681 6937 6554 6681 7296 7957	6171 6357 6565 6716 6971 7227 6844 6971 7586 8247	8224 8804 9396 9860 10637 11379 N/A N/A N/A N/A

Price list 2024 - SEK excl. V.A.T. - Version 1.0

Soft lane castors 128 SEK

20 % rabatt ska dras av på angivna priser.



# SixE Learn

By PearsonLloyd

No matter how you look at SixE, it presents itself as a perfectly bold move – bending the rules of how comfortable a simple polypropylene shell chair can be.

- 5 year warranty
- Design for Disassembly
- Chair for active learning environments, classrooms and higher education
- GreenTag<sup>Cert™</sup>
- Shells from recycled plastic available



Standard frame colours: B10 BAIN - HOWE Grey	POLYPROPYLENE (EPO/EPP)		UPHOLSTERY				
	PP200 ●	PP100 ● PP300 ○ PP310 ● PP270 ● PP120 ● PP340 ● PP350 ●	GROUP	SEAT UPH.		FULLY UPH. (EFQ/ EFR)	
				BLACK (EFO/ EFP)	COLOUR (EFO/ EFP)		
	SEK	SEK		SEK	SEK	SEK	
Learn side chair  660-780 mm / 26"-30.7" 395-515 mm / 15.6"-20.3" 720 mm / 28.3"	11,7 kg	6809	7053	<b>COM</b> 1 2 3 4 5 COL LUBL LUCL LSL	8584 8770 8978 9129 9384 9640 9257 9384 9999 10660	8828 9014 9222 9373 9628 9884 9501 9628 10243 10904	10695 11275 11867 12331 13108 13850 N/A N/A N/A N/A
Learn armchair  660-780 mm / 26"-30.7" 395-515 mm / 15.6"-20.3" 720 mm / 28.3"	12,7 kg	7563	7853	<b>COM</b> 1 2 3 4 5 COL LUBL LUCL LSL	9396 9582 9790 9941 10196 10452 10069 10196 10811 11472	9686 9872 10080 10231 10486 10742 10359 10486 11101 11762	11438 12018 12610 13074 13851 14593 N/A N/A N/A N/A

Price list 2024 - SEK excl. V.A.T. - Version 1.0

Soft lane castors	128	SEK
Bag hook*	313	SEK
Cupholder	278	SEK

20 % rabatt ska dras av på angivna priser.

# AS100

By Andreas Störiko

The AS series is highly inspired and highly functional. Combining elegance and utility with true mobility, the family of nesting chairs and tables leaves room for all imaginable purposes.

- 10 year warranty
- Lightweight and space-saving
- Easy to link multiple chairs for relocation
- Weight activated brake castors
- Stacks horizontally as many chairs as wanted
- FSC certified
- Return swivel mechanism with 4 positions



STANDARD ARMRESTS, SEATBAR AND BASE COLOURS



Side chair (CCS)

10 kg



Armchair (CCA)

10,9 kg



GROUP	FULLY UPHOLSTERED (DU)
	SEK
<b>COM</b>	10196
<b>1</b>	10660
<b>2</b>	11124
<b>3</b>	11681
<b>4</b>	12516
<b>5</b>	13050
<b>COL</b>	12168
<b>LUBL</b>	12516
<b>LUCL</b>	14859
<b>LSL</b>	17690
<b>COM</b>	11055
<b>1</b>	11519
<b>2</b>	11983
<b>3</b>	12540
<b>4</b>	13375
<b>5</b>	13909
<b>COL</b>	13027
<b>LUBL</b>	13375
<b>LUCL</b>	15718
<b>LSL</b>	18549

Price list 2024 - SEK excl. V.A.T. - Version 1.0

Soft castors for hard floors  128 SEK

20 % rabatt ska dras av på angivna priser.



# Accessories

## 40/4 Writing tablet

Most people see the 40/4 as a pioneering design that has stood the test of time. We like to think of it as a legacy that continues to move you in new ways.

All accessories are recommended for chrome frames only.



<b>Writing tablet without or with cupholder</b>		No.	Per Piece			
						SEK
Writing tablet without cupholder 40/4 writing tablet, chrome frame, 10 mm compact laminate Left and right version is available						
No Cupholder	Black	DAWS	2668			
No Cupholder	White	DAWS	2668			
Cupholder	Black	DAWS_Y	3016			
Cupholder	White	DAWS_Y	3016			
<b>40/4 and SixE Transporter for writing tablets</b>						
Writing tablet dolly, up to 18 pcs. Dolly with 3 boxes, length: 410 mm, depth: 610 mm, height: 1400 mm.					Per Transporter	SEK
Writing tablet dolly, up to 36 pcs. Double dolly with 6 boxes, length: 810 mm, depth: 610 mm, height: 1400 mm.						
18 Pcs	3 boxes				404WTDLY01	8120
36 pcs	6 boxes	404WTDLY02	16240			

Price list 2024 - SEK excl. V.A.T. - Version 1.0

20 % rabatt ska dras av på angivna priser.













# Accessories

## 40/4 Linking

Most people see the 40/4 as a pioneering design that has stood the test of time. We like to think of it as a legacy that continues to move you in new ways.

All accessories are recommended for chrome frames only.



LD linking	No.	Per Piece		
Width between seats: 65 mm. Linking side chair to side chair; allows to link chairs in a straight line.		SEK		
40/4 linking device LD1H in chrome	404ACCLD1H	464		
Width between seats: 125 mm. Linking: side chair to side chair; side chair to armchair; allows to link chairs in a straight line.				
40/4 linking device LD2H in chrome	404ACCLD2H	580		
Width between seats: 185 mm. Linking: side chair to side chair; side chair to armchair; armchair to armchair; allows to link chairs in a straight line.				
40/4 linking device LD3H in chrome	404ACCLD3H	638		
Width between seats: 80 mm. Linking side chair to side chair; allows to form the arc of chairs; the radius is adjustable, 0-12 degrees.				
40/4 radius linking device LD2RL in chrome	404ACCLD2R L	696		
Width between seats: 202 mm. Linking armchairs with writing tablets to armchairs with writing tablets; allows to link chairs in a straight line.				
40/4 linking device LD4S in chrome	404ACCLD4S	812		
Width between seats: 70 mm. Linking side chair to side chair; allows to link chairs in a straight line. Recommended for public spaces where EN 14703 is a requirement.				
40/4 safety linking device LD5S in chrome	404ACCLD5S	696		

Price list 2024 - SEK excl. V.A.T. - Version 1.0

20 % rabatt ska dras av på angivna priser.

# Accessories

## 40/4 Dolly and Glides

Most people see the 40/4 as a pioneering design that has stood the test of time. We like to think of it as a legacy that continues to move you in new ways.

All accessories are recommended for chrome frames only.



<b>Dollies</b>			No.	Per Piece
All accessories recommended for chrome frames only. Dollies suit side chairs and arm chairs in polyamide, veneer, or full upholstery. For dollies to other versions of the 40/4 chair - please ask HOWE				
Hook/eye, fin linking or without linking			DLYSSAASF10	7099
Brace linking or wood frame			DLYSSBCSF10	7099
Double dolly			DLYSD*	17052
Triple dolly			DLYST*	23154
Quatro dolly			DLYSQ*	26529
<b>Extra glides with felt</b>			No.	Per Piece
For hook/eye and fin-linking chairs on chrome frames				
Transparent female glides with felt with screws			02328WS	58
Transparent male glides with felt with screws			02329WS	58
Transparent regular glides with felt			02330	58
For non-linking chairs; for linking armchairs and for brace-linking side chairs				
Transparent regular glides with felt for both chrome and painted frames			02330	58
Transparent bar glides with felt for both chrome and painted frames			17330	58
<b>Extra glides without felt</b>			No.	Per Piece
For hook/eye and fin-linking chairs on chrome frames				
Transparent female glides without felt with screws			02325WS	46
Transparent male glides without felt with screws			02326WS	46
Transparent regular glides without felt			02339	46
For non-linking chairs; for linking armchairs and for brace-linking side chairs				
Transparent regular glides without felt for chrome frames			02339	46
Transparent regular glides without felt for painted frames			2327	46
Transparent bar glides with felt for both chrome and painted frames			17327	46



Price list 2024 - SEK excl. V.A.T. - Version 1.0

20 % rabatt ska dras av på angivna priser.

# Accessories

## 40/4 Linking items and book holders

Most people see the 40/4 as a pioneering design that has stood the test of time. We like to think of it as a legacy that continues to move you in new ways.

All accessories are recommended for chrome frames only.



LD linking continued		No.	Per Piece	
Width between seats: 70 mm. Linking side chair to side chair; allows to link chairs in a straight line. Recommended for public spaces where EN 14703 is a requirement.				
40/4 safety linking device LD55		404ACCLD55	696	
Cup holder for 40/4 safety linking device LD55		404ACCLD55 CUP	93	
Numbering for 40/4 safety linking device LD55		404ACCLD55 NUM	93	
Linking tool				
40/4 Linking tool  In chrome. An aid to the linking/unlinking operation of side chairs with integrated linking.				
Linking tool (for side chairs with integrated linking)		404ACC0300 101	580	
Row spacer bar  In HOWE grey powdercoating with rubber lock, allows a 350 mm aisle between rows.				
Row spacer bar for armchairs, 350 mm distance between the rows		404ACC027A 350	754	
Row spacer bar for side chairs, 350 mm distance between the rows		04ACC027S35	754	
Bookholders				
40/4 book rack in chrome				
Book rack (for side chairs and armchairs)		404ACC0290 101	1392	
Hymn book holder  In chrome, 120 mm high and 175 mm long; 154 mm wide (distance between front legs of chairs) with integrated linking. Note! Hymn book holder does not work with the writing tablet.				
Hymn book holder (for side chairs and armchairs, non-linking)		404ACC0280 101	812	

Price list 2024 - SEK excl. V.A.T. - Version 1.0

20 % rabatt ska dras av på angivna priser.

**HOWE**

# Accessories

## 40/4 Numbering tag

Most people see the 40/4 as a pioneering design that has stood the test of time. We like to think of it as a legacy that continues to move you in new ways.

All accessories are recommended for chrome frames only.



Numbering tags for row and seat	
The price of one numbering tag. The start-up fee is 300 SEK.	
40/4 Row/seat numbering tag	

No.	Per Piece
	SEK
404SN1120	464

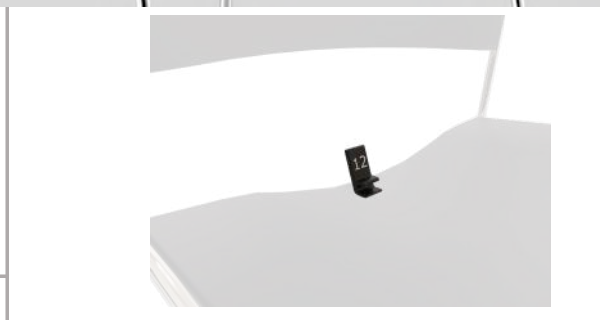

Price list 2024 - SEK excl. V.A.T. - Version 1.0

20 % rabatt ska dras av på angivna priser.





# Accessories

## SixE Writing tablet and Dolly

No matter how you look at SixE, it presents itself as a perfectly bold move – bending the rules of how comfortable a simple polypropylene shell chair can be.



<b>Writing tablet without or with cupholder</b>		No.	Per Piece
Writing tablet without cupholder SixE writing tablet, chrome frame, 10 mm compact laminate Left and right version is available			SEK
No Cupholder	Black	EAWS	2784
No Cupholder	White	EAWS	2784
Cupholder	Black	EAWS_Y	348
Cupholder	White	EAWS_Y	348
<b>40/4 and SixE Transporter for writing tablets</b>			
Writing tablet dolly, up to 18 pcs. Dolly with 3 boxes, length: 410 mm, depth: 610 mm, height: 1400 mm.			Per Transporter
Writing tablet dolly, up to 36 pcs. Double dolly with 6 boxes, length: 810 mm, depth: 610 mm, height: 1400 mm.			SEK
18 Pcs	3 boxes	404WTDLY01	8120
36 pcs	6 boxes	404WTDLY02	16240
<b>Dolly for SixE 4-leg and sled</b>			
Single HOWE grey dolly with multidirectional castors Accommodates up to 25 chairs.			Per Dolly
			SEK
25 chairs		22920010	11136



Price list 2024 - SEK excl. V.A.T. - Version 1.0

20 % rabatt ska dras av på angivna priser.

# Fabric suitability

Standard collection of the carefully selected fabrics suitable for the HOWE products. They were all thoroughly tested, therefore we can guarantee these textiles meet our highest standards. Please check here which fabrics are dedicated to each of our product. If you're looking for a solution that reaches beyond standard options, please contact HOWE Customer Service.



Supplier	Fabric's name	Supplier's fabric card EMEA	40/4	Munkegaard	SixE	Tongue	AS100	Price gr.Sweden
Gabriel	Cura	link	✓	✓	✓	✓	✓	1
Gabriel	Event	link	✓	✓	✓	✓	✓	1
Gabriel	Fighter	link	✓	X		X		1
Camira	Main Line Plus	link	✓	X	✓	✓	✓	1
Camira	Oceanic	link	✓	✓	✓	✓	X	1
Camira	Rivet	link	✓	✓	✓	✓	X	1
Gabriel	Step	link	✓	X	✓	X	X	1
Gabriel	Step Melange	link	✓	✓	✓	X	✓	1
Camira	Main Line Flax	link	✓	✓	✓	✓	✓	2
Gabriel	Crisp	link	✓		✓	X	✓	3
Gabriel	Fame	link	✓	X	✓	X	✓	3
Kvadrat	Steelcut Trio 3	link	✓	X	✓	X	✓	5

✓ - fabric suitable for the product  
 X - fabric not suitable for the product  
 blank window - fabric requires testing

20 % rabatt ska dras av på angivna priser.

# Fabric suitability

Standard collection of the carefully selected fabrics suitable for the HOWE products. They were all thoroughly tested, therefore we can guarantee these textiles meet our highest standards. Please check here which fabrics are dedicated to each of our product. If you're looking for a solution that reaches beyond standard options, please contact HOWE Customer Service.



Supplier	Fabric's name	Composition	Mattindale	Flammability CAL 117	Added flame retardant	Flammability M	Washable	Cleanable	Ecolabel	Oeko-Tex
Gabriel	Cura	98% post-consumer recycled polyester, 2% polyester	100000	YES	NO	NO	60-74°C	YES	✓	✓
Gabriel	Event	100% polyester	100000	YES	NO	NO	60°C	YES	✓	✓
Gabriel	Fighter	100% recyclable polyester	130 000	YES	NO	NO	YES	only dry	NO	✓
Camira	Main Line Plus	67% Wool, 20% Flame Retardant Viscose, 13% Viscose	≥50,000	NO	YES	NO	YES	YES	NO	✓
Camira	Oceanic	100% post-consumer recycled polyester	≥100,000	YES	NO	NO	60°C	YES	✓	✓
Camira	Rivet	100% post-consumer recycled polyester	≥80,000	YES	NO	NO	60°C	YES	✓	NO
Gabriel	Step	100% Trevira cs	100 000	YES	YES	M1	60-74°C	YES	✓	✓
Gabriel	Step Melange	100% Trevira cs	100 000	YES	YES	M1	60-74°C	YES	✓	✓
Camira	Main Line Flax	70% Virgin Wool, 30% Flax	≥50,000	YES	NO	NO	NO	YES	✓	NO
Gabriel	Crisp	93% wool, 7% polyamide	200 000	YES	NO	M1	NO	YES	✓	✓
Gabriel	Fame	95% wool, 5% polyamide	200 000	YES	NO	NO	NO	only dry	✓	✓
Kvadrat	Steelcut Trio 3	90% New wool, 10% Nylon	100 000	YES	NO	NO	NO	only dry	✓	NO

20 % rabatt ska dras av på angivna priser.

# Moveo Training

By Justus Kolberg & Erik Simonsen

Easy to move thanks to a light frame, Moveo is even more flexible than your calendar. Optimum mobility is ensured by the perfectly designed wheels.

- 10 year warranty
- GreenTag<sup>Cert™</sup>
- FSC certified
- PEFC certified
- C-leg style
- Flip top table system
- 33% recycled materials



	Laminate (MB2)	Linoleum (MB4)	Veneer (MB3)	Stained veneer (MB3)	
Melamine, Laminate and Linoleum are with matching ABS edge. Veneer is with matching hardwood edge. Table top thickness: Melamine is 25mm. Laminate, Linoleum and veneer is 24mm.	L42 L43 L50 L55 L310 L420 L110 L600 L500 L210	FL200	V1 V2 V3 V5 V12 V13 V15	LW17 LW25 LW30	
 B6 B51 B52					Linking
Standard frame* with castors with breaks	SEK	SEK	SEK	SEK	
Rectangular	1200x600mm (32AA)	15741	18026	19604	22666
Rectangular	1400x700mm (43AD)	16414	18803	20439	23501
Rectangular	1500x600mm (34AL)	16599	19012	20671	23733
Rectangular	1500x750mm (44AE)	16982	19453	21158	24220
Rectangular	1800x600mm (36AM)	17075	19546	21263	24325
V-shape	1200x600mm (22BO)	16414	18803	20439	23501
V-shape	1400x700mm (73BP)	16901	19360	21054	24116
V-shape	1500x750mm (74BQ)	17075	19546	21263	24325

Price list 2024 - SEK excl. V.A.T. - Version 1.0

### Moveo Training - custom size ranges

Rough, reference information - please verify custom sizes with CS, especially for non-rectangular tabletops

**Rectangle:** width 450-899mm | length 800-2000mm

**V-shape:** 900x450mm - 1600x800mm

20 % rabatt ska dras av på angivna priser.

# Moveo Meeting

By Justus Kolberg & Erik Simonsen

Easy to move thanks to a light frame, Moveo is even more flexible than your calendar. Optimum mobility is ensured by the perfectly designed wheels.

- 10 year warranty
- GreenTag<sup>Cert™</sup>
- FSC certified
- PEFC certified
- Inverted T-leg style
- Flip top table system
- 33% recycled materials

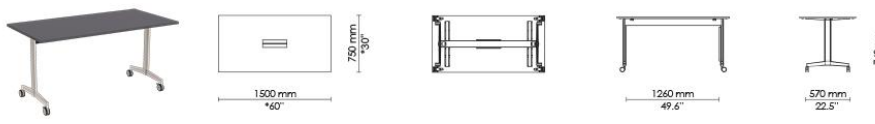
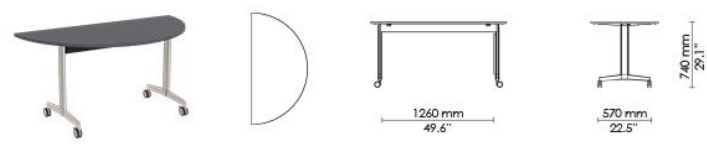
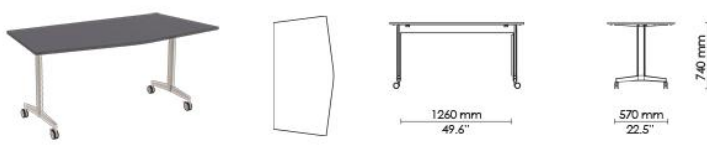

	Laminate (MT2)	Linoleum (MT4)	Veneer (MT3)	Stained veneer (MT3)	
Melamine, Laminate and Linoleum are with matching ABS edge. Veneer is with matching hardwood edge. Table top thickness: Melamine is 25mm. Laminate, Linoleum and veneer is 24mm.	L42 L43 L50 L55 L310 L420 L110 L600 L500 L210	FL200	V1 V2 V3 V5 V12 V13 V15	LW17 LW25 LW30	
 Standard frame* with castors with breaks	SEK	SEK	SEK	SEK	Linking SEK
					
Rectangular	1400x700mm (23AD)	16437	18827	20462	23524
Rectangular	1500x750mm (24AE)	17005	19477	21170	24232
Rectangular	1600x800mm (35AF)	17597	20161	21912	24974
Rectangular	1600x795mm (35SG)	N/A	N/A	N/A	N/A
Rectangular	1800x795mm (36TA)	N/A	N/A	N/A	N/A
Rectangular	1800x900mm (46AJ)	18305	20973	22794	25856
					
Half-round	1500x750mm (12BC)	17597	20161	21912	24974
Half-round	1600x800mm (35BR)	17980	20602	22388	25450
					
V-Shape	1500x750mm (34BQ)	17075	19558	21262	24324
V-Shape	1600x800mm (35BR)	17783	20370	22132	25194

Price list 2024 - SEK excl. V.A.T. - Version 1.0

## Moveo Meeting - custom size ranges

Rough, reference information - please verify custom sizes with CS, especially for non-rectangular tabletops

**Rectangle:** width 600-900mm | length 800-2400mm

**Half-round:** 1300x650mm - 1800x900mm

**V-shape:** 1200x600mm - 1600x800mm

20 % rabatt ska dras av på angivna priser. **HOWE**

# Moveo Conference modular

By Justus Kolberg & Erik Simonsen

Easy to move thanks to a light frame, Moveo is even more flexible than your calendar. Optimum mobility is ensured by the perfectly designed wheels.

- 10 year warranty
- GreenTag<sup>Cert™</sup>
- FSC certified
- PEFC certified
- Inverted T-leg style
- Flip top table system
- 33% recycled materials



	Laminate (MV2)	Linoleum (MV4)	Veneer (MV3)	Stained veneer (MV3)																										
Melamine, Laminate and Linoleum are with matching ABS edge. Veneer is with matching hardwood edge. Table top thickness: Melamine is 25mm. Laminate, Linoleum and veneer is 24mm.	L42 L43 L50 L55 L310 L420 L110 L600 L500 L210	FL200	V1 V2 V3 V5 V12 V13 V15	LW17 LW25 LW30	Linking																									
 B6 B51 B52	SEK	SEK	SEK	SEK		SEK																								
Standard frame* with castors with breaks																														
<table border="1"> <tr> <td>Rectangular</td> <td>1800x1000mm (46AN)</td> <td>34835</td> <td>39881</td> <td>43372</td> <td>49497</td> <td rowspan="4">1833</td> </tr> <tr> <td>Rectangular</td> <td>1800x1200mm (46AO)</td> <td>37190</td> <td>42572</td> <td>46318</td> <td>52443</td> </tr> <tr> <td>Rectangular</td> <td>2200x1000mm (48ER)</td> <td>37596</td> <td>43048</td> <td>46817</td> <td>52942</td> </tr> <tr> <td>Rectangular</td> <td>2200x1200mm (48AR)</td> <td>40670</td> <td>46574</td> <td>50657</td> <td>56782</td> </tr> </table>	Rectangular	1800x1000mm (46AN)	34835	39881	43372	49497	1833	Rectangular	1800x1200mm (46AO)	37190	42572	46318	52443	Rectangular	2200x1000mm (48ER)	37596	43048	46817	52942	Rectangular	2200x1200mm (48AR)	40670	46574	50657	56782					
Rectangular	1800x1000mm (46AN)	34835	39881	43372	49497	1833																								
Rectangular	1800x1200mm (46AO)	37190	42572	46318	52443																									
Rectangular	2200x1000mm (48ER)	37596	43048	46817	52942																									
Rectangular	2200x1200mm (48AR)	40670	46574	50657	56782																									
<table border="1"> <tr> <td>Half-Boat</td> <td>2000x1000mm (86BK)</td> <td>37306</td> <td>42700</td> <td>46434</td> <td>52559</td> <td rowspan="4">916</td> </tr> <tr> <td>Half-Boat</td> <td>2000x1200mm (86BL)</td> <td>40867</td> <td>46795</td> <td>50889</td> <td>57014</td> </tr> <tr> <td>Half-Boat</td> <td>2400x1000mm (89BM)</td> <td>40264</td> <td>46099</td> <td>50123</td> <td>56248</td> </tr> <tr> <td>Half-Boat</td> <td>2400x1200mm (89BN)</td> <td>44672</td> <td>51156</td> <td>55622</td> <td>61747</td> </tr> </table>	Half-Boat	2000x1000mm (86BK)	37306	42700	46434	52559	916	Half-Boat	2000x1200mm (86BL)	40867	46795	50889	57014	Half-Boat	2400x1000mm (89BM)	40264	46099	50123	56248	Half-Boat	2400x1200mm (89BN)	44672	51156	55622	61747					
Half-Boat	2000x1000mm (86BK)	37306	42700	46434	52559	916																								
Half-Boat	2000x1200mm (86BL)	40867	46795	50889	57014																									
Half-Boat	2400x1000mm (89BM)	40264	46099	50123	56248																									
Half-Boat	2400x1200mm (89BN)	44672	51156	55622	61747																									

Price list 2024 - SEK excl. V.A.T. - Version 1.0

## Moveo Conference Modular - custom size ranges

Rough, reference information - please verify custom sizes with CS, especially for non-rectangular tabletops

**Rectangle:** width 900-1200mm | length 800-2200mm

**Half-boat:** width 800-1200mm | length 1000-2400mm

20 % rabatt ska dras av på angivna priser. **HOWE**

# Moveo Conference stand alone

By Justus Kolberg & Erik Simonsen

Easy to move thanks to a light frame, Moveo is even more flexible than your calendar. Optimum mobility is ensured by the perfectly designed wheels.

- 10 year warranty
- GreenTag<sup>Cert™</sup>
- FSC certified
- PEFC certified
- Inverted T-leg style
- Flip top table system
- 33% recycled materials



	Laminate (MR2)	Linoleum (MR4)	Veneer (MR3)	Stained veneer (MR3)		
Melamine, Laminate and Linoleum are with matching ABS edge. Veneer is with matching hardwood edge. Table top thickness: Melamine is 25mm. Laminate, Linoleum and veneer is 24mm.	L42 L43 L50 L55 L310 L420 L110 L600 L500 L210	FL200	V1 V2 V3 V5 V12 V13 V15	LW17 LW25 LW30	Linking	
 B6 B51 B52	SEK	SEK	SEK	SEK		SEK
Standard frame* with castors with breaks						
Rectangular	2000x1000mm (45AJ)	35821	41029	44614	50739	1833
Rectangular	2000x1200mm (45AP)	38222	43767	47584	53709	
Rectangular	2400x1000mm (47AS)	39162	44845	48767	54892	
Rectangular	2400x1200mm (47AK)	41691	47734	51922	58047	
Boat-shape	2000x1000mm (95BG)	37828	43326	47108	53233	1833
Boat-shape	2000x1200mm (45BH)	40415	46295	50344	56469	
Boat-shape	2400x1000mm (97BI)	39997	45808	49822	55947	
Boat-shape	2400x1200mm (47BJ)	43651	50007	54370	60495	

Price list 2024 - SEK excl. V.A.T. - Version 1.0

## Moveo Conference Stand alone - custom size ranges

Rough, reference information - please verify custom sizes with CS, especially for non-rectangular tabletops

**Rectangle:** width 900-1200mm | length 1200-2400mm

**Full boat:** width 800-1200mm | length 1200-2400mm

20 % rabatt ska dras av på angivna priser. **HOWE**

# Moveo modesty panel

By Justus Kolberg & Erik Simonsen

Easy to move thanks to a light frame, Moveo is even more flexible than your calendar. Optimum mobility is ensured by the perfectly designed wheels.

- 10 year warranty
- FSC certified



	Laminate	Linoleum	Veneer
<b>MODESTY PANEL</b>	L42 ●	FL200 ●	V1 ●
	L43 ●		V2 ●
	L50 ●		V3 ●
	L55 ●		V5 ●
	L310 ●		V12 ●
	L420 ●		V13 ●
	L110 ●		V15 ●
	L600 ●		
	L500 ●		
	L210 ●		
	SEK	SEK	SEK
Beam length 975 mm (GCGC)	3399	4675	4802
Beam length 1175 mm (GDGD)	3701	5093	5220
Beam length 1275 mm (GEGE)	4002	5510	5660
Beam length 1375 mm (GFGF)	4002	5510	5660
Beam length 1575 mm (GGGG)	4002	5510	5660
Beam length 1775 mm (GHGH)	4304	5928	6090

Price list 2024 - SEK excl. V.A.T. - Version 1.0

20 % rabatt ska dras av på angivna priser.





# Simpla

By John Bollen

The unique folding system makes Simpla radically different. In addition to a minimalist and elegant silhouette, the two-piece table is flexible and space-saving.

- Lift off top
- Unique flat folding frame
- PEFC certified
- FSC certified
- Up to 8 stacked tables on a transporter
- 5 year warranty

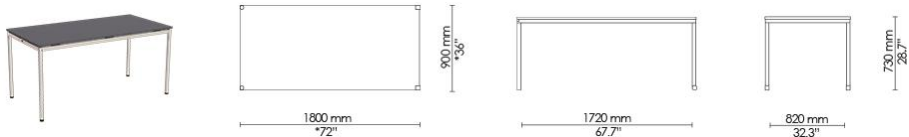

		Laminate (SG2)	Linoleum (SG4)	Veneer (SG3)	Stained Veneer (SG3)	
Melamine, Laminate and Linoleum are standard with matching ABS edge. Veneer is standard with matching hardwood edge. Table top thickness is 18mm Standard frame with glides - optional to get glides and castors. Linking is incl. 2 brackets		L42 ● L43 ● L50 ● L55 ● L310 ● L420 ● L110 ● L600 ● L500 ● L210 ●	FL200 ●	V1 ● V2 ● V3 ● V5 ● V12 ● V13 ● V15 ●	LW17 ● LW25 ● LW30 ●	Linking
		SEK	SEK	SEK	SEK	
Rectangular	1200x600mm (AAAA)	14454	16576	18049	21204	255
Rectangular	1400x700mm (ADAD)	15173	17412	18954	22109	
Rectangular	1500x750mm (AEAE)	15602	17899	19476	22631	
Rectangular	1600x795mm (SGSG)	N/A	N/A	N/A	N/A	
Rectangular	1600x800mm (AFAF)	16217	18583	20230	23385	
Rectangular	1800x900mm (AIAI)	17249	19801	21541	24696	
						
Square	750x750mm (BZBZ)	13955	16008	17423	20578	255
						
Half-round	1400x700mm (BBBB)	16356	18769	20427	23582	255
Half-round	1500x750mm (BCBC)	16727	19186	20880	24035	
Half-round	1600x800mm (BDBD)	17075	19581	21309	24464	

Price list 2024 - SEK excl. V.A.T. - Version 1.0

2 glides and 2 castors

128 SEK

## Simpla - custom size ranges

Rough, reference information - please verify custom sizes with CS, especially for non-rectangular tabletops

**Rectangle:** width 300-1000mm | length 600-2000mm

**square:** 610x610mm - 1200x1200mm

**Half-round:** 1200x600mm - 2000x1000mm

Bar height is NOT available.

Reinforcement applied when the length is 1650mm or more

20 % rabatt ska dras av på angivna priser.

# Simpla

By John Bollen

The unique folding system makes Simpla radically different. In addition to a minimalist and elegant silhouette, the two-piece table is flexible and space-saving.

- Lift off top
- Unique flat folding frame
- PEFC certified
- FSC certified
- 5 year warranty



		Laminate (SG2)	Linoleum (SG4)	Veneer (SG3)	Stained Veneer (SG3)
Melamine, Laminate and Linoleum are standard with matching ABS edge. Veneer is standard with matching hardwood edge. Table top thickness is 18mm Standard frame with glides - optional to get glides and castors. Linking is incl. 2 brackets		L42 L43 L50 L55 L310 L420 L110 L600 L500 L210	FL200	V1 V2 V3 V5 V12 V13 V15	LW17 LW25 LW30
		SEK	SEK	SEK	SEK
Trapezoid	1500x750mm (BEBE)	15846	18177	19789	22944
Trapezoid	1600x800mm (BFBF)	16217	18583	20230	23385
V-Shaped	1500x750mm (BQBQ)	17122	19639	21367	24522
Round	Ø1050mm (BUBU)	16611	19047	20729	23884
Round	Ø1200mm (BVBV)	17841	20462	22272	25427

Price list 2024 - SEK excl. V.A.T. - Version 1.0

2 glides and 2 castors 128 SEK

## Simpla - custom size ranges

Rough, reference information - please verify custom sizes with CS, especially for non-rectangular tabletops

**Round:** Ø850mm - Ø1200mm

Trapezoid, v-shaped - ask CS

Bar height is NOT available.

Reinforcement applied when the length is 1650mm or more

20 % rabatt ska dras av på angivna priser.

# Simpla modesty panel

By John Bollen

The unique folding system makes Simpla radically different. In addition to a minimalist and elegant silhouette, the two-piece table is flexible and space-saving.



Modesty panel		
		Steel
Simpla modesty panel in perforated steel, 250 mm high, with integrated cable tray and hooks to hang it on the Simpla frame.		
Simpla modesty panel in acrylic, 4 mm thick and 250 mm high, made of greenish acrylic plastic, mounted on the hooks.		
Rectangular	1200 mm (DEDEGHY)	3596
Rectangular	1400 mm (DGDGGHY)	3596
Rectangular	1500 mm (DHDHGHY)	4199
Rectangular	1600 mm (DIDIGHY)	4199
Rectangular	1800 mm (DKDKGHY)	4199

Price list 2024 - SEK excl. V.A.T. - Version 1.0

20 % rabatt ska dras av på angivna priser.

# Tempest flip top

By KOMPLOT Design

Detail is everything. It is why the Tempest flips, rolls and unfolds possibilities like no other table system in the world.

- 10 year warranty
- World's leading flip-top table system
- Nesting depth of 130 mm
- 6 tables can be stacked on table transporter
- Elegant elliptical leg-design
- GreenTag<sup>Cert™</sup>
- FSC certified
- ISO 14025 EPD
- **Quick ship - LINK**

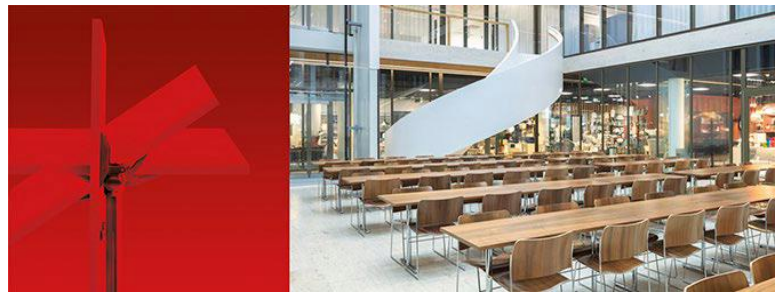

	Laminate (TP2)	Linoleum (TP4)	Veneer (TP3)	Stained veneer (TP3)		
Melamine, laminate and linoleum are with matching ABS edge. Veneer is with matching hardwood edge. Other RAL colours available - ASK HOWE	L42 L43 L50 L55 L310 L420 L110 L600 L500 L210	FL200	● V1 ● V2 ● V3 ● V5 ● V12 ● V13 ● V15	LW17 LW25 LW30	Linking	
Table top thickness: Melamine is 25mm. Laminate, linoleum and veneer is 27mm. Standard frame with glides and castors	SEK	SEK	SEK	SEK		SEK
Rectangular	1200x600mm (02AA)	16170	18316	20207	23200	1833
Rectangular	1200x750mm (02AB)	16738	18966	20915	23908	
Rectangular	1200x800mm (02AC)	16831	19058	21031	24024	
Rectangular	1400x700mm (02AD)	16936	19174	21158	24151	
Rectangular	1500x750mm (02AE)	17504	19824	21866	24859	
Rectangular	1600x795mm (02SG)	N/A	N/A	N/A	N/A	
Rectangular	1600x800mm (02AF)	17875	20253	22341	25334	
Rectangular	1800x750mm (03AG)	18258	20682	22817	25810	
Rectangular	1800x795mm (03TA)	N/A	N/A	N/A	N/A	
Rectangular	1800x800mm (03AH)	18641	21112	23293	26286	
Rectangular	1800x900mm (03AI)	19128	21668	23896	26889	
Rectangular	2000x795mm (03OZ)	N/A	N/A	N/A	N/A	
Rectangular	2000x1000mm (03AJ)	20729	23478	25903	28896	
V-Shape	1500x750mm (02BQ)	19975	22620	24951	27944	N/A

Price list 2024 - SEK excl. V.A.T. - Version 1.0

## Tempest flip I/TT legs - custom size ranges

Rough, reference information - please verify custom sizes with CS, especially for non-rectangular tabletops

**Rectangle:** width 550-1000mm | length 800-2000mm

Bar height NOT available.

20 % rabatt ska dras av på angivna priser.

# Tempest flip top

By KOMPLOT Design

Detail is everything. It is why the Tempest flips, rolls and unfolds possibilities like no other table system in the world.

- 10 year warranty
- World's leading flip-top table system
- Nesting depth of 130 mm
- 6 tables can be stacked on table transporter
- Elegant elliptical leg-design
- GreenTag<sup>Cert™</sup>
- FSC certified
- ISO 14025 EPD



	Laminate (TP2)	Linoleum (TP4)	Veneer (TP3)	Stained veneer (TP3)			
Melamine, laminate and linoleum are with matching ABS edge. Veneer is with matching hardwood edge. Other RAL colours available - ASK HOWE  B1 B6 B7 B9 B10 B30 Table top thickness: Melamine is 25mm. Laminate, linoleum and veneer is 27mm. Standard frame with glides and castors	L42 L43 L50 L55 L310 L420 L110 L600 L500 L210 SEK	FL200 SEK	V1 V2 V3 V5 V12 V13 V15 SEK	LW17 LW25 LW30 SEK	Linking SEK		
	Crescent	1200x750mm (02AW)	22538	25543	28176	31169	1833
	Crescent	1400x700mm (02AY)	23698	26854	29615	32608	
	Crescent	1500x750mm (02AZ)	24615	27886	30763	33756	
	Crescent	1600x800mm (03BA)	26239	29730	32793	35786	
	Trapezoid	1500x750mm (01BE)	18072	20474	22585	25578	N/A
	Trapezoid	1600x800mm (01BF)	18536	20996	23165	26158	
	Half-round	1400x700mm (01BB)	17504	19824	21866	24859	916
	Half-round	1500x750mm (01BC)	17875	20253	22341	25334	
	Half-round	1600x800mm (02BD)	18397	20845	22991	25984	

Price list 2024 - SEK excl. V.A.T. - Version 1.0

## Tempest flip T/T legs - custom size ranges

Rough, reference information - please verify custom sizes with CS, especially for non-rectangular tabletops

**Half-round:** 1200x600mm - 1900x800mm

Crescent, trapezoid - ask CS

Bar height NOT available.

20 % rabatt ska dras av på angivna priser.

# Tempest fold

By KOMPLOT Design

Detail is everything. It is why the Tempest flips, rolls and unfolds possibilities like no other table system in the world.

- 10 year warranty
- Inverted elliptical T-leg style
- Legs: concealed wheel + adjustable glides
- 5 tables can be stacked on table transporter
- FSC certified

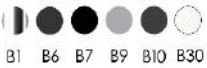
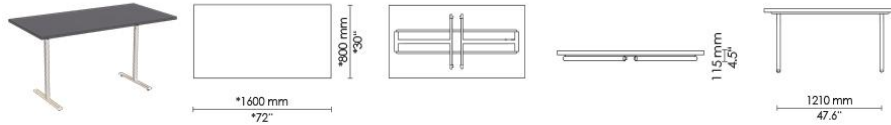
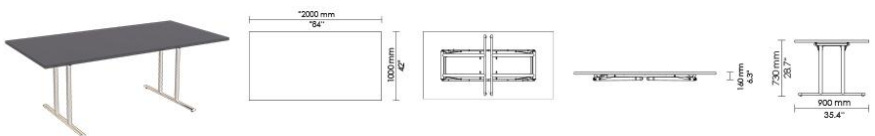

	Laminate (TD2/TA2)	Linoleum (TD4/TA4)	Veneer (TD3/TA3)	Stained veneer (TD3/TA3)		
Melamine, laminate and linoleum are with matching ABS edge. Veneer is with matching hardwood edge. Other RAL colours available - ASK HOWE  Table top thickness: Melamine is 25mm. Laminate, linoleum and veneer is 27mm.	L42 L43 L50 L55 L310 L420 L110 L600 L500 L210 SEK	FL200 SEK	V1 V2 V3 V5 V12 V13 V15 SEK	LW17 LW25 LW30 SEK	Linking	
					SEK	
Rectangular	1200x600mm (04AA)	19488	22086	24360	27701	1833
Rectangular	1200x750mm (04AB)	20161	22852	25207	28548	
Rectangular	1200x800mm (04AC)	20300	23002	25369	28710	
Rectangular	1400x700mm (04AD)	20416	23130	25520	28861	
Rectangular	1500x750mm (05AE)	21089	23896	26355	29696	
Rectangular	1600x795mm (05SG)	N/A	N/A	N/A	N/A	
Rectangular	1600x800mm (05AF)	21553	24429	26935	30276	
Rectangular	1800x750mm (05AG)	22017	24951	27515	N/A	
Rectangular	1800x795mm (05TA)	N/A	N/A	N/A	N/A	
Rectangular	1800x800mm (05AH)	22481	25473	28095	N/A	
Rectangular	1800x900mm (05AI)	23038	26111	28791	32132	
						
Rectangular conf.	2000x1000mm (05AJ)	28002	31726	34997	41122	1833
Rectangular conf.	2400x1200mm (05AK)	30948	35067	38686	44811	

Price list 2024 - SEK excl. V.A.T. - Version 1.0

## Tempest fold T/TT legs - custom size ranges

Rough, reference information - please verify custom sizes with CS, especially for non-rectangular tabletops

**Rectangle:** Width 550-1200mm | length 1005-2400mm  
 Bar height - NOT available.

20 % rabatt ska dras av på angivna priser.

# Tempest fold

By KOMPLOT Design

Detail is everything. It is why the Tempest flips, rolls and unfolds possibilities like no other table system in the world.

- 10 year warranty
- Inverted elliptical T-leg style
- Legs: concealed wheel + adjustable glides
- 5 tables can be stacked on table transporter
- FSC certified

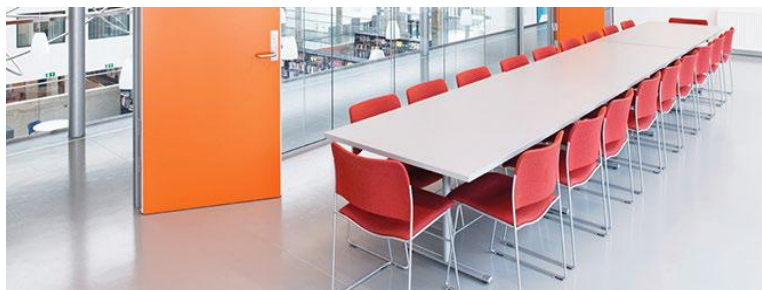

	Laminate (TD2)	Linoleum (TD4)	Veneer (TD3)	Stained veneer (TD3)		
Melamine, laminate and linoleum are with matching ABS edge. Veneer is with matching hardwood edge. Other RAL colours available - ASK HOWE	L42 L43 L50 L55 L310 L420 L110 L600 L500 L210	FL200	V1 V2 V3 V5 V12 V13 V15	LW17 LW25 LW30		
 B1 B6 B7 B9 B10 B30 Table top thickness: Melamine is 25mm. Laminate, linoleum and veneer is 27mm.	SEK	SEK	SEK	SEK	SEK	
Crescent	1200x750mm (04AW)	27156	30786	33953	37294	1833
Crescent	1400x700mm (04AY)	28548	32352	35682	39023	
Crescent	1500x750mm (05AZ)	29673	33628	37085	40426	
Crescent	1600x800mm (05BA)	31633	35855	39544	42885	
Trapezoid	1500x750mm (05BE)	21785	24684	27225	30566	N/A
Trapezoid	1600x800mm (05BF)	22458	25450	28072	31413	

Price list 2024 - SEK excl. V.A.T. - Version 1.0

## Tempest fold T/TT legs - custom size ranges

Rough, reference information - please verify custom sizes with CS, especially for non-rectangular tabletops

Crescent & trapezoid - ask CS

Bar height - NOT available.

20 % rabatt ska dras av på angivna priser.

HOWE

# Tempest fold

By KOMPLOT Design

Detail is everything. It is why the Tempest flips, rolls and unfolds possibilities like no other table system in the world.

- 10 year warranty
- Inverted elliptical T-leg style
- Legs: concealed wheel + adjustable glides
- 5 tables can be stacked on table transporter
- FSC certified



	Laminate (TD2)	Linoleum (TD4)	Veneer (TD3)	Stained veneer (TD3)			
<p>Melamine, laminate and linoleum are with matching ABS edge. Veneer is with matching hardwood edge. Other RAL colours available - ASK HOWE</p> <p>Table top thickness: Melamine is 25mm. Laminate, linoleum and veneer is 27mm.</p>	L42 L43 L50 L55 L310 L420 L110 L600 L500 L210 SEK	FL200 SEK	V1 V2 V3 V5 V12 V13 V15 SEK	LW17 LW25 LW30 SEK	Linking SEK		
	V-Shape	1500x750mm (05BQ)	24082	27283	30090	33431	N/A
	Half-round	1400x700mm (04BB)	21089	23896	26355	29696	916
	Half-round	1500x750mm (05BC)	21553	24429	26935	30276	
	Half-round	1600x800mm (05BD)	22168	25125	27712	31053	

Price list 2024 - SEK excl. V.A.T. - Version 1.0

## Tempest fold T/TI legs- custom size ranges

Rough, reference information - please verify custom sizes with CS, especially for non-rectangular tabletops

**Half-round:** 1400x700mm – 2400x1200mm

V-shape - ask CS

Bar height - NOT available.

20 % rabatt ska dras av på angivna priser.



# Tempest fix

By KOMPLOT Design

Detail is everything. It is why the Tempest flips, rolls and unfolds possibilities like no other table system in the world.

- 10 year warranty
- Inverted elliptical T-leg style
- Legs: concealed wheel + adjustable glides
- GreenTag<sup>CertTM</sup>
- FSC certified
- ISO 14025 EPD



	Laminate (T12)	Linoleum (T14)	Veneer (T13)	Stained veneer (T13)		
Melamine, laminate and linoleum are with matching ABS edge. Veneer is with matching hardwood edge. Other RAL colours available - ASK HOWE	L42 L43 L50 L55 L310 L420 L110 L600 L500 L210	FL200	V1 V2 V3 V5 V12 V13 V15	LW17 LW25 LW30		
<p>B1 B6 B7 B9 B10 B30</p> <p>Table top thickness: Melamine is 25mm. Laminate, linoleum and veneer is 27mm.</p>	SEK	SEK	SEK	SEK	Linking SEK	
Rectangular	1200x600mm (06AA)	14442	16368	18050	21043	1833
Rectangular	1200x750mm (06AB)	14964	16960	18700	21693	
Rectangular	1200x800mm (06AC)	15034	17029	18781	21774	
Rectangular	1400x700mm (06AD)	15138	17145	18908	21901	
Rectangular	1500x750mm (06AE)	15648	17737	19558	22551	
Rectangular	1600x795mm (06SG)	N/A	N/A	N/A	N/A	
Rectangular	1600x800mm (06AF)	15985	18108	19976	22969	
Rectangular	1800x750mm (06AG)	16310	18479	20382	23375	
Rectangular	1800x795mm (06TA)	N/A	N/A	N/A	N/A	
Rectangular	1800x800mm (06AH)	16658	18874	20811	23804	
Rectangular	1800x900mm (06AI)	17087	19361	21356	24349	
Half-round	1400x700mm (06BB)	15648	17737	19558	22551	916
Half-round	1500x750mm (06BC)	15985	18108	19976	22969	
Half-round	1600x800mm (06BD)	16426	18618	20532	23525	

Price list 2024 - SEK excl. V.A.T. - Version 1.0

## Tempest fix T/TT legs- custom size ranges

Rough, reference information - please verify custom sizes with CS, especially for non-rectangular tabletops

**Rectangle:** width 550-1400mm | length 800-2400mm \*Note depending on finish and overall size e.g. width 1400 works with max 2000 length

**Half-round:** 1200x600mm – 2400x1200mm

Bar height - NOT available.

20 % rabatt ska dras av på angivna priser.

# Tempest fix

By KOMPLOT Design

Detail is everything. It is why the Tempest flips, rolls and unfolds possibilities like no other table system in the world.

- 10 year warranty
- Inverted elliptical T-leg style
- Legs: concealed wheel + adjustable glides
- GreenTag<sup>Cert™</sup>
- FSC certified
- ISO 14025 EPD



	Laminate (T12)	Linoleum (T14)	Veneer (T13)	Stained veneer (T13)			
Melamine, laminate and linoleum are with matching ABS edge. Veneer is with matching hardwood edge. Other RAL colours available - ASK HOWE	L42 L43 L50 L55 L310 L420 L110 L600 L500 L210	FL200	V1 V2 V3 V5 V12 V13 V15	LW17 LW25 LW30			
<p>B1 B6 B7 B9 B10 B30</p> <p>Table top thickness: Melamine is 25mm. Laminate, linoleum and veneer is 27mm.</p>	SEK	SEK	SEK	SEK	Linking SEK		
	Crescent	1200x750mm (06AW)	20138	22829	25172	28165	1833
Crescent	1400x700mm (06AY)	21158	23978	26448	29441		
Crescent	1500x750mm (06AZ)	21970	24906	27458	30451		
Crescent	1600x800mm (06BA)	23444	26564	29302	32295		
	Trapezoid	1500x750mm (06BE)	16147	18305	20184	23177	N/A
Trapezoid	1600x800mm (06BF)	16565	18781	20706	23699		
	V-Shape	1500x750mm (06BQ)	17829	20208	22284	25277	N/A

Price list 2024 - SEK excl. V.A.T. - Version 1.0

### Tempest fix T/TT legs- custom size ranges

Rough, reference information - please verify custom sizes with CS, especially for non-rectangular tabletops

Crescent, trapezoid, v-shape - ask CS

Bar height - NOT available.

20 % rabatt ska dras av på angivna priser.

# Tempest modesty panel

By KOMPLOT Design

Detail is everything. It is why the Tempest flips, rolls and unfolds possibilities like no other table system in the world.

- 10 year warranty
- FSC certified

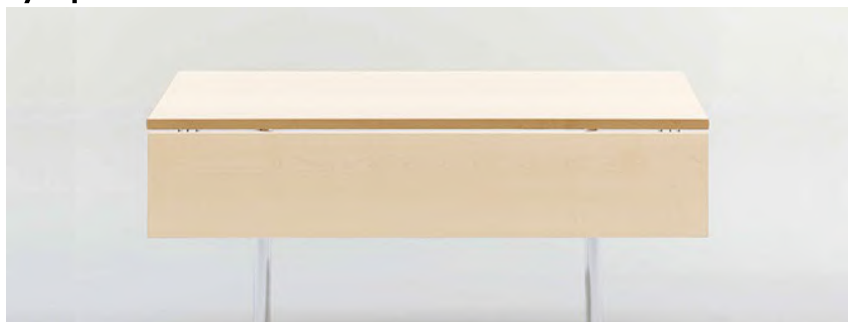

		Laminate	Linoleum	Veneer		
		9 mm	9 mm	9 mm		
<b>MODESTY PANEL - Hook</b>						
Rectangular modesty panel, on hooks, panel height 250 mm. Suitabe for rectangular flip-top or fixed tables. *standard colour, same as tabletop		L42	FL200	V1		
		L43		V2		
		L50		V3		
		L55		V5		
		L310		V12		
		L420		V13		
		L110		V15		
		L600				
		L500				
		L210				
			SEK	SEK	SEK	
		Rectangular	700 mm (FMFM)	3097	4257	4373
Rectangular	750 mm (FNFN)	3097	4257	4373		
Rectangular	800 mm (DADA)	3097	4257	4373		
Rectangular	1200 mm (DEDE)	3399	4675	4791		
Rectangular	1400 mm (DGDG)	3700	5092	5231		
Rectangular	1500 mm (DHDH)	4002	5510	5661		
Rectangular	1600 mm (DIDI)	4002	5510	5661		
Rectangular	1800 mm (DKDK)	4002	5510	5661		
<b>MODESTY PANEL - Demountable</b>						
Rectangular modesty panel, on hooks, panel height 250 mm. Suitabe for rectangular flip-top or fixed tables. *standard colour, same as tabletop		Laminate	Linoleum	Veneer		
		20 mm	20 mm	20 mm		
		Rectangular	700 mm (FMFM)	3352	4199	4269
		Rectangular	750 mm (FNFN)	3352	4199	4269
		Rectangular	800 mm (DADA)	3352	4199	4269
		Rectangular	1200 mm (DEDE)	3688	4617	4687
		Rectangular	1400 mm (DGDG)	3804	4767	4861
		Rectangular	1500 mm (DHDH)	3920	4918	5011
		Rectangular	1600 mm (DIDI)	3920	4918	5011
		Rectangular	1800 mm (DKDK)	4060	5069	5162

Price list 2024 - SEK excl. V.A.T. - Version 1.0

20 % rabatt ska dras av på angivna priser.

















# Tutor

By John Bollen

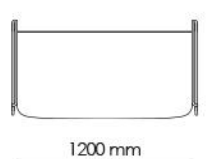
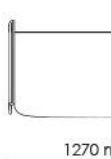
This stackable table pays tribute to the iconic 40/4 chair, and in the process, becomes an icon itself.

- Up to 30 tables can be stacked on dolly
- Up to 10 tables can be stacked on floor
- Use in education and training establishments
- 5 year warranty
- **Quick ship - LINK**

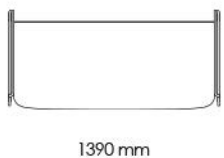
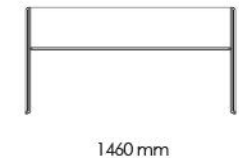

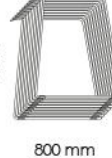
		Compact Laminate (OFA)			
Table top thickness is 6 mm bendable compact laminate. Other compact laminate colours: ask HOWE Other RAL colours - ask HOWE		F300 	F200 	With felt glides (F)	
 B1 B7 B9 B10 B30		SEK		SEK	
  600 mm 23.6"		 670 mm 26.4"	 665 mm 26.2"	 720 mm 28.3"	 800 mm 31.5"
Single table	600 mm (AA)		6948		7110
  1200 mm 47.2"		 1270 mm 50"		 720 mm 28.3"	 905 mm 35.6"
Double table	1200 mm (BA)		10173		10335
*Suitable for side chairs					
  1390 mm 54.7"		 1460 mm 57.5"		 720 mm 28.3"	 905 mm 35.6"
*Double table	1390 mm (CA)		12307		12469
*Suitable for armchairs and swivel chairs					

Price list 2024 - SEK excl. V.A.T. - Version 1.0

Net price: RAL K5 colours for frame - see notes

## Tutor - custom size ranges

Rough, reference information - please verify custom sizes with CS  
600-1390mm

20 % rabatt ska dras av på angivna priser.







# Usu

By HOWE in-house design team

Usu is a study of simplicity in both form and function. The intuitive folding mechanism and transporter, with room for ten rectangular and square tables, make Usu easy to move.

- 5 year warranty
- Up to 10 rectangular and square tables stacked on a transporter
- Stylish round 4-leg design
- FSC certified
- Design for disassembly

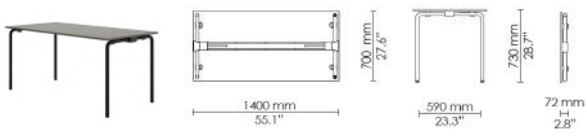

Laminate is standard with matching ABS edge. Table top thickness is 18mm. Standard frame with 2 glides and 2 castors. Linking is incl. 2 brackets		Laminate (UF2)
 <p>*Due to the technological process, the black may slightly differ in terms of its gloss.</p>		L310  L420  L110  L600  L500  L210 
		SEK
Rectangular	1200x600mm (AAAA)	9442
Rectangular	1400x700mm (ADAD)	10393
Rectangular	1600x800mm (AFAF)	10753
Rectangular	1800x800mm (AHAH)	11020
Rectangular	1800x900mm (AIAI)	12064
Square	800x800mm (CACA)	9442
Round	Ø1200mm (BVBV)	12191

Price list 2024 - SEK excl. V.A.T. - Version 1.0

Linking	93	SEK
** Chrome base	719	SEK

## Usu - custom size ranges

Rough, reference information - please verify custom sizes with CS, especially for non-rectangular tabletops

**Rectangle:** width 500-900mm | length 800-1800mm

**Round:** Ø1100- Ø1200mm

Square - ask CS

20 % rabatt ska dras av på angivna priser.









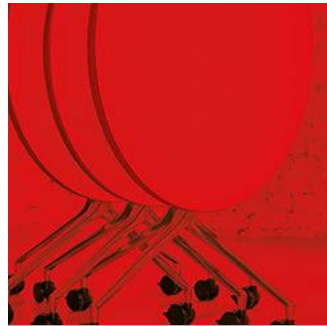

# AS400

By Andreas Störiko

The AS series is highly inspired and highly functional. Combining elegance and utility with true mobility, the family of nesting chairs and tables leaves room for all imaginable purposes.

- 10 year warranty
- Café height tables
- Unbelievably easy to manoeuvre
- Intuitive flip-top mechanism
- Special handle allows to lift the AS tables
- Smart elastic cord firmly joins concave tables
- Rubber bumper protects tables from scratches
- An infinite number of tables can then be nested together



		Laminate (AB2)	Linoleum (AB4)	Veneer (AB3)
Laminates are with matching ABS edge. Linoleum and veneer are with non-matching, transparent lacquer. Other RAL colours available - ASK HOWE Standard base colours: B6 B7 B31 B51	L42 L43 L310 L420 L110 L600 L500 L210	● ● ● ● ● ● ● ●	FL200 ●	V2 ● V3 ●
		SEK	SEK	SEK
	 640 mm 25.2"	 745 mm 29.3"	 735 mm 29"	 160 mm 6.3"
Square	640 x 640 mm (tiny pre-drills in the top; possibility to order linking later)	10034	13700	14883
Square with link	640 x 640 mm	10660	14326	15509
	 830 mm 32.7"	 745 mm 29.3"	 735 mm 29"	 160 mm 6.3"
Round	Ø830mm	10034	13700	14883
Concave with link	Ø830mm	10858	14593	15834

Price list 2024 - SEK excl. V.A.T. - Version 1.0

Transparent lacquer on plywood core for laminate or nano-laminate	2332 SEK
Soft lane castors	139 SEK

20 % rabatt ska dras av på angivna priser.

# AS500

By Andreas Störiko

The AS series is highly inspired and highly functional. Combining elegance and utility with true mobility, the family of nesting chairs and tables leaves room for all imaginable purposes.

- 10 year warranty
- Bar height tables
- Unbelievably easy to manoeuvre
- Intuitive flip-top mechanism
- Special handle allows to lift the AS tables
- Smart elastic cord firmly joins concave tables
- Rubber bumper protects tables from scratches
- An infinite number of tables can then be nested together



	Laminate (AD2)	Linoleum (AD4)	Veneer (AD3)	
Laminate are with matching ABS edge. Linoleum and veneer are with non-matching, transparent lacquer. Other RAL colours available - ASK HOWE Standard base colours: B6 B7 B31 B51	L42 L43 L310 L420 L110 L600 L500 L210	FL200	V2 V3	
	SEK	SEK	SEK	
Square (tiny pre-drills in the top; possibility to order linking later)	600 x 600 mm	10753	14523	15776
Square with link	600 x 600 mm	11379	15149	16402
Round	Ø700 mm	10753	14523	15776

Price list 2024 - SEK excl. V.A.T. - Version 1.0

Transparent lacquer on plywood core for laminate or nano-laminate	2332 SEK
---	----------

Soft lane castors	139 SEK
-------------------	---------

20 % rabatt ska dras av på angivna priser. **HOWE**

# Accessories

## Tables' transporters

HOWE combines simplicity and functionality with a focus on timeless originality. In every moving detail. This is why our furniture stacks, folds, rolls and creates flexible solutions like no other designs in the world.



<b>Tempest Flip-top</b>		No.	Per Piece	
Capacity up to 5 tables standing up (flipped position). Dimensions: 960 mm high, 2000 mm long and 915 mm wide. MDF platform, metal powdercoated in B10 Howe grey.				
Transporter	Tempest	TFTS0110	30160	SEK
<b>Tempest Fold</b>			Per Piece	
Capacity: up to 10 pcs Stacks on table edge, secured with straps. Top against top - base against base. Colour B10 Howe grey. Dimensions: 1131 mm high x 2010 mm long x 562 mm wide Suitable for length 1200-1800 mm and width 600-900 mm.				
A-kit big	Tempest	UNTAS000110	14500	SEK
<b>Only USU</b>			Per Piece	
Capacity: up to 10 pcs Stacks on table edge, secured with strap. Colour: black Height: 1125 mm, length: 1155 mm, depth: 450 mm. The dimensions are without tables on the transporter. Suitable for rectangular and square tables 800-1800 mm long and 500-900 mm wide				
Usu dolly	Usu	780TR001	13920	SEK
<b>Tempest Fold</b>			Per Piece	
Capacity w/rectangular tables: up to 5 pcs Capacity w/ all other shapes: up to 5 pcs Stacks on table edge, secured with straps. Top against top - base against base. Colour B10 Howe grey. Dimensions: 1255 mm high x 2010 mm long x 775 mm wide. Suitable for length 2000-2400 mm and width 1000-1200 mm (when rectangular).				
L-kit	Tempest	UNTLS000310	18792	SEK

Price list 2024 - SEK excl. V.A.T. - Version 1.0

20 % rabatt ska dras av på angivna priser.





# Accessories

## Tables' transporters cont.

HOWE combines simplicity and functionality with a focus on timeless originality. In every moving detail. This is why our furniture stacks, folds, rolls and creates flexible solutions like no other designs in the world.













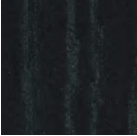
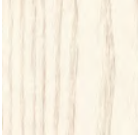

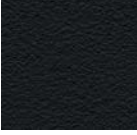

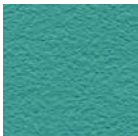

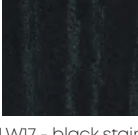

<b>Simpla</b>		No.	Per Piece	
Capacity up to 8 tables. Colour B10 Howe grey. Dimensions: height 1895, depth 840, adjustable width Suitable for rectangular tables: length 1000-1800 and width up to 900 mm. For other shapes and sizes, please ask HOWE.				
Transporter	Simpla	STRA1000000 010	24360	
<b>Tutor single size</b>			Per Piece	
Capacity up to 30 tables. Suitable for single size Tutor tables. Colour B10 Howe grey.				
Transporter	Tutor	OLYS0600SF1 0	14500	
<b>Tutor double size</b>			Per Piece	
Capacity up to 30 tables. Suitable for double size Tutor tables. Colour B10 Howe grey.				
Transporter	Tutor	OLYS1200SS1 0	17400	

Price list 2024 - SEK excl. V.A.T. - Version 1.0

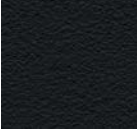
20 % rabatt ska dras av på angivna priser.

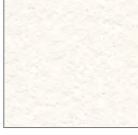
# Finish selection - Chairs

40/4 Seats / backs Natural wood veneers								
	V1 - maple	V2 - beech	V3 - oak	V5 - cherry	V12 - ash EMEA ONLY	V13 - birch EMEA ONLY	V15 - walnut	
40/4 Seats / backs Stains				All RAL colours available based upon customer sample				
	LW17 - black	LW30 - white	Any RAL					
40/4 Seats / backs Polyamide								
	PA200 - black	PA100 - Howe grey	PA300 - coconut	PA110 - Ayers Rock red	PA260 - marine blue			
								
	PA360 - olive green	PA320 - mandarin	PA250 - blue eyes	PA370 - mint turquoise	PA380 - aubergine			
40/4 Seats / backs Metal					All RAL colours available based upon customer sample			
	ME200 - black	ME300 - white	ME110 - red EMEA ONLY	Any RAL				
40/4 WOOD FRAME Seats / backs Natural wood veneers / stains								
	V2 - beech	V3 - oak	LW17 - black stain	LW25 - walnut stain				
SixE Shells Polypropolyne								
	PP310 - wheat	PP270 - ocean	PP120 - red ochre	PP340 - fawn	PP350 - lichen			
			→ HOWE GREY SHELL AVAILABLE AS 100% RECYCLED					
	PP200 - black	PP100 - Howe grey			PP300 - chalk	PP110 - Ayers Rock red	PP250 - blue eyes	PP360 - olive green

**20 % rabatt ska dras av på angivna priser.**

MN1  
Backs  
Natural wood  
veneers / stains



V3 - oak

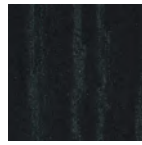

LW17 - black stain

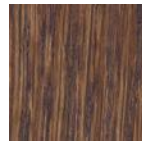

LW25 - walnut stain

40/4  
SIXE  
Frames  
Steel



B1 - chrome

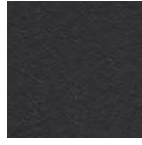

B6 - satin black



B7 - black

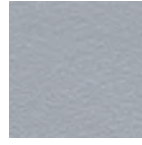

B9 - alu grey



B10 - Howe grey



B30 - white



Any RAL

All RAL colours  
available based  
upon customer  
sample

SIXE  
ONLY

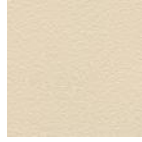

Wheat



Ocean

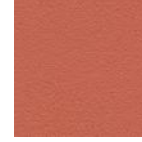

Red ochre



Fawn



Lichen

SIXE SWIVEL  
SIXE LEARN  
Base  
Polyamide



PA100 - Howe grey

SIXE SWIVEL  
SIXE LEARN\*  
Swing arm\*  
Gas lift



B10 - Howe grey

MN1  
Bases



B1 - chrome



B7 - black



B51 - polished alu

AS100  
Bases / seat frames

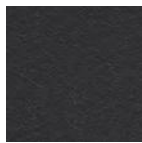

B6 - satin black



B7 - black

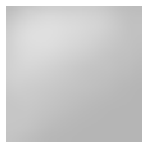

B51 - polished alu

# CHAIRS



20 % rabatt ska dras av på angivna priser.

## Finish selection - Tables EMEA

AS TABLES  
MOVEO  
SIMPLA  
TEMPEST

Tops  
Natural wood  
veneers / Stains



V1 - maple



V2 - beech



V3 - oak



V5 - cherry

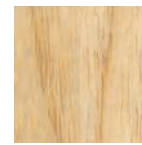

V12 - ash



V13 - birch

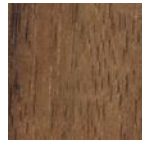

V15 - walnut

AS tables standard:  
V2 beech, V3 oak ONLY

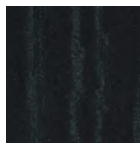

LW17 - black stain

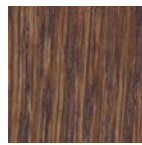

LW25 - walnut stain



LW30 - white stain



Any RAL

All RAL colours available  
based upon customer sample

AS TABLES  
MOVEO  
SIMPLA  
TEMPEST

Tops  
Wood grain  
laminates



L42 - beech

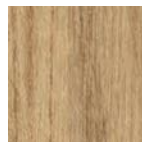

L43 - oak

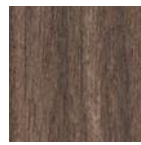

L55 - walnut

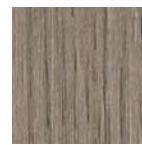

L50 - grey oak

AS tables standard:  
L42 beech, L43 oak ONLY

AS TABLES  
MOVEO  
SIMPLA  
TEMPEST  
USU

Tops  
Coloured  
laminates



L310 - white



L420 - grey



L110 - Howe grey



L210 - black

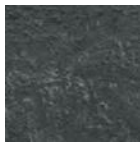

L500 - metal slate



L600 - stone grey



Any coloured  
laminates\*

\*Any coloured laminates  
does not apply to Usu

AS TABLES  
MOVEO  
SIMPLA  
TEMPEST

Tops  
Coloured  
nano laminates



NL350 - eggshell white



NL450 - warm grey



NL200 - black



**20 % rabatt ska dras av på angivna priser.**

# TABLES EMEA

MOVEO  
SIMPLA  
TEMPEST  
USU  
Tops  
Melamines



M310 - white

TUTOR  
Tops  
Bendable  
compact  
laminates



F300 - white

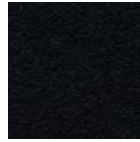

F200 - black



Any bendable  
compact laminate

AS TABLES  
MOVEO  
SIMPLA  
TEMPEST  
Tops  
Linoleums

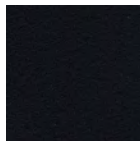

FL200 - black



SIMPLA  
TUTOR  
Bases  
Steel



B1 - chrome

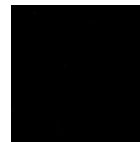

B7 - black

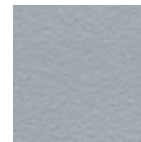

B9 - alu grey

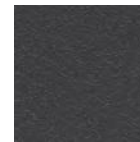

B10 - Howe grey



B30 - white

TEMPEST  
Bases  
Steel

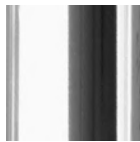

B1 - chrome



B6 - satin black

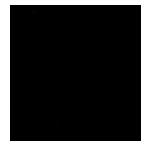

B7 - black

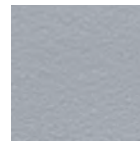

B9 - alu grey



B10 - Howe grey



B30 - white

USU  
Bases  
Steel



B1 - chrome

MOVEO  
Bases  
Aluminum

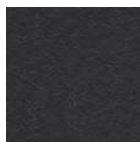

B6 - satin black



B51 - polished alu



B52 - anodized alu

AS TABLES  
Bases

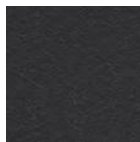

B6 - satin black



B7 - black



B31 satin white  
- columns only

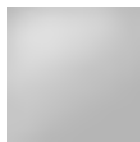

B51 - polished alu  
- bases only

**20 % rabatt ska dras av på angivna priser.**