

& Tradition

2023

STATLIGT RAMAVTAL FÖR

Möbler och inredning

Delområde: Möte och paus

DNR 23.3-5834-2022-009

Produktlista Nr: 1

22% RABATT SKA DRAS AV
PÅ ANGIVNA PRISER



SENAB

Developing interiors

Vi hjälper dig att hitta rätt

Med olika utseende på prislistor från olika möbeltillverkare förstår vi att det kan vara tidskrävande att navigera i denna information. Vi på Senab är jobbar dagligen i dessa, så låt oss göra sökandet enkelt och bekvämt för dig, och hjälpa dig till rätt beslut. Här hittar du din kontaktperson på våra respektive kontor.

STOCKHOLM

Peter Almgren
076-533 50 43
peter.almgren@senab.com
Regeringsgatan 66
111 39 Stockholm

HÄLSINGLAND

Frida Engberg
076-501 10 91
frida.engberg@senab.com
Karlsvägen 2
828 25 Edsbyn

SUNDSVALL

Jonas Westerlund
076-502 02 04
jonas.westerlund@senab.com
Storgatan 4
852 30 Sundsvall

GÖTEBORG

Henrik Ericsson
073-044 10 91
henrik.ericsson@senab.com
Fiskhamngatan 6C
414 58 Göteborg

GÄVLE/DALARNA

Cecilia Sjöblom
076-501 10 93
cecilia.sjoblom@senab.com
Nygatan 28
803 11 Gävle

UMEÅ

Patrik Karlsson
070-654 0066
patrik.karlsson@senab.com
Storgatan 41
903 25 Umeå

MALMÖ

Magdalena Andersson
076-535 75 87
magdalena.andersson@senab.com
Fersens väg 3
211 42 Malmö

JÖNKÖPING

Pia Heldt
076-533 51 57
pia.heldt@senab.com
Västra Storgatan 19A
553 15 Jönköping

UPPSALA

Linnéa Hempel
076-195 39 86
linnea.hempel@senab.com
Stationsgatan 32 C
753 40 Uppsala

22% RABATT SKA DRAS AV
PÅ ANGIVNA PRISER

SENAB

Developing interiors

&Tradition The Collection 2024

KAMMARKOLLEGIET AVROPA 2024

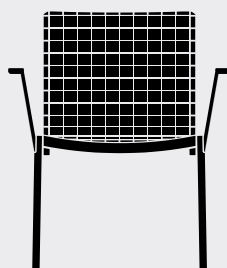
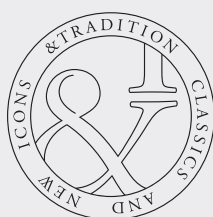
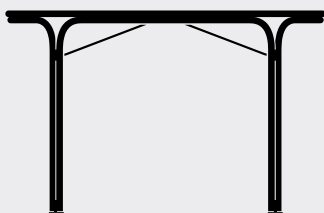



























































































Price list 2024 – Valid from February 1st
Currency: SEK

SENAB

































































22% RABATT SKA DRAS AV PÅ ANGIHVNA PRISER

Index

Chairs and Lounge



































Catch p. 15-16	JH1 	JH2 	JH15 	JH13 	JH14 	
Catch p. 17	JH16 	JH17 				
Elefy p. 18-20	JH28 	JH29 	JH30 	JH31 		
Elefy p. 22-25	JH32 	JH33 	JH34 	JH35 		
Elefy p. 26-27	JH36 	JH37 				
In Between p. 28-31	SK1 	SK2 	SK7 	SK8 	SK9 	SK10 
Pavilion p. 32-38	AV1 	AV2 	AV3 	AV4 	AV12 	AV13 
Pavilion p. 39-41	AV5 	AV6 	AV11 			
Pavilion p. 42-47	AV7 	AV8 	AV14 	AV9 	AV10 	AV15 
Rely p. 48-52	HW6 	HW7 	HW8 	HW9 	HW10 	
Rely p. 53-63	HW11 	HW12 	HW13 	HW14 	HW15 	
	HW16 	HW17 	HW18 	HW19 	HW20 	
Rely p. 63-67	HW21 	HW22 	HW23 	HW24 	HW25 	
Rely p. 68-69	HW26 	HW27 				
Rely p. 70-74	HW65 	HW66 	HW67 	HW68 	HW69 	
Rely p. 75-79	HW28 	HW29 	HW30 	HW31 	HW32 	
Rely p. 80-84	HW33 	HW34 	HW35 	HW36 	HW37 	
Rely p. 85-94	HW38 	HW39 	HW40 	HW41 	HW42 	
	HW43 	HW44 	HW45 	HW46 	HW47 	
Rely p. 95-99	HW48 	HW49 	HW50 	HW51 	HW52 	

Index

Rely p. 100-104	HW53 	HW54 	HW55 	HW56 	HW57 	
Rely p. 105-112	HW71 	HW72 	HW73 	HW74 	HW75 	
Rely p. 110-114	HW76 	HW77 	HW78 	HW79 	HW80 	
Rely Counter stool p. 115-119	HW81 	HW82 	HW83 	HW84 	HW85 	
Rely Bar stool p. 120-124	HW86 	HW87 	HW88 	HW89 	HW90 	
Rely Counter chair p. 125-129	HW91 	HW92 	HW93 	HW94 	HW95 	
Rely Bar chair p. 130-134	HW96 	HW97 	HW98 	HW99 	HW100 	
Rely Lounge chair p. 135-139	HW101 	HW102 	HW103 	HW104 	HW105 	
Rely Seat Pad p. 140-143	Seat pad 	Armchair seat pad 	Stool seat pad 			
Betty p. 143-146	TK1 	TK2 	TK3 	TK9 NEW 	TK10 NEW 	TK11 NEW 
Betty p. 147-148	TK4 	TK5 	TK7 	TK8 		
Allwood p. 151	AV35 NEW 	AV35 NEW 				
Wire Stool & Seat Pad p. 152	VP11 NEW 	Seat pad NEW 				
Boomerang p. 151-152	HM1 	HM2 				
X p. 153	HM10 					
AX p. 154	HM11 NEW 					
Drawn p. 155	HM3 	HM4 	Seat pad 			





















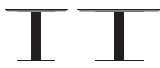





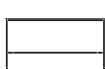
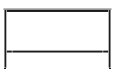

Index

Lounge and Sofas

Little Petra & Pouf p. 156-161	VB1 	VB2 	VB3 NEW 	ATD1 		
Wulff & Pouf p. 162-164	ATD2 	ATD3 				
Margas p. 165-167	LC1 	LC2 	LC3 			
Loafer p. 168-171	SC24 	SC23 	SC25 	SC26 		
Inland p. 172-175	AV21 	AV22 	AV23 	AV32 		
Mayor p. 176-177	AJ5 	AJ6 				
Cloud p. 178-180	LN1 	LN2 	LN3.2 			
Cloud p. 181-183	LN5 	LN6 	LN7 			
Develius p. 184-195	EV1- EV7 	EV1J- EV2K 	EV8A- EV8K NEW 			
Isole p. 197-198	NN1A- NN1G 					
Fly p. 199-204	SC10 	SC1 	SC2 	SC3 	SC12 	SC9 

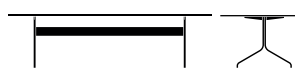
Index

Tables

Fly p. 205-206	SC4 	SC5 	SC11 
Sett p. 207	LN11 NEW 	LN12 NEW 	LN13 NEW 
In Between p. 208-209	SK13 SK14 SK15 	SK23 SK24 	
In Between p. 210-212	SK3 SK4 	SK5 	SK6 
In Between p. 213-218	SK11 SK12 	SK16- SK21 	SK16 SK17 SK21 SK22 
Patch p. 219-220	HW1 	HW2 	
Drip p. 221-223	HW58 	HW59 	HW60 
Drip p. 224-233	HW61 HW62 	HW63 HW64 	HW111 HW112 
Pavilion p. 234	AV16 	AV17 	
Pavilion p. 235	AV18 	AV19 	AV24 
Lato p. 238	LN8 	LN9 	
Rotate p. 240	SC73 		
Alima p. 241	NDS1 		

Halten
p. 246

SH9
NEW



Amore
p. 288

SC49



SC50



SC56



Sillon
p. 289

SH4-
SH7



Catch JH1, JH2 & JH15

Jaime Hayon

2013 & 2017

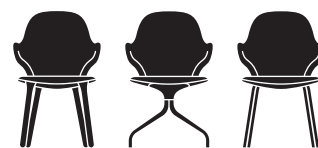

Price group	Upholstery	Model	Base	Lead time	Weight	PRICE EX. VAT (SEK)	PRICE INC. VAT (SEK)
Fabric gr. 1	Hot Madison, Remix, Re-Wool	JH1	Solid Oak	6-8 weeks	8.50 kg	7.756	9.695
		JH2	Swivel	6-8 weeks	9.50 kg	9.068	11.335
		JH15	Tube	6-8 weeks	8.50 kg	7.756	9.695
Fabric gr. 2	Canvas, Barnum, Fiord, Ritz	JH1	Solid Oak	6-8 weeks	8.50 kg	8.352	10.440
		JH2	Swivel	6-8 weeks	9.50 kg	9.664	12.080
		JH15	Tube	6-8 weeks	8.50 kg	8.352	10.440
Fabric gr. 3	Clay, Hallingdal, Steelcut Quartet, Steelcut Trio	JH1	Solid Oak	6-8 weeks	8.50 kg	8.592	10.740
		JH2	Swivel	6-8 weeks	9.50 kg	9.904	12.380
		JH15	Tube	6-8 weeks	8.50 kg	8.592	10.740
Fabric gr. 4	Acca, Cifrado, Ecriture, Moss, Uniform Melange, Vidar	JH1	Solid Oak	6-8 weeks	8.50 kg	9.548	11.935
		JH2	Swivel	6-8 weeks	9.50 kg	10.860	13.575
		JH15	Tube	6-8 weeks	8.50 kg	9.548	11.935
Fabric gr. 5	Karakorum, Sisu	JH1	Solid Oak	6-8 weeks	8.50 kg	11.100	13.875
		JH2	Swivel	6-8 weeks	9.50 kg	12.412	15.515
		JH15	Tube	6-8 weeks	8.50 kg	11.100	13.875
Fabric gr. 6	Fuse, Gentle	JH1	Solid Oak	6-8 weeks	8.50 kg	12.292	15.365
		JH2	Swivel	6-8 weeks	9.50 kg	13.604	17.005
		JH15	Tube	6-8 weeks	8.50 kg	12.292	15.365
Leather	Tailor Semi-aniline leather	JH1	Solid Oak	6-8 weeks	8.50 kg	11.936	14.920
		JH2	Swivel	6-8 weeks	9.50 kg	13.248	16.560
		JH15	Tube	6-8 weeks	8.50 kg	11.936	14.920
Leather	Noble Aniline leather	JH1	Solid Oak	6-8 weeks	8.50 kg	14.084	17.605
		JH2	Swivel	6-8 weeks	9.50 kg	15.396	19.245
		JH15	Tube	6-8 weeks	8.50 kg	14.084	17.605
Leather	Elmosoft Semi-aniline leather	JH1	Solid Oak	6-8 weeks	8.50 kg	15.876	19.845
		JH2	Swivel	6-8 weeks	9.50 kg	17.188	21.485
		JH15	Tube	6-8 weeks	8.50 kg	15.876	19.845
Fabric COM	COM Fabric	JH1	Solid Oak	6-8 weeks	8.50 kg	7.756	9.695
		JH2	Swivel	6-8 weeks	9.50 kg	9.068	11.335
		JH15	Tube	6-8 weeks	8.50 kg	7.756	9.695

JH1: Felt gliders installed as standard.
JH2: Plastic gliders installed as standard.
JH15: Plastic gliders installed as standard. Felt gliders available upon request.

Base	Finish
Solid Oak	Oiled Oak, Smoked Oiled Oak, Water Based Black Lacquered Oak
Swivel	Powder Coated Black, Polished Aluminium
Tube	Powder Coated Black

Material: Moulded PU foam and HR foam.

Fabric usage: 1.8 meters based on 140cm roll.

Leather usage: 5 square meters based on a yield of 60% pr hide.

COM must be approved by &Tradition to ensure suitability for upholstery.

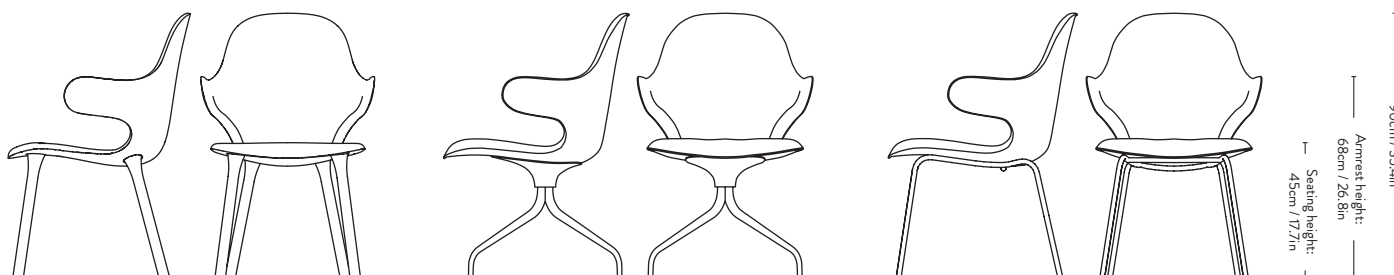

Catch^{JH13 & JH14} Jaime Hayon 2017

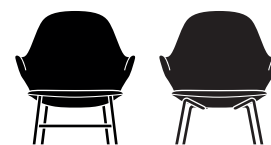

Price group	Upholstery	Model	Base	Lead time	Weight	PRICE EX. VAT (SEK)	PRICE INC. VAT (SEK)
Fabric gr. 1	Hot Madison, Remix, Re-Wool	JH13	Flat Tube	6-8 weeks	14.00 kg	14.920	18.650
		JH14	Round Tube	6-8 weeks	14.00 kg	13.724	17.155
Fabric gr. 2	Canvas, Barnum, Fiord, Ritz	JH13	Flat Tube	6-8 weeks	14.00 kg	16.112	20.140
		JH14	Round Tube	6-8 weeks	14.00 kg	14.920	18.650
Fabric gr. 3	Clay, Hallingdal, Steelcut Quartet, Steelcut Trio	JH13	Flat Tube	6-8 weeks	14.00 kg	16.712	20.890
		JH14	Round Tube	6-8 weeks	14.00 kg	15.516	19.395
Fabric gr. 4	Acca, Cifrado, Ecriture, Moss, Uniform Melange, Vidar	JH13	Flat Tube	6-8 weeks	14.00 kg	18.500	23.125
		JH14	Round Tube	6-8 weeks	14.00 kg	17.308	21.635
Fabric gr. 5	Karakorum, Sisu	JH13	Flat Tube	6-8 weeks	14.00 kg	24.472	30.590
		JH14	Round Tube	6-8 weeks	14.00 kg	23.276	29.095
Fabric gr. 6	Fuse, Gentle	JH13	Flat Tube	6-8 weeks	14.00 kg	26.860	33.575
		JH14	Round Tube	6-8 weeks	14.00 kg	25.664	32.080
Leather	Tailor Semi-aniline leather	JH13	Flat Tube	6-8 weeks	14.00 kg	19.696	24.620
		JH14	Round Tube	6-8 weeks	14.00 kg	18.500	23.125
Leather	Noble Aniline leather	JH13	Flat Tube	6-8 weeks	14.00 kg	23.276	29.095
		JH14	Round Tube	6-8 weeks	14.00 kg	22.084	27.605
Leather	Elmosoft Semi-aniline leather	JH13	Flat Tube	6-8 weeks	14.00 kg	27.756	34.695
		JH14	Round Tube	6-8 weeks	14.00 kg	26.264	32.830
Fabric COM	COM Fabric	JH13	Flat Tube	6-8 weeks	14.00 kg	14.920	18.650
		JH14	Round Tube	6-8 weeks	14.00 kg	13.724	17.155

Base Finish

Flat Tube	Warm Black Powder Coated
Round Tube	Warm Black Powder Coated

Material: Moulded PU foam and HR foam.

Fabric usage: 3 meters based on 140cm roll.

Leather usage: 6 square meters based on a yield of 60% pr hide.

COM must be approved by &Tradition to ensure suitability for upholstery.

Felt gliders installed as standard.



Catch^{JH16 & JH17} Jaime Hayon 2017



Price group	Upholstery	Model	Base	Lead time	Weight	PRICE EX. VAT (SEK)	PRICE INC. VAT (SEK)
Fabric gr. 1	Hot Madison, Remix, Re-Wool	JH16	Tube	6-8 weeks	11.20 kg	8.828	11.035
		JH17	Tube	6-8 weeks	11.50 kg	8.828	11.035
Fabric gr. 2	Canvas, Barnum, Fiord, Ritz	JH16	Tube	6-8 weeks	11.20 kg	9.428	11.785
		JH17	Tube	6-8 weeks	11.50 kg	9.428	11.785
Fabric gr. 3	Clay, Hallingdal, Steelcut Quartet, Steelcut Trio	JH16	Tube	6-8 weeks	11.20 kg	9.664	12.080
		JH17	Tube	6-8 weeks	11.50 kg	9.664	12.080
Fabric gr. 4	Acca, Cifrado, Ecriture, Moss, Uniform Melange, Vidar	JH16	Tube	6-8 weeks	11.20 kg	10.620	13.275
		JH17	Tube	6-8 weeks	11.50 kg	10.620	13.275
Fabric gr. 5	Karakorum, Sisu	JH16	Tube	6-8 weeks	11.20 kg	12.172	15.215
		JH17	Tube	6-8 weeks	11.50 kg	12.172	15.215
Fabric gr. 6	Fuse, Gentle	JH16	Tube	6-8 weeks	11.20 kg	13.724	17.155
		JH17	Tube	6-8 weeks	11.50 kg	13.724	17.155
Leather	Tailor Semi-aniline leather	JH16	Tube	6-8 weeks	11.20 kg	13.008	16.260
		JH17	Tube	6-8 weeks	11.50 kg	13.008	16.260
Leather	Noble Aniline leather	JH16	Tube	6-8 weeks	11.20 kg	15.160	18.950
		JH17	Tube	6-8 weeks	11.50 kg	15.160	18.950
Leather	Elmosoft Semi-aniline leather	JH16	Tube	6-8 weeks	11.20 kg	16.948	21.185
		JH17	Tube	6-8 weeks	11.50 kg	16.948	21.185
Fabric COM	COM Fabric	JH16	Tube	6-8 weeks	11.20 kg	8.828	11.035
		JH17	Tube	6-8 weeks	11.50 kg	8.828	11.035

Base Finish

Tube Powder Coated Black

Material: Moulded PU foam and HR foam.

Fabric usage: 1.8 meters based on 140cm roll.

Leather usage: 5 square meters based on a yield of 60% pr hide.

COM must be approved by &Tradition to ensure suitability for upholstery.

Plastic gliders installed as standard.

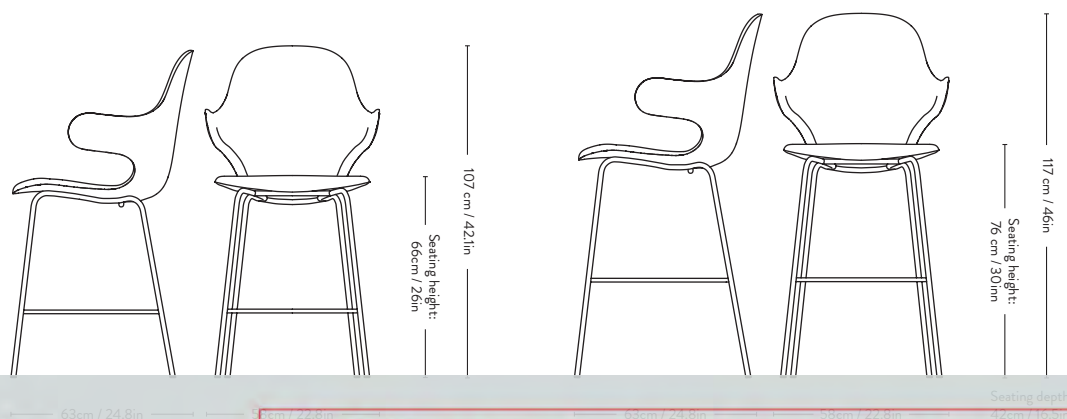

Elefy ^{JH28} Jaime Hayon 2019



Item code	Shell Colour	Model	Base	Lead time	Weight	PRICE EX. VAT (SEK)	PRICE INC. VAT (SEK)
JH	Black	JH28	Black	2-3 weeks	7.80 kg	2.384	2.980
JH	White	JH28	Black	2-3 weeks	7.80 kg	2.384	2.980
JH	Soft Beige	JH28	Black	2-3 weeks	7.80 kg	2.384	2.980
JH	Midnight Blue	JH28	Black	2-3 weeks	7.80 kg	2.384	2.980
JH	Copper Brown	JH28	Black	2-3 weeks	7.80 kg	2.384	2.980

Base **Finish**

Steel Tube Black

Material: Polypropylene, steel tube.

Plastic gliders installed as standard.
Felt gliders available upon request.

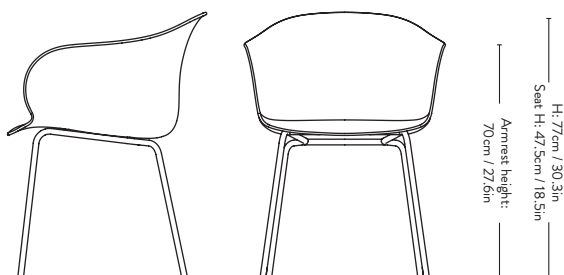

Elefy JH29

Jaime Hayon

2019



Price group	Upholstery	Model	Base	Lead time	Weight	PRICE EX. VAT (SEK)	PRICE INC. VAT (SEK)
Fabric gr. 1	Hot Madison, Remix, Re-Wool	JH29	Black	3-6 weeks	7.80 kg	5.128	6.410
Fabric gr. 2	Canvas, Barnum, Fiord, Ritz	JH29	Black	3-6 weeks	7.80 kg	5.844	7.305
Fabric gr. 3	Clay, Hallingdal, Steelcut Quartet, Steelcut Trio	JH29	Black	3-6 weeks	7.80 kg	6.084	7.605
Fabric gr. 4	Acca, Cifrado, Ecriture, Moss, Uniform Melange, Vidar	JH29	Black	3-6 weeks	7.80 kg	6.800	8.500
Fabric gr. 5	Karakorum, Sisu	JH29	Black	3-6 weeks	7.80 kg	9.068	11.335
Fabric gr. 6	Fuse, Gentle	JH29	Black	3-6 weeks	7.80 kg	9.904	12.380
Leather	Tailor Semi-aniline leather	JH29	Black	3-6 weeks	7.80 kg	8.592	10.740
Leather	Noble Aniline leather	JH29	Black	3-6 weeks	7.80 kg	9.068	11.335
Leather	Elmosoft Semi-aniline leather	JH29	Black	3-6 weeks	7.80 kg	9.548	11.935
Fabric COM	COM Fabric	JH29	Black	3-6 weeks	7.80 kg	5.128	6.410

Base Finish

Steel Tube Black

Material: Polypropylene, HR foam, steel tube, fabric or leather upholstery.

Fabric usage: 1.7 meters based on 140cm roll.

Leather usage: 3 square meters based on a yield of 60% pr hide.

COM must be approved by &Tradition to ensure suitability for upholstery.

Plastic gliders installed as standard.

Felt gliders available upon request.

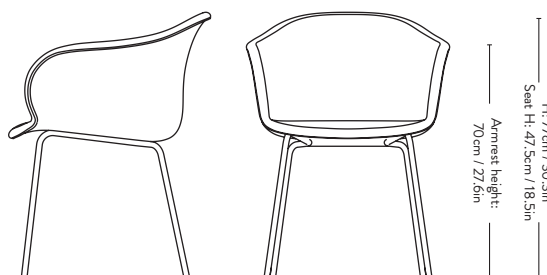

Elefy JH30

Jaime Hayon

2019



Item code	Product	Model	Base	Lead time	Weight	PRICE EX. VAT (SEK)	PRICE INC. VAT (SEK)
JH	Black	JH30	Oak	2-3 weeks	8.80 kg	3.336	4.170
		JH30	Black	2-3 weeks	8.80 kg	3.336	4.170
		JH30	Walnut	2-3 weeks	8.80 kg	3.696	4.620
JH	White	JH30	Oak	2-3 weeks	8.80 kg	3.336	4.170
		JH30	Black	2-3 weeks	8.80 kg	3.336	4.170
		JH30	Walnut	2-3 weeks	8.80 kg	3.696	4.620
JH	Soft Beige	JH30	Oak	2-3 weeks	8.80 kg	3.336	4.170
		JH30	Black	2-3 weeks	8.80 kg	3.336	4.170
		JH30	Walnut	2-3 weeks	8.80 kg	3.696	4.620
JH	Midnight Blue	JH30	Oak	2-3 weeks	8.80 kg	3.336	4.170
		JH30	Black	2-3 weeks	8.80 kg	3.336	4.170
		JH30	Walnut	2-3 weeks	8.80 kg	3.696	4.620
JH	Copper Brown	JH30	Oak	2-3 weeks	8.80 kg	3.336	4.170
		JH30	Black	2-3 weeks	8.80 kg	3.336	4.170
		JH30	Walnut	2-3 weeks	8.80 kg	3.696	4.620

Base	Finish
Solid Oak	Clear or Black water based Lacquered Oak
Solid Walnut	Water based lacquered Walnut

Material: Polypropylene, solid wood.

Felt gliders installed as standard.

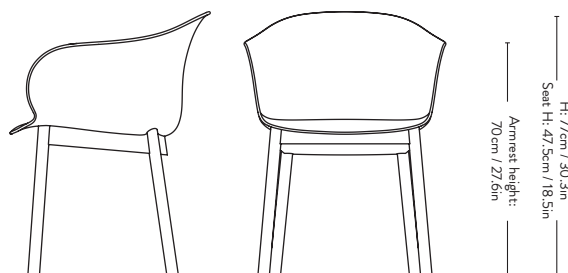

Elefy JH31

Jaime Hayon

2019



Price group	Upholstery	Model	Base	Lead time	Weight	PRICE EX. VAT (SEK)	PRICE INC. VAT (SEK)
Fabric gr. 1	Hot Madison, Remix, Re-Wool	JH31	Black	3-6 weeks	8.80 kg	6.084	7.605
		JH31	Oak	3-6 weeks	8.80 kg	6.084	7.605
		JH31	Walnut	3-6 weeks	8.80 kg	6.440	8.050
Fabric gr. 2	Canvas, Barnum, Fiord, Ritz	JH31	Black	3-6 weeks	8.80 kg	6.800	8.500
		JH31	Oak	3-6 weeks	8.80 kg	6.800	8.500
		JH31	Walnut	3-6 weeks	8.80 kg	7.160	8.950
Fabric gr. 3	Clay, Hallingdal, Steelcut Quartet, Steelcut Trio	JH31	Black	3-6 weeks	8.80 kg	6.920	8.650
		JH31	Oak	3-6 weeks	8.80 kg	6.920	8.650
		JH31	Walnut	3-6 weeks	8.80 kg	7.276	9.095
Fabric gr. 4	Acca, Cifrado, Ecriture, Moss, Uniform Melange, Vidar	JH31	Black	3-6 weeks	8.80 kg	7.756	9.695
		JH31	Oak	3-6 weeks	8.80 kg	7.756	9.695
		JH31	Walnut	3-6 weeks	8.80 kg	8.112	10.140
Fabric gr. 5	Karakorum, Sisu	JH31	Black	3-6 weeks	8.80 kg	10.024	12.530
		JH31	Oak	3-6 weeks	8.80 kg	10.024	12.530
		JH31	Walnut	3-6 weeks	8.80 kg	10.384	12.980
Fabric gr. 6	Fuse, Gentle	JH31	Black	3-6 weeks	8.80 kg	10.980	13.725
		JH31	Oak	3-6 weeks	8.80 kg	10.980	13.725
		JH31	Walnut	3-6 weeks	8.80 kg	11.336	14.170
Leather	Tailor Semi-aniline leather	JH31	Black	3-6 weeks	8.80 kg	9.548	11.935
		JH31	Oak	3-6 weeks	8.80 kg	9.548	11.935
		JH31	Walnut	3-6 weeks	8.80 kg	9.904	12.380
Leather	Noble Aniline leather	JH31	Black	3-6 weeks	8.80 kg	10.024	12.530
		JH31	Oak	3-6 weeks	8.80 kg	10.024	12.530
		JH31	Walnut	3-6 weeks	8.80 kg	10.384	12.980
Leather	Elmosoft Semi-aniline leather	JH31	Black	3-6 weeks	8.80 kg	10.500	13.125
		JH31	Oak	3-6 weeks	8.80 kg	10.500	13.125
		JH31	Walnut	3-6 weeks	8.80 kg	10.860	13.575
Fabric COM	COM Fabric	JH31	Black	3-6 weeks	8.80 kg	6.084	7.605
		JH31	Oak	3-6 weeks	8.80 kg	6.084	7.605
		JH31	Walnut	3-6 weeks	8.80 kg	6.440	8.050

Base	Finish
Solid Oak	Clear or Black water based Lacquered Oak
Solid Walnut	Water based lacquered Walnut

Material: Polypropylene, HR foam, solid wood, fabric or leather upholstery.

Fabric usage: 1.7 meters based on 140cm roll.

Leather usage: 3 square meters based on a yield of 60% pr hide.

COM must be approved by &Tradition to ensure suitability for upholstery.

Felt gliders installed as standard.

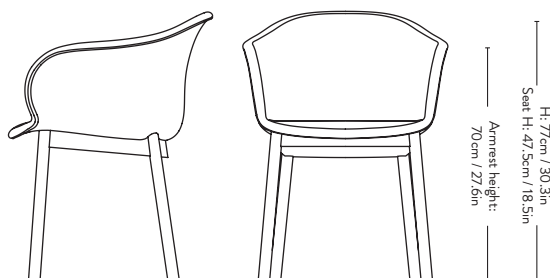

Elefy ^{JH32} Jaime Hayon 2020



Item code	Product	Model	Base	Lead time	Weight	PRICE EX. VAT (SEK)	PRICE INC. VAT (SEK)
JH	Black	JH32	Black	2-3 weeks	9.00 kg	3.696	4.620
		JH32	Polished Aluminium	2-3 weeks	9.00 kg	3.696	4.620
JH	White	JH32	Black	2-3 weeks	9.00 kg	3.696	4.620
		JH32	Polished Aluminium	2-3 weeks	9.00 kg	3.696	4.620
JH	Soft Beige	JH32	Black	2-3 weeks	9.00 kg	3.696	4.620
		JH32	Polished Aluminium	2-3 weeks	9.00 kg	3.696	4.620
JH	Midnight Blue	JH32	Black	2-3 weeks	9.00 kg	3.696	4.620
		JH32	Polished Aluminium	2-3 weeks	9.00 kg	3.696	4.620
JH	Copper Brown	JH32	Black	2-3 weeks	9.00 kg	3.696	4.620
		JH32	Polished Aluminium	2-3 weeks	9.00 kg	3.696	4.620

Base	Finish
Swivel	Black, Polished Aluminium

Material: Polypropylene and aluminium.

Plastic gliders installed as standard.
Felt gliders are available upon request.

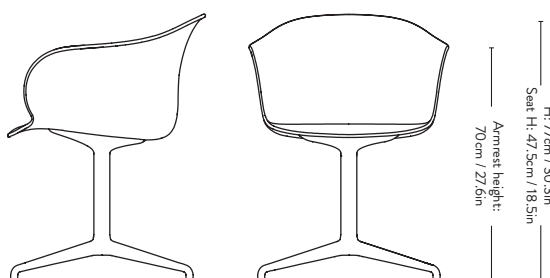

Elefy ^{JH33} Jaime Hayon 2020



Price group	Upholstery	Model	Base	Lead time	Weight	PRICE EX. VAT (SEK)	PRICE INC. VAT (SEK)
Fabric gr. 1	Hot Madison, Remix, Re-Wool	JH33	Black	3-6 weeks	10.70 kg	6.324	7.905
		JH33	Polished Aluminium	3-6 weeks	10.70 kg	6.324	7.905
Fabric gr. 2	Canvas, Barnum, Fiord, Ritz	JH33	Black	3-6 weeks	10.70 kg	7.040	8.800
		JH33	Polished Aluminium	3-6 weeks	10.70 kg	7.040	8.800
Fabric gr. 3	Clay, Hallingdal, Steelcut Quartet, Steelcut Trio	JH33	Black	3-6 weeks	10.70 kg	7.160	8.950
		JH33	Polished Aluminium	3-6 weeks	10.70 kg	7.160	8.950
Fabric gr. 4	Acca, Cifrado, Ecriture, Moss, Uniform Melange, Vidar	JH33	Black	3-6 weeks	10.70 kg	7.996	9.995
		JH33	Polished Aluminium	3-6 weeks	10.70 kg	7.996	9.995
Fabric gr. 5	Karakorum, Sisu	JH33	Black	3-6 weeks	10.70 kg	10.264	12.830
		JH33	Polished Aluminium	3-6 weeks	10.70 kg	10.264	12.830
Fabric gr. 6	Fuse, Gentle	JH33	Black	3-6 weeks	10.70 kg	11.216	14.020
		JH33	Polished Aluminium	3-6 weeks	10.70 kg	11.216	14.020
Leather	Tailor Semi-aniline leather	JH33	Black	3-6 weeks	10.70 kg	9.784	12.230
		JH33	Polished Aluminium	3-6 weeks	10.70 kg	9.784	12.230
Leather	Noble Aniline leather	JH33	Black	3-6 weeks	10.70 kg	10.264	12.830
		JH33	Polished Aluminium	3-6 weeks	10.70 kg	10.264	12.830
Leather	Elmosoft Semi-aniline leather	JH33	Black	3-6 weeks	10.70 kg	10.740	13.425
		JH33	Polished Aluminium	3-6 weeks	10.70 kg	10.740	13.425
Fabric COM	COM Fabric	JH33	Black	3-6 weeks	10.70 kg	6.324	7.905
		JH33	Polished Aluminium	3-6 weeks	10.70 kg	6.324	7.905

Base	Finish
Swivel	Black, Polished Aluminium

Material: Polypropylene, HR foam, aluminium swivel base, fabric or leather upholstery.

Fabric usage: 1.7 meters based on 140cm roll.

Leather usage: 3 square meters based on a yield of 60% pr hide.

COM must be approved by &Tradition to ensure suitability for upholstery.

Plastic gliders installed as standard.
Felt gliders available upon request.

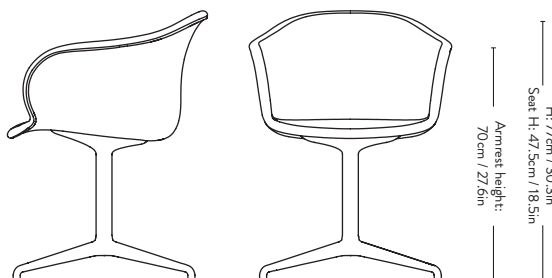

Elefy ^{JH34} Jaime Hayon 2020



Item code	Product	Model	Base	Lead time	Weight	PRICE EX. VAT (SEK)	PRICE INC. VAT (SEK)
JH	Black	JH34	Black	2-3 weeks	9.00 kg	4.172	5.215
		JH34	Polished Aluminium	2-3 weeks	9.00 kg	4.172	5.215
JH	White	JH34	Black	2-3 weeks	9.00 kg	4.172	5.215
		JH34	Polished Aluminium	2-3 weeks	9.00 kg	4.172	5.215
JH	Soft Beige	JH34	Black	2-3 weeks	9.00 kg	4.172	5.215
		JH34	Polished Aluminium	2-3 weeks	9.00 kg	4.172	5.215
JH	Midnight Blue	JH34	Black	2-3 weeks	9.00 kg	4.172	5.215
		JH34	Polished Aluminium	2-3 weeks	9.00 kg	4.172	5.215
JH	Copper Brown	JH34	Black	2-3 weeks	9.00 kg	4.172	5.215
		JH34	Polished Aluminium	2-3 weeks	9.00 kg	4.172	5.215

Base	Finish
Swivel	Black, Polished Aluminium

Material: Polypropylene and aluminium swivel base with return function.

Plastic gliders installed as standard.
Felt gliders are available upon request.

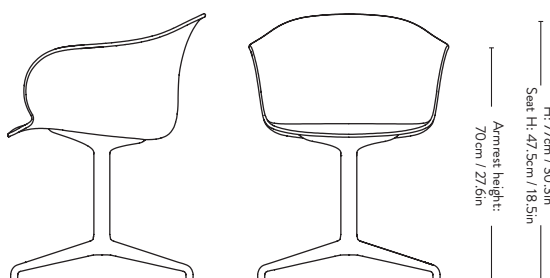

Elefy JH35

Jaime Hayon

2020



Price group	Upholstery	Model	Base	Lead time	Weight	PRICE EX. VAT (SEK)	PRICE INC. VAT (SEK)
Fabric gr. 1	Hot Madison, Remix, Re-Wool	JH35	Black	3-6 weeks	10.70 kg	6.800	8.500
		JH35	Polished Aluminium	3-6 weeks	10.70 kg	6.800	8.500
Fabric gr. 2	Canvas, Barnum, Fiord, Ritz	JH35	Black	3-6 weeks	10.70 kg	7.516	9.395
		JH35	Polished Aluminium	3-6 weeks	10.70 kg	7.516	9.395
Fabric gr. 3	Clay, Hallingdal, Steelcut Quartet, Steelcut Trio	JH35	Black	3-6 weeks	10.70 kg	7.516	9.395
		JH35	Polished Aluminium	3-6 weeks	10.70 kg	7.516	9.395
Fabric gr. 4	Acca, Cifrado, Ecriture, Moss, Uniform Melange, Vidar	JH35	Black	3-6 weeks	10.70 kg	8.472	10.590
		JH35	Polished Aluminium	3-6 weeks	10.70 kg	8.472	10.590
Fabric gr. 5	Karakorum, Sisu	JH35	Black	3-6 weeks	10.70 kg	10.740	13.425
		JH35	Polished Aluminium	3-6 weeks	10.70 kg	10.740	13.425
Fabric gr. 6	Fuse, Gentle	JH35	Black	3-6 weeks	10.70 kg	11.696	14.620
		JH35	Polished Aluminium	3-6 weeks	10.70 kg	11.696	14.620
Leather	Tailor Semi-aniline leather	JH35	Black	3-6 weeks	10.70 kg	10.264	12.830
		JH35	Polished Aluminium	3-6 weeks	10.70 kg	10.264	12.830
Leather	Noble Aniline leather	JH35	Black	3-6 weeks	10.70 kg	10.740	13.425
		JH35	Polished Aluminium	3-6 weeks	10.70 kg	10.740	13.425
Leather	Elmosoft Semi-aniline leather	JH35	Black	3-6 weeks	10.70 kg	11.216	14.020
		JH35	Polished Aluminium	3-6 weeks	10.70 kg	11.216	14.020
Fabric COM	COM Fabric	JH35	Black	3-6 weeks	10.70 kg	6.800	8.500
		JH35	Polished Aluminium	3-6 weeks	10.70 kg	6.800	8.500

Base	Finish
Swivel	Black, Polished Aluminium

Material: Polypropylene, HR foam, aluminium swivel base, fabric or leather upholstery.

Fabric usage: 1.7 meters based on 140cm roll.

Leather usage: 3 square meters based on a yield of 60% pr hide.

COM must be approved by &Tradition to ensure suitability for upholstery.

Plastic gliders installed as standard.
Felt gliders available upon request.

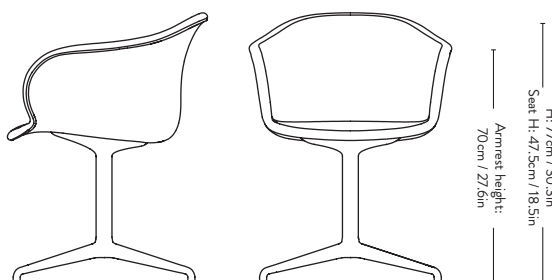

Elefy ^{JH36} Jaime Hayon 2020



Item code	Product	Model	Base	Lead time	Weight	PRICE EX. VAT (SEK)	PRICE INC. VAT (SEK)
JH	Black	JH36	Black	2-3 weeks	9.50 kg	4.172	5.215
		JH36	Polished Aluminium	2-3 weeks	9.50 kg	4.172	5.215
JH	White	JH36	Black	2-3 weeks	9.50 kg	4.172	5.215
		JH36	Polished Aluminium	2-3 weeks	9.50 kg	4.172	5.215
JH	Soft Beige	JH36	Black	2-3 weeks	9.50 kg	4.172	5.215
		JH36	Polished Aluminium	2-3 weeks	9.50 kg	4.172	5.215
JH	Midnight Blue	JH36	Black	2-3 weeks	9.50 kg	4.172	5.215
		JH36	Polished Aluminium	2-3 weeks	9.50 kg	4.172	5.215
JH	Copper Brown	JH36	Black	2-3 weeks	9.50 kg	4.172	5.215
		JH36	Polished Aluminium	2-3 weeks	9.50 kg	4.172	5.215

Base Finish

Swivel Black, Polished Aluminium

Material: Polypropylene and aluminium base with castors.

Castors in matching colour are installed as standard.

Suitable for all floor types.

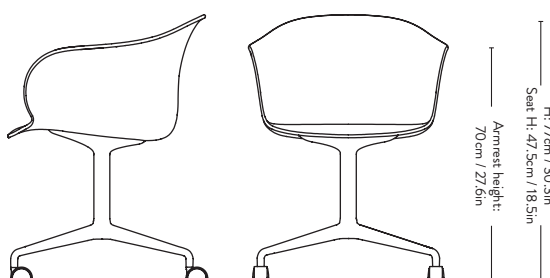

58cm / 22.8in

57.5cm / 22.6in

Seating depth: 43cm / 16.9in

22% RABATT SKA DRAS AV PÅ ANGIVNA PRISER

Elefy^{JH37}

Jaime Hayon

2020



Price group	Upholstery	Model	Base	Lead time	Weight	PRICE EX. VAT (SEK)	PRICE INC. VAT (SEK)
Fabric gr. 1	Hot Madison, Remix, Re-Wool	JH37	Black	3-6 weeks	11.50 kg	6.800	8.500
		JH37	Polished Aluminium	3-6 weeks	11.50 kg	6.800	8.500
Fabric gr. 2	Canvas, Barnum, Fiord, Ritz	JH37	Black	3-6 weeks	11.50 kg	7.516	9.395
		JH37	Polished Aluminium	3-6 weeks	11.50 kg	7.516	9.395
Fabric gr. 3	Clay, Hallingdal, Steelcut Quartet, Steelcut Trio	JH37	Black	3-6 weeks	11.50 kg	7.636	9.545
		JH37	Polished Aluminium	3-6 weeks	11.50 kg	7.636	9.545
Fabric gr. 4	Acca, Cifrado, Ecriture, Moss, Uniform Melange, Vidar	JH37	Black	3-6 weeks	11.50 kg	8.472	10.590
		JH37	Polished Aluminium	3-6 weeks	11.50 kg	8.472	10.590
Fabric gr. 5	Karakorum, Sisu	JH37	Black	3-6 weeks	11.50 kg	10.740	13.425
		JH37	Polished Aluminium	3-6 weeks	11.50 kg	10.740	13.425
Fabric gr. 6	Fuse, Gentle	JH37	Black	3-6 weeks	11.50 kg	11.696	14.620
		JH37	Polished Aluminium	3-6 weeks	11.50 kg	11.696	14.620
Leather	Tailor Semi-aniline leather	JH37	Black	3-6 weeks	11.50 kg	10.264	12.830
		JH37	Polished Aluminium	3-6 weeks	11.50 kg	10.264	12.830
Leather	Noble Aniline leather	JH37	Black	3-6 weeks	11.50 kg	10.740	13.425
		JH37	Polished Aluminium	3-6 weeks	11.50 kg	10.740	13.425
Leather	Elmosoft Semi-aniline leather	JH37	Black	3-6 weeks	11.50 kg	11.216	14.020
		JH37	Polished Aluminium	3-6 weeks	11.50 kg	11.216	14.020
Fabric COM	COM Fabric	JH37	Black	3-6 weeks	11.50 kg	6.800	8.500
		JH37	Polished Aluminium	3-6 weeks	11.50 kg	6.800	8.500

Base Finish

Swivel Black, Polished Aluminium

Material: Polypropylene, HR foam, aluminium base with castors, fabric or leather upholstery.

Fabric usage: 1.7 meters based on 140cm roll.

Leather usage: 3 square meters based on a yield of 60% pr hide.

COM must be approved by &Tradition to ensure suitability for upholstery.

Castors in matching colour are installed as standard.

Suitable for all floor types

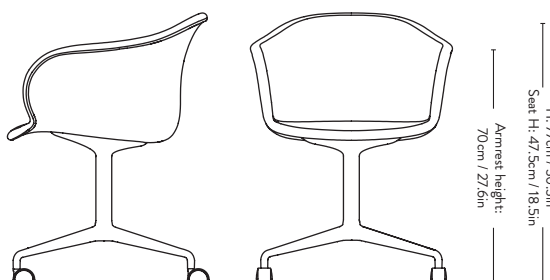

In Between ^{SK1} Sami Kallio 2013



Item code	Product	Model	Colli qty.	Lead time	Weight	PRICE EX. VAT (SEK)	PRICE INC. VAT (SEK)
82010100	Smoked Oiled Oak	SK1	2 pcs	Stock item	7.00 kg	3.936	4.920
82010192	Oiled Oak	SK1	2 pcs	Stock item	7.00 kg	3.936	4.920
82010194	Black Lacquered Oak	SK1	2 pcs	Stock item	7.00 kg	3.936	4.920
82010196	Oiled Walnut	SK1	2 pcs	Stock item	7.00 kg	5.368	6.710

Frame **Finish**

Oak Oiled Oak, Smoked Oiled Oak, Black Lacquered Oak
Walnut Oiled Walnut

Material: Solid wood and formpressed veneer.

Felt gliders installed as standard.



EU Ecolabel certified, validating high standards of durability, circular design, and responsible use of chemicals. Please contact our sales team for a list of EU Ecolabel compliant combinations.

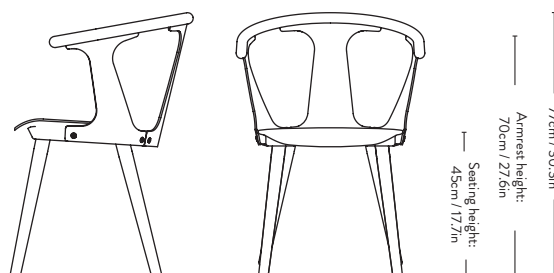

In Between ^{SK2} Sami Kallio 2013



Item code	Product	Model	Colli qty.	Lead time	Weight	PRICE EX. VAT (SEK)	PRICE INC. VAT (SEK)
82010310	Oiled Oak w. Fiord 251	SK2	2 pcs	Stock item	7.00 kg	4.772	5.965
82010312	Black Lacquered Oak w. Fiord 191	SK2	2 pcs	Stock item	7.00 kg	4.772	5.965
82010311	Smoked Oiled Oak w. Fiord 171	SK2	2 pcs	Stock item	7.00 kg	4.772	5.965
82010320	Oiled Oak w. Noble Aniline Cognac Leather	SK2	2 pcs	Stock item	7.00 kg	5.844	7.305
82010325	Black Lacquered Oak w. Noble Aniline Black Leather	SK2	2 pcs	Stock item	7.00 kg	5.844	7.305
82010330	Smoked Oiled Oak w. Noble Aniline Black Leather	SK2	2 pcs	Stock item	7.00 kg	5.844	7.305

Price group	Product	Model	Base	Lead time	Weight	PRICE EX. VAT (SEK)	PRICE INC. VAT (SEK)
Fabric gr. 1	Hot Madison, Remix, Re-Wool	SK2	Oak	6-8 weeks	7.00 kg	4.772	5.965
			Walnut	6-8 weeks	7.00 kg	6.324	7.905
Fabric gr. 2	Canvas, Barnum, Fiord, Ritz	SK2	Oak	6-8 weeks	7.00 kg	5.368	6.710
			Walnut	6-8 weeks	7.00 kg	6.920	8.650
Fabric gr. 3	Clay, Hallingdal, Steelcut Quartet, Steelcut Trio	SK2	Oak	6-8 weeks	7.00 kg	5.488	6.860
			Walnut	6-8 weeks	7.00 kg	7.040	8.800
Fabric gr. 4	Acca, Cifrado, Ecriture, Moss, Uniform Melange, Vidar	SK2	Oak	6-8 weeks	7.00 kg	5.724	7.155
			Walnut	6-8 weeks	7.00 kg	7.276	9.095
Fabric gr. 5	Karakorum, Sisu	SK2	Oak	6-8 weeks	7.00 kg	5.964	7.455
			Walnut	6-8 weeks	7.00 kg	7.516	9.395
Fabric gr. 6	Fuse, Gentle	SK2	Oak	6-8 weeks	7.00 kg	6.560	8.200
			Walnut	6-8 weeks	7.00 kg	8.232	10.290
Leather	Tailor Semi-aniline leather	SK2	Oak	6-8 weeks	7.00 kg	5.724	7.155
			Walnut	6-8 weeks	7.00 kg	7.276	9.095
Leather	Noble Aniline leather	SK2	Oak	6-8 weeks	7.00 kg	5.964	7.455
			Walnut	6-8 weeks	7.00 kg	7.516	9.395
Leather	Elmosoft Semi-aniline leather	SK2	Oak	6-8 weeks	7.00 kg	6.324	7.905
			Walnut	6-8 weeks	7.00 kg	7.876	9.845
Fabric COM	COM Fabric	SK2	Oak	6-8 weeks	7.00 kg	4.772	5.965
			Walnut	6-8 weeks	7.00 kg	6.324	7.905

Frame Finish

Oak	Oiled Oak, Smoked Oiled Oak, Black Lacquered Oak
Walnut	Oiled Walnut

Material: Solid wood, formpressed veneer and HR foam.

Fabric usage: 0.36 meter based on a 140 cm roll.

Leather usage: 0.36 square meters based on a yield of 60% pr hide.

COM must be approved by &Tradition to ensure suitability for upholstery.

Felt gliders installed as standard.



EU Ecolabel certified, validating high standards of durability, circular design, and responsible use of chemicals. Please contact our sales team for a list of EU Ecolabel compliant combinations.

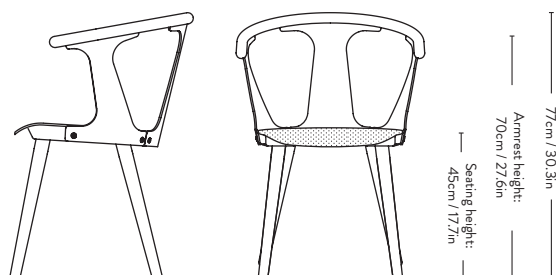

In Between ^{SK7 & SK8} Sami Kallio 2017



Item code	Product	Model	Colli qty.	Lead time	Weight	PRICE EX. VAT (SEK)	PRICE INC. VAT (SEK)
82030700	Smoked Oiled Oak	SK7	1 pc	Stock item	6.50 kg	4.772	5.965
82030792	Oiled Oak	SK7	1 pc	Stock item	6.50 kg	4.772	5.965
82030794	Black Lacquered Oak	SK7	1 pc	Stock item	6.50 kg	4.772	5.965

Price group	Upholstery	Model	Lead time	Weight	PRICE EX. VAT (SEK)	PRICE INC. VAT (SEK)
Fabric gr. 1	Hot Madison, Remix, Re-Wool	SK8	6-8 weeks	7.00 kg	5.724	7.155
Fabric gr. 2	Canvas, Barnum, Fiord, Ritz	SK8	6-8 weeks	7.00 kg	6.204	7.755
Fabric gr. 3	Clay, Hallingdal, Steelcut Quartet, Steelcut Trio	SK8	6-8 weeks	7.00 kg	6.264	7.830
Fabric gr. 4	Acca, Cifrado, Ecriture, Moss, Uniform Melange, Vidar	SK8	6-8 weeks	7.00 kg	6.324	7.905
Fabric gr. 5	Karakorum, Sisu	SK8	6-8 weeks	7.00 kg	6.800	8.500
Fabric gr. 6	Fuse, Gentle	SK8	6-8 weeks	7.00 kg	7.516	9.395
Leather	Tailor Semi-aniline leather	SK8	6-8 weeks	7.00 kg	6.560	8.200
Leather	Noble Aniline leather	SK8	6-8 weeks	7.00 kg	6.800	8.500
Leather	Elmosoft Semi-aniline leather	SK8	6-8 weeks	7.00 kg	7.160	8.950
Fabric COM	COM Fabric	SK8	6-8 weeks	7.00 kg	5.724	7.155



EU Ecolabel certified, validating high standards of durability, circular design, and responsible use of chemicals. Please contact our sales team for a list of EU Ecolabel compliant combinations.

Frame Finish

Wood Oiled Oak, Smoked Oiled Oak, Black Lacquered Oak

Material: Solid wood, formpressed veneer and HR foam.

Fabric usage: 0.36 meter based on a 140 cm roll.

Leather usage: 0.36 square meters based on a yield of 60% pr hide.

COM must be approved by &Tradition to ensure suitability for upholstery.

Felt gliders installed as standard.

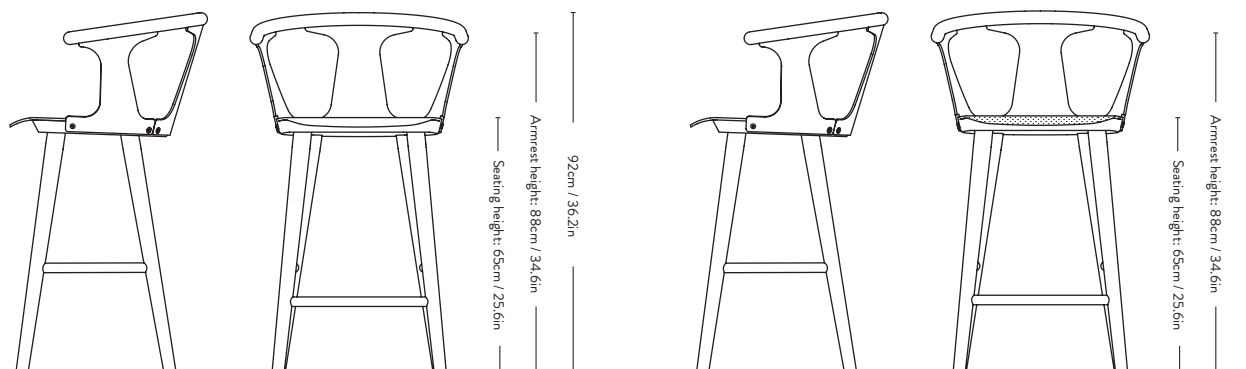

In Between ^{SK9 & SK10} Sami Kallio 2017



Item code	Product	Model	Colli qty.	Lead time	Weight	PRICE EX. VAT (SEK)	PRICE INC. VAT (SEK)
82030800	Smoked Oiled Oak	SK9	1 pc	Stock item	6.50 kg	4.772	5.965
82030892	Oiled Oak	SK9	1 pc	Stock item	6.50 kg	4.772	5.965
82030894	Black Lacquered Oak	SK9	1 pc	Stock item	6.50 kg	4.772	5.965

Price group	Upholstery	Model	Lead time	Weight	PRICE EX. VAT (SEK)	PRICE INC. VAT (SEK)
Fabric gr. 1	Hot Madison, Remix, Re-Wool	SK10	6-8 weeks	7.00 kg	5.724	7.155
Fabric gr. 2	Canvas, Barnum, Fiord, Ritz	SK10	6-8 weeks	7.00 kg	6.204	7.755
Fabric gr. 3	Clay, Hallingdal, Steelcut Quartet, Steelcut Trio	SK10	6-8 weeks	7.00 kg	6.264	7.830
Fabric gr. 4	Acca, Cifrado, Ecriture, Moss, Uniform Melange, Vidar	SK10	6-8 weeks	7.00 kg	6.324	7.905
Fabric gr. 5	Karakorum, Sisu	SK10	6-8 weeks	7.00 kg	6.800	8.500
Fabric gr. 6	Fuse, Gentle	SK10	6-8 weeks	7.00 kg	7.516	9.395
Leather	Tailor Semi-aniline leather	SK10	6-8 weeks	7.00 kg	6.560	8.200
Leather	Noble Aniline leather	SK10	6-8 weeks	7.00 kg	6.800	8.500
Leather	Elmosoft Semi-aniline leather	SK10	6-8 weeks	7.00 kg	7.160	8.950
Fabric COM	COM Fabric	SK10	6-8 weeks	7.00 kg	5.724	7.155



EU Ecolabel certified, validating high standards of durability, circular design, and responsible use of chemicals. Please contact our sales team for a list of EU Ecolabel compliant combinations.

Frame	Finish
Wood	Oiled Oak, Smoked Oiled Oak, Black Lacquered Oak

Material: Solid wood, formpressed veneer and HR foam.

Fabric usage: 0.36 meter based on a 140 cm roll.

Leather usage: 0.36 square meters based on a yield of 60% pr hide.

COM must be approved by &Tradition to ensure suitability for upholstery.

Felt gliders installed as standard.



Pavilion AV1 & AV2 Anderssen & Voll 2018



Item code	Product	Model	Base	Colli qty.	Lead time	Weight	PRICE EX. VAT (SEK)	PRICE INC. VAT (SEK)
50010092	Oak	AV1	Black	2 pcs	Stock item	7.50 kg	2.740	3.425
50010094	Black Oak	AV1	Black	2 pcs	Stock item	7.50 kg	2.740	3.425
50010096	Walnut	AV1	Black	2 pcs	Stock item	7.50 kg	2.860	3.575
50010193	Oak or Black Oak	AV1	Chrome	2 pcs	6-8 weeks	7.50 kg	2.980	3.725
50010197	Walnut	AV1	Chrome	2 pcs	6-8 weeks	7.50 kg	3.100	3.875
50020092	Oak	AV2	Black	2 pcs	Stock item	8.50 kg	3.336	4.170
50020094	Black Oak	AV2	Black	2 pcs	Stock item	8.50 kg	3.336	4.170
50020096	Walnut	AV2	Black	2 pcs	Stock item	8.50 kg	3.456	4.320
50021192	Oak or Black Oak	AV2	Chrome	2 pcs	6-8 weeks	8.50 kg	3.696	4.620
50021196	Walnut	AV2	Chrome	2 pcs	6-8 weeks	8.50 kg	3.816	4.770

Item code	Product	Lead time	Weight	PRICE EX. VAT (SEK)	PRICE INC. VAT (SEK)
50099990	Pavilion Stacking Trolley	Stock item	20.00 kg	9.548	11.935
50010001	Pavilion chair hanger *can only be used for AV1, AV3 & AV12	6-8 weeks		232	290



EU Ecolabel certified, validating high standards of durability, circular design, and responsible use of chemicals. Please contact our sales team for a list of EU Ecolabel compliant combinations.

Frame Seat & back

Black Water based Lacquered Oak, Black Water Based Lacquered Oak, Water based Lacquered Walnut

Chrome Water based Lacquered Oak, Black Water Based Lacquered Oak, Water based Lacquered Walnut

Material: Steel tubes and formpressed veneer.

Plastic gliders installed as standard.
Felt gliders available upon request (6-8 weeks lead time).

Black base: Black fittings for the front side of the back rest installed as standard. Brass & Chrome fittings available upon request.

Chrome base: Chrome fittings for the front side of the back rest installed as standard. Brass & Black fittings available upon request.

Stackable chair.
With trolley: 12 pcs / Without trolley: 10 pcs

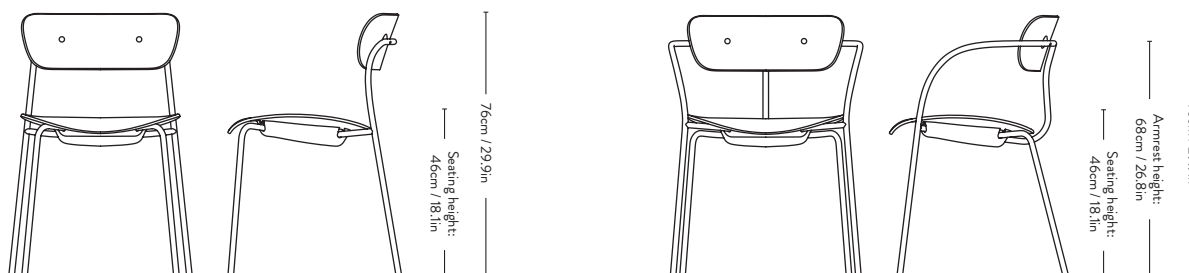

Pavilion ^{AV3} Anderssen & Voll 2018



Price group	Upholstery	Model	Base	Finish	Lead time	Weight	PRICE EX. VAT (SEK)	PRICE INC. VAT (SEK)
Fabric gr. 1	Hot Madison, Remix, Re-Wool	AV3	Black	Black or Oak	6-8 weeks	8.00 kg	3.576	4.470
		AV3	Black	Walnut	6-8 weeks	8.00 kg	3.816	4.770
		AV3	Chrome	Black or Oak	6-8 weeks	8.00 kg	3.936	4.920
		AV3	Chrome	Walnut	6-8 weeks	8.00 kg	3.696	4.620
Fabric gr. 2	Canvas, Barnum, Fiord, Ritz	AV3	Black	Black or Oak	6-8 weeks	8.00 kg	4.172	5.215
		AV3	Black	Walnut	6-8 weeks	8.00 kg	4.412	5.515
		AV3	Chrome	Black or Oak	6-8 weeks	8.00 kg	4.532	5.665
		AV3	Chrome	Walnut	6-8 weeks	8.00 kg	4.292	5.365
Fabric gr. 3	Clay, Hallingdal, Steelcut Quartet, Steelcut Trio	AV3	Black	Black or Oak	6-8 weeks	8.00 kg	4.232	5.290
		AV3	Black	Walnut	6-8 weeks	8.00 kg	4.472	5.590
		AV3	Chrome	Black or Oak	6-8 weeks	8.00 kg	4.592	5.740
		AV3	Chrome	Walnut	6-8 weeks	8.00 kg	4.352	5.440
Fabric gr. 4	Acca, Cifrado, Ecriture, Moss, Uniform Melange, Vidar	AV3	Black	Black or Oak	6-8 weeks	8.00 kg	4.292	5.365
		AV3	Black	Walnut	6-8 weeks	8.00 kg	4.532	5.665
		AV3	Chrome	Black or Oak	6-8 weeks	8.00 kg	4.652	5.815
		AV3	Chrome	Walnut	6-8 weeks	8.00 kg	4.412	5.515
Fabric gr. 5	Karakorum, Sisu	AV3	Black	Black or Oak	6-8 weeks	8.00 kg	4.772	5.965
		AV3	Black	Walnut	6-8 weeks	8.00 kg	5.008	6.260
		AV3	Chrome	Black or Oak	6-8 weeks	8.00 kg	5.128	6.410
		AV3	Chrome	Walnut	6-8 weeks	8.00 kg	4.888	6.110
Fabric gr. 6	Fuse, Gentle	AV3	Black	Black or Oak	6-8 weeks	8.00 kg	5.248	6.560
		AV3	Black	Walnut	6-8 weeks	8.00 kg	5.488	6.860
		AV3	Chrome	Black or Oak	6-8 weeks	8.00 kg	5.604	7.005
		AV3	Chrome	Walnut	6-8 weeks	8.00 kg	5.368	6.710

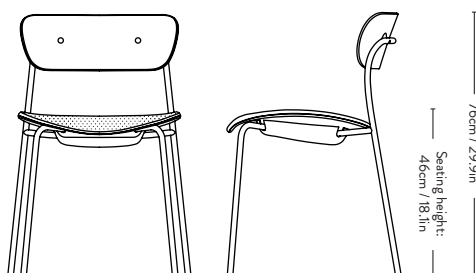

Pavilion ^{AV3} Anderssen & Voll 2018



Item code	Upholstery	Model	Base	Finish	Lead time	Weight	PRICE EX. VAT (SEK)	PRICE INC. VAT (SEK)
Leather	Tailor Semi-aniline leather	AV3	Black	Black or Oak	6-8 weeks	8.00 kg	4.532	5.665
		AV3	Black	Walnut	6-8 weeks	8.00 kg	4.772	5.965
		AV3	Chrome	Black or Oak	6-8 weeks	8.00 kg	4.888	6.110
		AV3	Chrome	Walnut	6-8 weeks	8.00 kg	4.652	5.815
Leather	Noble Aniline leather	AV3	Black	Black or Oak	6-8 weeks	8.00 kg	4.772	5.965
		AV3	Black	Walnut	6-8 weeks	8.00 kg	5.008	6.260
		AV3	Chrome	Black or Oak	6-8 weeks	8.00 kg	5.128	6.410
		AV3	Chrome	Walnut	6-8 weeks	8.00 kg	4.888	6.110
Leather	Elmosoft Semi-aniline leather	AV3	Black	Black or Oak	6-8 weeks	8.00 kg	5.128	6.410
		AV3	Black	Walnut	6-8 weeks	8.00 kg	5.368	6.710
		AV3	Chrome	Black or Oak	6-8 weeks	8.00 kg	5.488	6.860
		AV3	Chrome	Walnut	6-8 weeks	8.00 kg	5.248	6.560
Fabric COM	COM Fabric	AV3	Black	Black or Oak	6-8 weeks	8.00 kg	3.576	4.470
		AV3	Black	Walnut	6-8 weeks	8.00 kg	3.816	4.770
		AV3	Chrome	Black or Oak	6-8 weeks	8.00 kg	3.936	4.920
		AV3	Chrome	Walnut	6-8 weeks	8.00 kg	3.696	4.620

Item code	Product	Lead time	Weight	PRICE EX. VAT (SEK)	PRICE INC. VAT (SEK)
50099990	Pavilion Stacking Trolley	Stock item	20.00 kg	9.548	11.935
50010001	Pavilion chair hanger *can only be used for AV1, AV3 & AV12	6-8 weeks		232	290



EU Ecolabel certified, validating high standards of durability, circular design, and responsible use of chemicals. Please contact our sales team for a list of EU Ecolabel compliant combinations.

Frame	Back
Black	Water based Lacquered Oak, Black Water Based Lacquered Oak, Water based Lacquered Walnut
Chrome	Water based Lacquered Oak, Black Water Based Lacquered Oak, Water based Lacquered Walnut

Material: Steel tubes, formpressed veneer, HR foam, fabric or leather upholstery.

Fabric usage: 0.45 meters based on 140cm roll.

Leather usage: 0.55 square meters based on a yield of 60% pr hide.

COM must be approved by &Tradition to ensure suitability for upholstery.

Plastic gliders installed as standard. Felt gliders available upon request.

Black base: Black fittings for the front side of the back rest installed as standard. Brass & Chrome fittings available upon request.

Chrome base: Chrome fittings for the front side of the back rest installed as standard. Brass & Black fittings available upon request.

Stackable chair.
With trolley: 10 pcs / Without trolley: 8 pcs

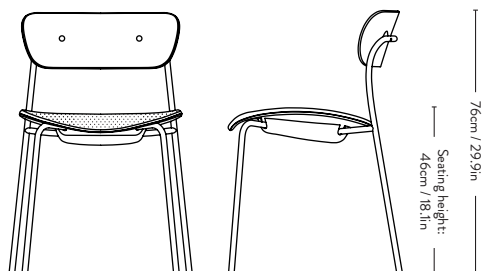

Pavilion ^{AV4} Anderssen & Voll 2018



Price group	Upholstery	Model	Base	Finish	Lead time	Weight	PRICE EX. VAT (SEK)	PRICE INC. VAT (SEK)
Fabric gr. 1	Hot Madison, Remix, Re-Wool	AV4	Black	Black or Oak	6-8 weeks	9.00 kg	4.172	5.215
		AV4	Black	Walnut	6-8 weeks	9.00 kg	4.292	5.365
		AV4	Chrome	Black or Oak	6-8 weeks	9.00 kg	4.532	5.665
		AV4	Chrome	Walnut	6-8 weeks	9.00 kg	4.652	5.815
Fabric gr. 2	Canvas, Barnum, Fiord, Ritz	AV4	Black	Black or Oak	6-8 weeks	9.00 kg	4.772	5.965
		AV4	Black	Walnut	6-8 weeks	9.00 kg	4.888	6.110
		AV4	Chrome	Black or Oak	6-8 weeks	9.00 kg	5.128	6.410
		AV4	Chrome	Walnut	6-8 weeks	9.00 kg	5.248	6.560
Fabric gr. 3	Clay, Hallingdal, Steelcut Quartet, Steelcut Trio	AV4	Black	Black or Oak	6-8 weeks	9.00 kg	4.828	6.035
		AV4	Black	Walnut	6-8 weeks	9.00 kg	4.948	6.185
		AV4	Chrome	Black or Oak	6-8 weeks	9.00 kg	5.188	6.485
		AV4	Chrome	Walnut	6-8 weeks	9.00 kg	5.308	6.635
Fabric gr. 4	Acca, Cifrado, Ecriture, Moss, Uniform Melange, Vidar	AV4	Black	Black or Oak	6-8 weeks	9.00 kg	4.888	6.110
		AV4	Black	Walnut	6-8 weeks	9.00 kg	5.008	6.260
		AV4	Chrome	Black or Oak	6-8 weeks	9.00 kg	5.248	6.560
		AV4	Chrome	Walnut	6-8 weeks	9.00 kg	5.368	6.710
Fabric gr. 5	Karakorum, Sisu	AV4	Black	Black or Oak	6-8 weeks	9.00 kg	5.368	6.710
		AV4	Black	Walnut	6-8 weeks	9.00 kg	5.488	6.860
		AV4	Chrome	Black or Oak	6-8 weeks	9.00 kg	5.724	7.155
		AV4	Chrome	Walnut	6-8 weeks	9.00 kg	5.844	7.305
Fabric gr. 6	Fuse, Gentle	AV4	Black	Black or Oak	6-8 weeks	9.00 kg	5.844	7.305
		AV4	Black	Walnut	6-8 weeks	9.00 kg	5.964	7.455
		AV4	Chrome	Black or Oak	6-8 weeks	9.00 kg	6.324	7.905
		AV4	Chrome	Walnut	6-8 weeks	9.00 kg	6.440	8.050

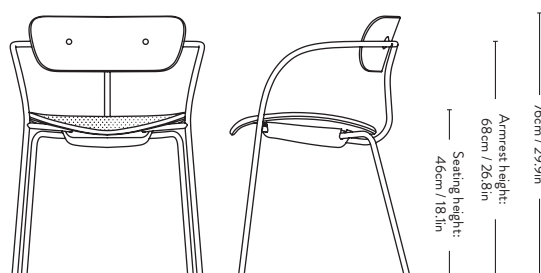

Pavilion AV4 Anderssen & Voll 2018



Item code	Upholstery	Model	Base	Finish	Lead time	Weight	PRICE EX. VAT (SEK)	PRICE INC. VAT (SEK)
Leather	Tailor Semi-aniline leather	AV4	Black	Black or Oak	6-8 weeks	9.00 kg	5.128	6.410
		AV4	Black	Walnut	6-8 weeks	9.00 kg	5.248	6.560
		AV4	Chrome	Black or Oak	6-8 weeks	9.00 kg	5.488	6.860
		AV4	Chrome	Walnut	6-8 weeks	9.00 kg	5.604	7.005
Leather	Noble Aniline leather	AV4	Black	Black or Oak	6-8 weeks	9.00 kg	5.368	6.710
		AV4	Black	Walnut	6-8 weeks	9.00 kg	5.488	6.860
		AV4	Chrome	Black or Oak	6-8 weeks	9.00 kg	5.724	7.155
		AV4	Chrome	Walnut	6-8 weeks	9.00 kg	5.844	7.305
Leather	Elmosoft Semi-aniline leather	AV4	Black	Black or Oak	6-8 weeks	9.00 kg	5.724	7.155
		AV4	Black	Walnut	6-8 weeks	9.00 kg	5.844	7.305
		AV4	Chrome	Black or Oak	6-8 weeks	9.00 kg	6.084	7.605
		AV4	Chrome	Walnut	6-8 weeks	9.00 kg	6.204	7.755
Fabric COM	COM Fabric	AV4	Black	Black or Oak	6-8 weeks	9.00 kg	4.172	5.215
		AV4	Black	Walnut	6-8 weeks	9.00 kg	4.292	5.365
		AV4	Chrome	Black or Oak	6-8 weeks	9.00 kg	4.532	5.665
		AV4	Chrome	Walnut	6-8 weeks	9.00 kg	4.652	5.815

Item code	Product	Lead time	Weight	PRICE EX. VAT (SEK)	PRICE INC. VAT (SEK)
50099990	Pavilion Stacking Trolley	Stock item	20.00 kg	9.548	11.935



EU Ecolabel certified, validating high standards of durability, circular design, and responsible use of chemicals. Please contact our sales team for a list of EU Ecolabel compliant combinations.

Frame	Back
Black	Water based Lacquered Oak, Black Water Based Lacquered Oak, Water based Lacquered Walnut
Chrome	Water based Lacquered Oak, Black Water Based Lacquered Oak, Water based Lacquered Walnut

Material: Steel tubes, formpressed veneer, HR foam, fabric or leather upholstery.

Fabric usage: 0.45 meters based on 140cm roll.

Leather usage: 0.55 square meters based on a yield of 60% pr hide.

COM must be approved by &Tradition to ensure suitability for upholstery.

Plastic gliders installed as standard. Felt gliders available upon request.

Black base: Black fittings for the front side of the back rest installed as standard. Brass & Chrome fittings available upon request.

Chrome base: Chrome fittings for the front side of the back rest installed as standard. Brass & Black fittings available upon request.

Stackable chair.

With trolley: 10 pcs / Without trolley: 8 pcs

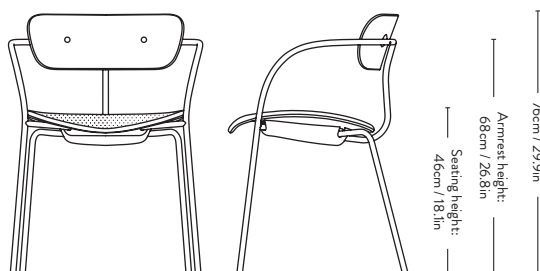

Pavilion ^{AV12} Anderssen & Voll 2019



Price group	Upholstery	Model	Base	Lead time	Weight	PRICE EX. VAT (SEK)	PRICE INC. VAT (SEK)
Fabric gr. 1	Hot Madison, Remix, Re-Wool	AV12	Black	6-8 weeks	9.00 kg	4.532	5.665
		AV12	Chrome	6-8 weeks	9.00 kg	4.772	5.965
Fabric gr. 2	Canvas, Barnum, Fiord, Ritz	AV12	Black	6-8 weeks	9.00 kg	5.724	7.155
		AV12	Chrome	6-8 weeks	9.00 kg	5.964	7.455
Fabric gr. 3	Clay, Hallingdal, Steelcut Quartet, Steelcut Trio	AV12	Black	6-8 weeks	9.00 kg	5.844	7.305
		AV12	Chrome	6-8 weeks	9.00 kg	6.084	7.605
Fabric gr. 4	Acca, Cifrado, Ecriture, Moss, Uniform Melange, Vidar	AV12	Black	6-8 weeks	9.00 kg	5.964	7.455
		AV12	Chrome	6-8 weeks	9.00 kg	6.204	7.755
Fabric gr. 5	Karakorum, Sisu	AV12	Black	6-8 weeks	9.00 kg	6.920	8.650
		AV12	Chrome	6-8 weeks	9.00 kg	7.160	8.950
Fabric gr. 6	Fuse, Gentle	AV12	Black	6-8 weeks	9.00 kg	7.756	9.695
		AV12	Chrome	6-8 weeks	9.00 kg	7.876	9.845
Fabric COM	COM Fabric	AV12	Black	6-8 weeks	9.00 kg	4.532	5.665
		AV12	Chrome	6-8 weeks	9.00 kg	4.772	5.965

Item code	Product	Lead time	Weight	PRICE EX. VAT (SEK)	PRICE INC. VAT (SEK)
50099990	Pavilion Stacking Trolley	Stock item	20.00 kg	9.548	11.935
50010001	Pavilion chair hanger *can only be used for AV1, AV3 & AV12	6-8 weeks		232	290



EU Ecolabel certified, validating high standards of durability, circular design, and responsible use of chemicals. Please contact our sales team for a list of EU Ecolabel compliant combinations.

Frame	Back	Seat
Black	Upholstered	Upholstered
Chrome	Upholstered	Upholstered

Material: Steel tubes, formpressed veneer, HR foam, fabric upholstery.

Fabric usage: 0.9 meter based on a 140cm roll.

COM must be approved by &Tradition to ensure suitability for upholstery.

Pavilion AV12 is not available in leather.

Plastic gliders installed as standard. Felt gliders available upon request.

Stackable chair.

With trolley: 10 pcs / Without trolley: 8 pcs

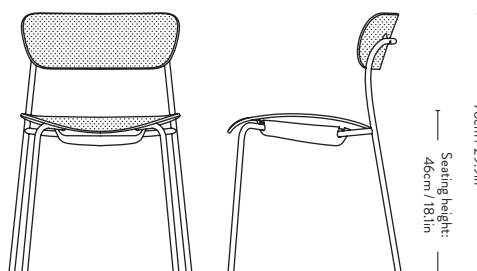

Pavilion ^{AV13} Anderssen & Voll 2019



Price group	Upholstery	Model	Base	Lead time	Weight	PRICE EX. VAT (SEK)	PRICE INC. VAT (SEK)
Fabric gr. 1	Hot Madison, Remix, Re-Wool	AV13	Black	6-8 weeks	9.00 kg	5.128	6.410
		AV13	Chrome	6-8 weeks	9.00 kg	5.488	6.860
Fabric gr. 2	Canvas, Barnum, Fiord, Ritz	AV13	Black	6-8 weeks	9.00 kg	6.324	7.905
		AV13	Chrome	6-8 weeks	9.00 kg	6.680	8.350
Fabric gr. 3	Clay, Hallingdal, Steelcut Quartet, Steelcut Trio	AV13	Black	6-8 weeks	9.00 kg	6.440	8.050
		AV13	Chrome	6-8 weeks	9.00 kg	6.800	8.500
Fabric gr. 4	Acca, Cifrado, Ecriture, Moss, Uniform Melange, Vidar	AV13	Black	6-8 weeks	9.00 kg	6.560	8.200
		AV13	Chrome	6-8 weeks	9.00 kg	6.920	8.650
Fabric gr. 5	Karakorum, Sisu	AV13	Black	6-8 weeks	9.00 kg	7.516	9.395
		AV13	Chrome	6-8 weeks	9.00 kg	7.876	9.845
Fabric gr. 6	Fuse, Gentle	AV13	Black	6-8 weeks	9.00 kg	8.232	10.290
		AV13	Chrome	6-8 weeks	9.00 kg	8.712	10.890
Fabric COM	COM Fabric	AV13	Black	6-8 weeks	9.00 kg	5.128	6.410
		AV13	Chrome	6-8 weeks	9.00 kg	5.488	6.860

Item code	Product	Lead time	Weight	PRICE EX. VAT (SEK)	PRICE INC. VAT (SEK)
50099990	Pavilion Stacking Trolley	Stock item	20.00 kg	9.548	11.935



EU Ecolabel certified, validating high standards of durability, circular design, and responsible use of chemicals. Please contact our sales team for a list of EU Ecolabel compliant combinations.

Frame	Back	Seat
Black	Upholstered	Upholstered

Material: Steel tubes, formpressed veneer, HR foam, fabric upholstery.

Fabric usage: 0.9 meter based on a 140cm roll.

COM must be approved by &Tradition to ensure suitability for upholstery.

Pavilion AV13 is not available in leather.

Plastic gliders installed as standard. Felt gliders available upon request.

Stackable chair.

With trolley: 10 pcs / Without trolley: 8 pcs

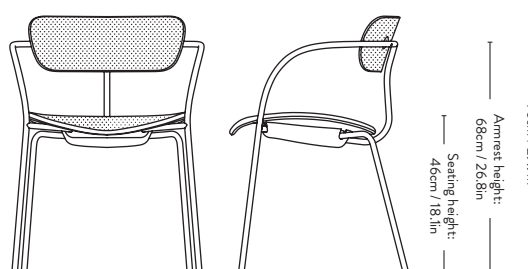

Pavilion ^{AV5} Anderssen & Voll 2018



Item code	Base	Model	Finish	Colli qty.	Lead time	Weight	PRICE EX. VAT (SEK)	PRICE INC. VAT (SEK)
50030192	Black	AV5	Oak	1 pc	6-8 weeks	5.50 kg	5.488	6.860
		AV5	Black Oak	1 pc	6-8 weeks	5.50 kg	5.488	6.860
50030196	Black	AV5	Walnut	1 pc	6-8 weeks	5.50 kg	5.844	7.305



EU Ecolabel certified, validating high standards of durability, circular design, and responsible use of chemicals. Please contact our sales team for a list of EU Ecolabel compliant combinations.

Frame Seat & back

Black Water Based Lacquered Oak, Black Water Based Lacquered Oak, Water based Lacquered Walnut

Material: Steel tubes and formpressed veneer.

Plastic gliders installed as standard.
Felt gliders available upon request.

Black fittings for the front side of the back rest installed as standard.
Brass fittings available upon request (6-8 weeks lead time).

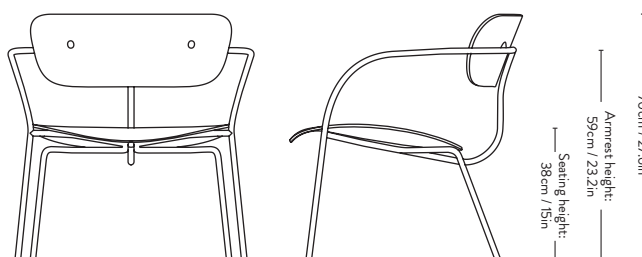

Pavilion ^{AV6} Anderssen & Voll 2018



Item code	Upholstery	Model	Finish	Lead time	Weight	PRICE EX. VAT (SEK)	PRICE INC. VAT (SEK)
Fabric gr. 1	Hot Madison, Remix, Re-Wool	AV6	Black Oak	6-8 weeks	6.50 kg	6.560	8.200
		AV6	Oak	6-8 weeks	6.50 kg	6.560	8.200
		AV6	Walnut	6-8 weeks	6.50 kg	6.920	8.650
Fabric gr. 2	Canvas, Barnum, Fiord, Ritz	AV6	Black Oak	6-8 weeks	6.50 kg	7.276	9.095
		AV6	Oak	6-8 weeks	6.50 kg	7.276	9.095
		AV6	Walnut	6-8 weeks	6.50 kg	7.636	9.545
Fabric gr. 3	Clay, Hallingdal, Steelcut Quartet, Steelcut Trio	AV6	Black Oak	6-8 weeks	6.50 kg	7.336	9.170
		AV6	Oak	6-8 weeks	6.50 kg	7.336	9.170
		AV6	Walnut	6-8 weeks	6.50 kg	7.696	9.620
Fabric gr. 4	Acca, Cifrado, Ecriture, Moss, Uniform Melange, Vidar	AV6	Black Oak	6-8 weeks	6.50 kg	7.516	9.395
		AV6	Oak	6-8 weeks	6.50 kg	7.516	9.395
		AV6	Walnut	6-8 weeks	6.50 kg	7.756	9.695
Fabric gr. 5	Karakorum, Sisu	AV6	Black Oak	6-8 weeks	6.50 kg	7.996	9.995
		AV6	Oak	6-8 weeks	6.50 kg	7.996	9.995
		AV6	Walnut	6-8 weeks	6.50 kg	8.232	10.290
Fabric gr. 6	Fuse, Gentle	AV6	Black Oak	6-8 weeks	6.50 kg	8.828	11.035
		AV6	Oak	6-8 weeks	6.50 kg	8.828	11.035
		AV6	Walnut	6-8 weeks	6.50 kg	9.068	11.335
Leather	Tailor Semi-aniline leather	AV6	Black Oak	6-8 weeks	6.50 kg	7.756	9.695
		AV6	Oak	6-8 weeks	6.50 kg	7.756	9.695
		AV6	Walnut	6-8 weeks	6.50 kg	7.996	9.995
Leather	Noble Aniline leather	AV6	Black Oak	6-8 weeks	6.50 kg	7.996	9.995
		AV6	Oak	6-8 weeks	6.50 kg	7.996	9.995
		AV6	Walnut	6-8 weeks	6.50 kg	8.232	10.290
Leather	Elmosoft Semi-aniline leather	AV6	Black Oak	6-8 weeks	6.50 kg	8.352	10.440
		AV6	Oak	6-8 weeks	6.50 kg	8.352	10.440
		AV6	Walnut	6-8 weeks	6.50 kg	8.592	10.740
Fabric COM	COM Fabric	AV6	Black Oak	6-8 weeks	6.50 kg	6.560	8.200
		AV6	Oak	6-8 weeks	6.50 kg	6.560	8.200
		AV6	Walnut	6-8 weeks	6.50 kg	6.920	8.650

Frame	Back	Seat
Black	Water Based Lacquered Oak, Black Water Based Lacquered Oak, Water based Lacquered Walnut	Upholstered

Material: Steel tubes, formpressed veneer, HR foam, fabric or leather upholstery.

Fabric usage: 0.73 meters based on 140cm roll

Leather usage: 0.5 square meters based on a yield of 60% pr hide.

COM must be approved by &Tradition to ensure suitability for upholstery.

Plastic gliders installed as standard. Felt gliders available upon request. Black fittings for the front side of the back rest installed as standard. Brass fittings available upon request (6-8 weeks lead time).



EU Ecolabel certified, validating high standards of durability, circular design, and responsible use of chemicals. Please contact our sales team for a list of EU Ecolabel compliant combinations.

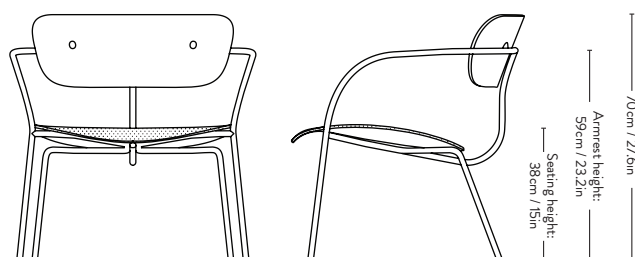

Pavilion ^{AV11} Anderssen & Voll 2019



Price group	Upholstery	Model	Lead time	Weight	PRICE EX. VAT (SEK)	PRICE INC. VAT (SEK)
Fabric gr. 1	Hot Madison, Remix, Re-Wool	AV11	6-8 weeks	6.50 kg	7.516	9.395
Fabric gr. 2	Canvas, Barnum, Fiord, Ritz	AV11	6-8 weeks	6.50 kg	8.232	10.290
Fabric gr. 3	Clay, Hallingdal, Steelcut Quartet, Steelcut Trio	AV11	6-8 weeks	6.50 kg	8.352	10.440
Fabric gr. 4	Acca, Cifrado, Ecriture, Moss, Uniform Melange, Vidar	AV11	6-8 weeks	6.50 kg	8.472	10.590
Fabric gr. 5	Karakorum, Sisu	AV11	6-8 weeks	6.50 kg	8.948	11.185
Fabric gr. 6	Fuse, Gentle	AV11	6-8 weeks	6.50 kg	9.784	12.230
Fabric COM	COM Fabric	AV11	6-8 weeks	6.50 kg	7.516	9.395



EU Ecolabel certified, validating high standards of durability, circular design, and responsible use of chemicals. Please contact our sales team for a list of EU Ecolabel compliant combinations.

Frame	Back	Seat
Black	Upholstered	Upholstered

Material: Steel tubes, formpressed veneer, HR foam, fabric or leather upholstery.

Fabric usage: 1 meter based on a 140cm roll.

COM must be approved by &Tradition to ensure suitability for upholstery.

Pavilion AV11 is not available in leather.

Plastic gliders installed as standard.
Felt gliders available upon request.

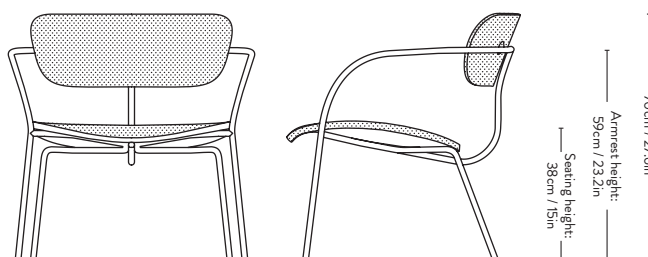

Pavilion ^{AV7} Anderssen & Voll 2018

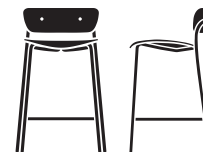

Item code	Product	Model	Colli qty.	Lead time	Weight	PRICE EX. VAT (SEK)	PRICE INC. VAT (SEK)
50060092	Oak	AV7	1 pc	Stock item	5.00 kg	4.052	5.065
50060094	Black Oak	AV7	1 pc	Stock item	5.00 kg	4.052	5.065
50060096	Walnut	AV7	1 pc	Stock item	5.00 kg	4.172	5.215



EU Ecolabel certified, validating high standards of durability, circular design, and responsible use of chemicals. Please contact our sales team for a list of EU Ecolabel compliant combinations.

Frame	Seat & back
Black	Water Based Lacquered Oak, Black Water Based Lacquered Oak, Water based Lacquered Walnut

Material: Steel tubes, formpressed veneer

Plastic gliders installed as standard. Felt gliders available upon request.

Black fittings for the front side of the back rest installed as standard. Brass fittings available upon request.

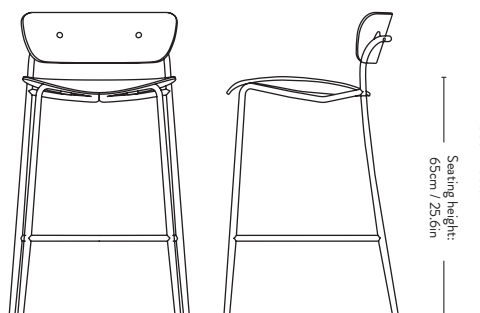

Pavilion AV8 Anderssen & Voll 2018



Price group	Upholstery	Model	Finish	Lead time	Weight	PRICE EX. VAT (SEK)	PRICE INC. VAT (SEK)
Fabric gr. 1	Hot Madison, Remix, Re-Wool	AV8	Black Oak	6-8 weeks	5.50 kg	4.888	6.110
		AV8	Oak	6-8 weeks	5.50 kg	4.888	6.110
		AV8	Walnut	6-8 weeks	5.50 kg	5.008	6.260
Fabric gr. 2	Canvas, Barnum, Fiord, Ritz	AV8	Black Oak	6-8 weeks	5.50 kg	5.488	6.860
		AV8	Oak	6-8 weeks	5.50 kg	5.488	6.860
		AV8	Walnut	6-8 weeks	5.50 kg	5.604	7.005
Fabric gr. 3	Clay, Hallingdal, Steelcut Quartet, Steelcut Trio	AV8	Black Oak	6-8 weeks	5.50 kg	5.548	6.935
		AV8	Oak	6-8 weeks	5.50 kg	5.548	6.935
		AV8	Walnut	6-8 weeks	5.50 kg	5.664	7.080
Fabric gr. 4	Acca, Cifrado, Ecriture, Moss, Uniform Melange, Vidar	AV8	Black Oak	6-8 weeks	5.50 kg	5.604	7.005
		AV8	Oak	6-8 weeks	5.50 kg	5.604	7.005
		AV8	Walnut	6-8 weeks	5.50 kg	5.724	7.155
Fabric gr. 5	Karakorum, Sisu	AV8	Black Oak	6-8 weeks	5.50 kg	6.084	7.605
		AV8	Oak	6-8 weeks	5.50 kg	6.084	7.605
		AV8	Walnut	6-8 weeks	5.50 kg	6.204	7.755
Fabric gr. 6	Fuse, Gentle	AV8	Black Oak	6-8 weeks	5.50 kg	6.680	8.350
		AV8	Oak	6-8 weeks	5.50 kg	6.680	8.350
		AV8	Walnut	6-8 weeks	5.50 kg	6.800	8.500
Leather	Tailor Semi-aniline leather	AV8	Black Oak	6-8 weeks	5.50 kg	5.844	7.305
		AV8	Oak	6-8 weeks	5.50 kg	5.844	7.305
		AV8	Walnut	6-8 weeks	5.50 kg	5.964	7.455
Leather	Noble Aniline leather	AV8	Black Oak	6-8 weeks	5.50 kg	6.084	7.605
		AV8	Oak	6-8 weeks	5.50 kg	6.084	7.605
		AV8	Walnut	6-8 weeks	5.50 kg	6.204	7.755
Leather	Elmosoft Semi-aniline leather	AV8	Black Oak	6-8 weeks	5.50 kg	6.440	8.050
		AV8	Oak	6-8 weeks	5.50 kg	6.440	8.050
		AV8	Walnut	6-8 weeks	5.50 kg	6.560	8.200
Fabric COM	COM Fabric	AV8	Black Oak	6-8 weeks	5.50 kg	4.888	6.110
		AV8	Oak	6-8 weeks	5.50 kg	4.888	6.110
		AV8	Walnut	6-8 weeks	5.50 kg	5.008	6.260

Frame	Back
Black	Water Based Lacquered Oak, Black Water Based Lacquered Oak, Water based Lacquered Walnut

Material: Steel tubes, formpressed veneer, HR foam, fabric or leather upholstery.

Fabric usage (Pavilion AV8): 0.45 meters based on 140cm roll.

Leather usage (Pavilion AV8): 0.55 square meters based on a yield of 60% pr hide.

COM must be approved by &Tradition to ensure suitability for upholstery. Plastic gliders installed as standard. Felt gliders available upon request.

Black fittings for the front side of the back rest installed as standard. Brass fittings available upon request.



EU Ecolabel certified, validating high standards of durability, circular design, and responsible use of chemicals. Please contact our sales team for a list of EU Ecolabel compliant combinations.

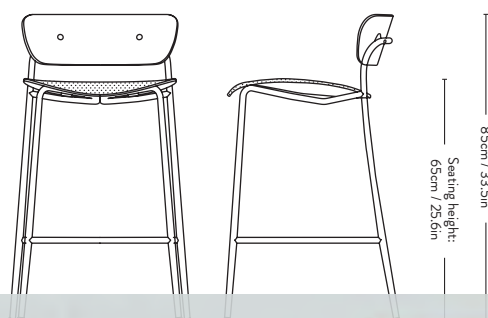

Pavilion ^{AV14} Anderssen & Voll 2019



Price group	Upholstery	Model	Lead time	Weight	PRICE EX. VAT (SEK)	PRICE INC. VAT (SEK)
Fabric gr. 1	Hot Madison, Remix, Re-Wool	AV14	6-8 weeks	5.50 kg	5.844	7.305
Fabric gr. 2	Canvas, Barnum, Fiord, Ritz	AV14	6-8 weeks	5.50 kg	7.040	8.800
Fabric gr. 3	Clay, Hallingdal, Steelcut Quartet, Steelcut Trio	AV14	6-8 weeks	5.50 kg	7.160	8.950
Fabric gr. 4	Acca, Cifrado, Ecriture, Moss, Uniform Melange, Vidar	AV14	6-8 weeks	5.50 kg	7.276	9.095
Fabric gr. 5	Karakorum, Sisu	AV14	6-8 weeks	5.50 kg	8.232	10.290
Fabric gr. 6	Fuse, Gentle	AV14	6-8 weeks	5.50 kg	9.068	11.335
Fabric COM	COM Fabric	AV14	6-8 weeks	5.50 kg	5.844	7.305

Frame	Back	Seat
Black	Upholstered	Upholstered

Material: Steel tubes, formpressed veneer, HR foam, fabric or leather upholstery.

Fabric usage: 0.8 meter based on a 140cm roll.

COM must be approved by &Tradition to ensure suitability for upholstery.

Pavilion AV14 is not available in leather.

Plastic gliders installed as standard.

Felt gliders available upon request.



EU Ecolabel certified, validating high standards of durability, circular design, and responsible use of chemicals. Please contact our sales team for a list of EU Ecolabel compliant combinations.

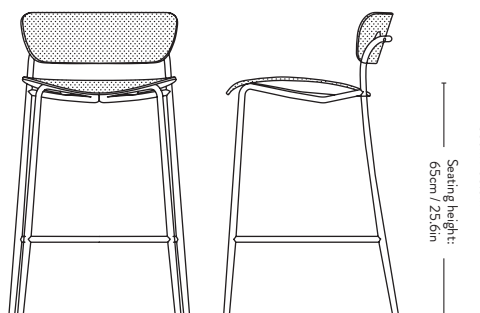

Pavilion ^{AV9} Anderssen & Voll 2018



Item code	Product	Model	Colli qty.	Lead time	Weight	PRICE EX. VAT (SEK)	PRICE INC. VAT (SEK)
50090092	Oak	AV9	1 pc	Stock item	5.30 kg	4.172	5.215
50090094	Black Oak	AV9	1 pc	Stock item	5.30 kg	4.172	5.215
50090096	Walnut	AV9	1 pc	Stock item	5.30 kg	4.292	5.365

Frame Seat & back

Black Water Based Lacquered Oak, Black Water Based Lacquered Oak, Water based Lacquered Walnut

Material: Steel tubes, formpressed veneer.

Plastic gliders installed as standard. Felt gliders available upon request. Black fittings for the front side of the back rest installed as standard. Brass fittings available upon request (6-8 weeks lead time, on AV9 only).



EU Ecolabel certified, validating high standards of durability, circular design, and responsible use of chemicals. Please contact our sales team for a list of EU Ecolabel compliant combinations.

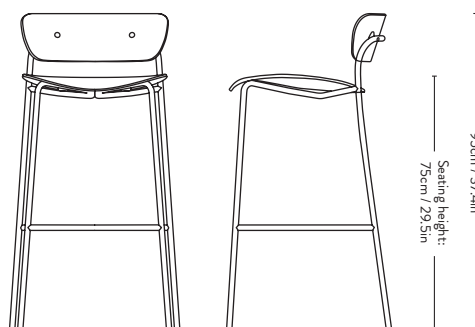

Pavilion ^{AV10} Anderssen & Voll 2018



	Upholstery	Model	Finish	Lead time	Weight	PRICE EX. VAT (SEK)	PRICE INC. VAT (SEK)
Fabric gr. 1	Hot Madison, Remix, Re-Wool	AV10	Black Oak	6-8 weeks	5.80 kg	5.008	6.260
		AV10	Oak	6-8 weeks	5.80 kg	5.008	6.260
		AV10	Walnut	6-8 weeks	5.80 kg	5.128	6.410
Fabric gr. 2	Canvas, Barnum, Fiord, Ritz	AV10	Black Oak	6-8 weeks	5.50 kg	5.604	7.005
		AV10	Oak	6-8 weeks	5.50 kg	5.604	7.005
		AV10	Walnut	6-8 weeks	5.50 kg	5.724	7.155
Fabric gr. 3	Clay, Hallingdal, Steelcut Quartet, Steelcut Trio	AV10	Black Oak	6-8 weeks	5.50 kg	5.664	7.080
		AV10	Oak	6-8 weeks	5.50 kg	5.664	7.080
		AV10	Walnut	6-8 weeks	5.50 kg	5.784	7.230
Fabric gr. 4	Acca, Cifrado, Ecriture, Moss, Uniform Melange, Vidar	AV10	Black Oak	6-8 weeks	5.50 kg	5.724	7.155
		AV10	Oak	6-8 weeks	5.50 kg	5.724	7.155
		AV10	Walnut	6-8 weeks	5.50 kg	5.844	7.305
Fabric gr. 5	Karakorum, Sisu	AV10	Black Oak	6-8 weeks	5.50 kg	6.204	7.755
		AV10	Oak	6-8 weeks	5.50 kg	6.204	7.755
		AV10	Walnut	6-8 weeks	5.50 kg	6.324	7.905
Fabric gr. 6	Fuse, Gentle	AV10	Black Oak	6-8 weeks	5.50 kg	6.800	8.500
		AV10	Oak	6-8 weeks	5.50 kg	6.800	8.500
		AV10	Walnut	6-8 weeks	5.50 kg	6.920	8.650
Leather	Tailor Semi-aniline leather	AV10	Black Oak	6-8 weeks	5.50 kg	5.964	7.455
		AV10	Oak	6-8 weeks	5.50 kg	5.964	7.455
		AV10	Walnut	6-8 weeks	5.50 kg	6.084	7.605
Leather	Noble Aniline leather	AV10	Black Oak	6-8 weeks	5.50 kg	6.204	7.755
		AV10	Oak	6-8 weeks	5.50 kg	6.204	7.755
		AV10	Walnut	6-8 weeks	5.50 kg	6.324	7.905
Leather	Elmosoft Semi-aniline leather	AV10	Black Oak	6-8 weeks	5.50 kg	6.560	8.200
		AV10	Oak	6-8 weeks	5.50 kg	6.560	8.200
		AV10	Walnut	6-8 weeks	5.50 kg	6.680	8.350
Fabric COM	COM Fabric	AV10	Black Oak	6-8 weeks	5.50 kg	5.008	6.260
		AV10	Oak	6-8 weeks	5.50 kg	5.008	6.260
		AV10	Walnut	6-8 weeks	5.50 kg	5.128	6.410

Fabric usage (AV10 only): 0.45 meters based on 140cm roll.

Leather usage (AV10 only): 0.55 square meters based on a yield of 60% pr hide. COM must be approved by &Tradition to ensure suitability for upholstery.



EU Ecolabel certified, validating high standards of durability, circular design, and responsible use of chemicals. Please contact our sales team for a list of EU Ecolabel compliant combinations.

Frame Back

Black Water Based Lacquered Oak, Black Water Based Lacquered Oak, Water based Lacquered Walnut

Material: Steel tubes, formpressed veneer, HR foam, fabric or leather upholstery.

Plastic gliders installed as standard. Felt gliders available upon request. Black fittings for the front side of the back rest installed as standard. Brass fittings available upon request (6-8 weeks lead time, on AV9 only).

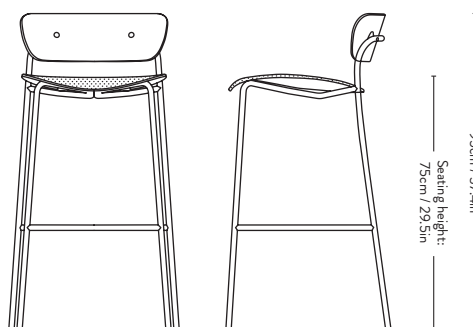

Pavilion ^{AV15} Anderssen & Voll 2019



Price group	Upholstery	Model	Lead time	Weight	PRICE EX. VAT (SEK)	PRICE INC. VAT (SEK)
Fabric gr. 1	Hot Madison, Remix, Re-Wool	AV15	6-8 weeks	5.80 kg	5.964	7.455
Fabric gr. 2	Canvas, Barnum, Fiord, Ritz	AV15	6-8 weeks	5.80 kg	7.160	8.950
Fabric gr. 3	Clay, Hallingdal, Steelcut Quartet, Steelcut Trio	AV15	6-8 weeks	5.80 kg	7.396	9.245
Fabric gr. 4	Acca, Cifrado, Ecriture, Moss, Uniform Melange, Vidar	AV15	6-8 weeks	5.80 kg	7.396	9.245
Fabric gr. 5	Karakorum, Sisu	AV15	6-8 weeks	5.80 kg	8.352	10.440
Fabric gr. 6	Fuse, Gentle	AV15	6-8 weeks	5.80 kg	9.188	11.485
Fabric COM	COM Fabric	AV15	6-8 weeks	5.80 kg	5.964	7.455

Frame	Back	Seat
Black	Upholstered	Upholstered

Material: Steel tubes, formpressed veneer, HR foam, fabric upholstery.

Fabric usage: 0.8 meter based on a 140cm roll.

COM must be approved by &Tradition to ensure suitability for upholstery.

Pavilion AV15 is not available in leather.

Plastic gliders installed as standard.
Felt gliders available upon request.



EU Ecolabel certified, validating high standards of durability, circular design, and responsible use of chemicals. Please contact our sales team for a list of EU Ecolabel compliant combinations.

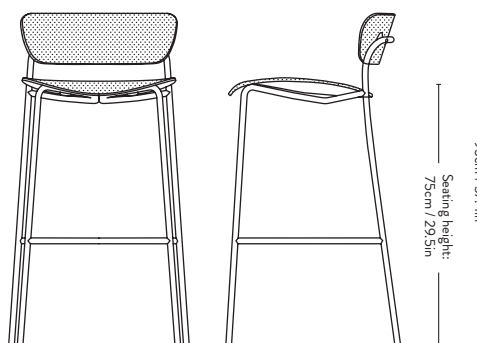

Rely ^{HW6} Hee Welling 2020



Item code	Shell Colour	Model	Base	Colli qty.	Lead time	Weight	PRICE EX. VAT (SEK)	PRICE INC. VAT (SEK)
HW	Black	HW6	Black, Bronzed, Chrome	1 pc 4 pcs	2-3 weeks	5.20 kg	2.264 2.144	2.830 2.680
HW	White	HW6	Black, Bronzed, Chrome	1 pc 4 pcs	2-3 weeks	5.20 kg	2.264 2.144	2.830 2.680
HW	Beige Sand	HW6	Black, Bronzed, Chrome	1 pc 4 pcs	2-3 weeks	5.20 kg	2.264 2.144	2.830 2.680
HW	Red Brown	HW6	Black, Bronzed, Chrome	1 pc 4 pcs	2-3 weeks	5.20 kg	2.264 2.144	2.830 2.680
HW	Light Blue	HW6	Black, Bronzed, Chrome	1 pc 4 pcs	2-3 weeks	5.20 kg	2.264 2.144	2.830 2.680
HW	Stone Grey	HW6	Black, Bronzed, Chrome	1 pc 4 pcs	2-3 weeks	5.20 kg	2.264 2.144	2.830 2.680
HW	Vermilion red	HW6	Black, Bronzed, Chrome	1 pc 4 pcs	2-3 weeks	5.20 kg	2.264 2.144	2.830 2.680
HW	Bronze green	HW6	Black, Bronzed, Chrome	1 pc 4 pcs	2-3 weeks	5.20 kg	2.264 2.144	2.830 2.680
HW	Soft Pink	HW6	Black, Bronzed, Chrome	1 pc 4 pcs	2-3 weeks	5.20 kg	2.264 2.144	2.830 2.680

Material: Shell made from 100% recycled polypropylene with fiber glass and a steel tube base.

Wagner QuickClick Plast gliders are installed as standard.
Wagner QuickClick Felt gliders available upon request.



EU Ecolabel certified, validating high standards of durability, circular design, and responsible use of chemicals. Please contact our sales team for a list of EU Ecolabel compliant combinations.

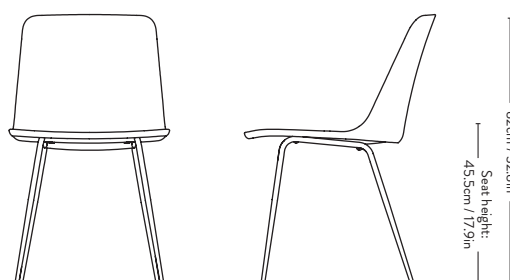

47cm / 18.5in 55cm / 21.6in Seating depth: 46cm / 17.7in

22% RABATT SKA DRAS AV PÅ ANGIVNA PRISER

Rely ^{HW7} Hee Welling 2020



Price group	Shell Colour	Seat Cushion Upholstery	Model	Base	Lead time	Weight	PRICE EX. VAT (SEK)	PRICE INC. VAT (SEK)
Fabric gr. 1	Black, White, Beige Sand, Red Brown, Light Blue, Stone Grey, Vermilion red, Bronze green, Soft Pink	Hot Madison, Remix, Re-Wool	HW7	Black, Bronzed, Chrome	3-6 weeks	6.50 kg	3.576	4.470
Fabric gr. 2	Black, White, Beige Sand, Red Brown, Light Blue, Stone Grey, Vermilion red, Bronze green, Soft Pink	Canvas, Barnum, Fiord, Ritz	HW7	Black, Bronzed, Chrome	3-6 weeks	6.50 kg	3.936	4.920
Fabric gr. 3	Black, White, Beige Sand, Red Brown, Light Blue, Stone Grey, Vermilion red, Bronze green, Soft Pink	Clay, Hallingdal, Steelcut Quartet, Steelcut Trio	HW7	Black, Bronzed, Chrome	3-6 weeks	6.50 kg	4.052	5.065
Fabric gr. 4	Black, White, Beige Sand, Red Brown, Light Blue, Stone Grey, Vermilion red, Bronze green, Soft Pink	Acca, Cifrado, Ecriture, Moss, Uniform Melange, Vidar	HW7	Black, Bronzed, Chrome	3-6 weeks	6.50 kg	4.412	5.515
Fabric gr. 5	Black, White, Beige Sand, Red Brown, Light Blue, Stone Grey, Vermilion red, Bronze green, Soft Pink	Karakorum, Sisu	HW7	Black, Bronzed, Chrome	3-6 weeks	6.50 kg	4.888	6.110
Fabric gr. 6	Black, White, Beige Sand, Red Brown, Light Blue, Stone Grey, Vermilion red, Bronze green, Soft Pink	Fuse, Gentle	HW7	Black, Bronzed, Chrome	3-6 weeks	6.50 kg	5.368	6.710
Leather	Black, White, Beige Sand, Red Brown, Light Blue, Stone Grey, Vermilion red, Bronze green, Soft Pink	Tailor Semi-aniline leather	HW7	Black, Bronzed, Chrome	3-6 weeks	6.50 kg	4.052	5.065
Leather	Black, White, Beige Sand, Red Brown, Light Blue, Stone Grey, Vermilion red, Bronze green, Soft Pink	Noble Aniline leather	HW7	Black, Bronzed, Chrome	3-6 weeks	6.50 kg	4.412	5.515
Leather	Black, White, Beige Sand, Red Brown, Light Blue, Stone Grey, Vermilion red, Bronze green, Soft Pink	Elmosoft Semi-aniline leather	HW7	Black, Bronzed, Chrome	3-6 weeks	6.50 kg	4.772	5.965
Fabric COM	Black, White, Beige Sand, Red Brown, Light Blue, Stone Grey, Vermilion red, Bronze green, Soft Pink	COM Fabric	HW7	Black, Bronzed, Chrome	3-6 weeks	6.50 kg	3.576	4.470



EU Ecolabel certified, validating high standards of durability, circular design, and responsible use of chemicals. Please contact our sales team for a list of EU Ecolabel compliant combinations.

Material: Shell made from 100% recycled polypropylene with fiber glass, HR foam seat covered with fabric or leather upholstery, steel tube base.

Fabric usage: 0.49 meter based on a 140 cm roll.

Leather usage: 1 square meter based on a yield of 60% pr hide.

COM must be approved by &Tradition to ensure suitability for upholstery.

Wagner QuickClick Plast gliders are installed as standard.

Wagner QuickClick Felt gliders available upon request.



Rely ^{HW8} Hee Welling 2020



Price group	Upholstery	Model	Base	Lead time	Weight	PRICE EX. VAT (SEK)	PRICE INC. VAT (SEK)
Fabric gr. 1	Hot Madison, Remix, Re-Wool	HW8	Black, Bronzed, Chrome	3-6 weeks	5.70 kg	4.532	5.665
Fabric gr. 2	Canvas, Barnum, Fiord, Ritz	HW8	Black, Bronzed, Chrome	3-6 weeks	5.70 kg	5.248	6.560
Fabric gr. 3	Clay, Hallingdal, Steelcut Quartet, Steelcut Trio	HW8	Black, Bronzed, Chrome	3-6 weeks	5.70 kg	5.488	6.860
Fabric gr. 4	Acca, Cifrado, Ecriture, Moss, Uniform Melange, Vidar	HW8	Black, Bronzed, Chrome	3-6 weeks	5.70 kg	6.084	7.605
Fabric gr. 5	Karakorum, Sisu	HW8	Black, Bronzed, Chrome	3-6 weeks	5.70 kg	7.516	9.395
Fabric gr. 6	Fuse, Gentle	HW8	Black, Bronzed, Chrome	3-6 weeks	5.70 kg	8.232	10.290
Leather	Tailor Semi-aniline leather	HW8	Black, Bronzed, Chrome	3-6 weeks	5.70 kg	6.440	8.050
Leather	Noble Aniline leather	HW8	Black, Bronzed, Chrome	3-6 weeks	5.70 kg	6.800	8.500
Leather	Elmosoft Semi-aniline leather	HW8	Black, Bronzed, Chrome	3-6 weeks	5.70 kg	7.396	9.245
Fabric COM	COM Fabric	HW8	Black, Bronzed, Chrome	3-6 weeks	5.70 kg	4.532	5.665

Material: Shell made from 100% recycled polypropylene with fiber glass, covered with HR foam with fabric or leather upholstery, steel tube base.

Fabric usage: 1.40 meters based on a 140cm roll.

Leather usage: 2.2 square meters based on a yield of 60% pr hide.

COM must be approved by &Tradition to ensure suitability for upholstery.

Wagner QuickClick Plast gliders are installed as standard.

Wagner QuickClick Felt gliders available upon request.



EU Ecolabel certified, validating high standards of durability, circular design, and responsible use of chemicals.

Please contact our sales team for a list of EU Ecolabel compliant combinations.

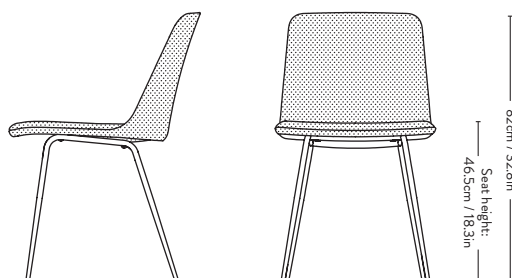

Rely ^{HW9} Hee Welling 2020



Price group	Upholstery	Model	Base	Lead time	Weight	PRICE EX. VAT (SEK)	PRICE INC. VAT (SEK)
Fabric gr. 1	Hot Madison, Remix, Re-Wool	HW9	Black, Bronzed, Chrome	3-6 weeks	6.80 kg	4.772	5.965
Fabric gr. 2	Canvas, Barnum, Fiord, Ritz	HW9	Black, Bronzed, Chrome	3-6 weeks	6.80 kg	5.488	6.860
Fabric gr. 3	Clay, Hallingdal, Steelcut Quartet, Steelcut Trio	HW9	Black, Bronzed, Chrome	3-6 weeks	6.80 kg	5.724	7.155
Fabric gr. 4	Acca, Cifrado, Ecriture, Moss, Uniform Melange, Vidar	HW9	Black, Bronzed, Chrome	3-6 weeks	6.80 kg	6.324	7.905
Fabric gr. 5	Karakorum, Sisu	HW9	Black, Bronzed, Chrome	3-6 weeks	6.80 kg	7.756	9.695
Fabric gr. 6	Fuse, Gentle	HW9	Black, Bronzed, Chrome	3-6 weeks	6.80 kg	8.472	10.590
Leather	Tailor Semi-aniline leather	HW9	Black, Bronzed, Chrome	3-6 weeks	6.80 kg	6.680	8.350
Leather	Noble Aniline leather	HW9	Black, Bronzed, Chrome	3-6 weeks	6.80 kg	7.040	8.800
Leather	Elmosoft Semi-aniline leather	HW9	Black, Bronzed, Chrome	3-6 weeks	6.80 kg	7.756	9.695
Fabric COM	COM Fabric	HW9	Black, Bronzed, Chrome	3-6 weeks	6.80 kg	4.772	5.965

Material: Shell made from 100% recycled polypropylene with fiber glass, covered with HR foam with fabric or leather upholstery, steel tube base.

Fabric usage: 1.8 meters based on a 140cm roll.

Leather usage: 2.7 square meters based on a yield of 60% pr hide.

COM must be approved by &Tradition to ensure suitability for upholstery.

Wagner QuickClick Plast gliders are installed as standard.

Wagner QuickClick Felt gliders available upon request.



EU Ecolabel certified, validating high standards of durability, circular design, and responsible use of chemicals.

Please contact our sales team for a list of EU Ecolabel compliant combinations.

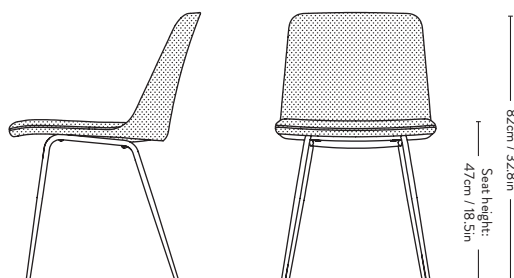

Rely^{HW10} Hee Welling 2020



Please note that price is accumulated price of shell & seat.

Price group	Shell Upholstery	Model	Base	Lead time	Weight	PRICE EX. VAT (SEK)	PRICE INC. VAT (SEK)
Fabric gr. 1	Hot Madison, Remix, Re-Wool	HW10	Black, Bronzed, Chrome	3-6 weeks	6.80 kg	3.580	4.475
Fabric gr. 2	Canvas, Barnum, Fiord, Ritz	HW10	Black, Bronzed, Chrome	3-6 weeks	6.80 kg	3.940	4.925
Fabric gr. 3	Clay, Hallingdal, Steelcut Quartet, Steelcut Trio	HW10	Black, Bronzed, Chrome	3-6 weeks	6.80 kg	4.060	5.075
Fabric gr. 4	Acca, Cifrado, Ecriture, Moss, Uniform Melange, Vidar	HW10	Black, Bronzed, Chrome	3-6 weeks	6.80 kg	4.296	5.370
Fabric gr. 5	Karakorum, Sisu	HW10	Black, Bronzed, Chrome	3-6 weeks	6.80 kg	5.256	6.570
Fabric gr. 6	Fuse, Gentle	HW10	Black, Bronzed, Chrome	3-6 weeks	6.80 kg	5.732	7.165
Leather	Tailor Semi-aniline leather	HW10	Black, Bronzed, Chrome	3-6 weeks	6.80 kg	4.768	5.960
Leather	Noble Aniline leather	HW10	Black, Bronzed, Chrome	3-6 weeks	6.80 kg	5.012	6.265
Leather	Elmosoft Semi-aniline leather	HW10	Black, Bronzed, Chrome	3-6 weeks	6.80 kg	5.256	6.570
Fabric COM	COM Fabric	HW10	Black, Bronzed, Chrome	3-6 weeks	6.80 kg	3.580	4.475

Price group	Seat Upholstery	Lead time	PRICE EX. VAT (SEK)	PRICE INC. VAT (SEK)
Fabric gr. 1	Hot Madison, Remix, Re-Wool	3-6 weeks	1.196	1.495
Fabric gr. 2	Canvas, Barnum, Fiord, Ritz	3-6 weeks	1.556	1.945
Fabric gr. 3	Clay, Hallingdal, Steelcut Quartet, Steelcut Trio	3-6 weeks	1.676	2.095
Fabric gr. 4	Acca, Cifrado, Ecriture, Moss, Uniform Melange, Vidar	3-6 weeks	2.032	2.540
Fabric gr. 5	Karakorum, Sisu	3-6 weeks	2.512	3.140
Fabric gr. 6	Fuse, Gentle	3-6 weeks	2.752	3.440
Leather	Tailor Semi-aniline leather	3-6 weeks	1.912	2.390
Leather	Noble Aniline leather	3-6 weeks	2.032	2.540
Leather	Elmosoft Semi-aniline leather	3-6 weeks	2.512	3.140
Fabric COM	COM Fabric	3-6 weeks	1.196	1.495



EU Ecolabel certified, validating high standards of durability, circular design, and responsible use of chemicals. Please contact our sales team for a list of EU Ecolabel compliant combinations.

Material: Shell made from 100% recycled polypropylene with fiber glass, covered with HR foam with fabric or leather upholstery, steel tube base.

Fabric usage:

1.9 meter (Shell: 1.2 meters / Seat: 0.7 meter based on a 140 cm roll).

Leather usage: 2.9 square meters (Shell: 2 sqm / Seat: 0.9 sqm) based on a yield of 60% pr hide.

COM must be approved by &Tradition to ensure suitability for upholstery.

Wagner QuickClick Plast gliders are installed as standard.

Wagner QuickClick Felt gliders available upon request.

Minimum order quantity of same variant: 4 pcs.

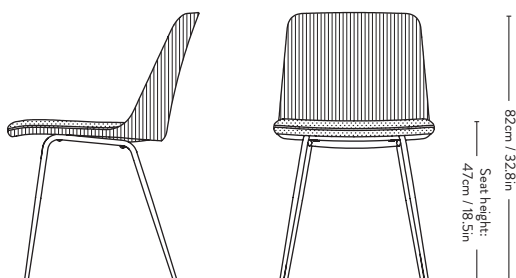

Rely ^{HW11} Hee Welling 2020



Item code	Shell Colour	Model	Base	Lead time	Weight	PRICE EX. VAT (SEK)	PRICE INC. VAT (SEK)
HW	Black	HW11	Black, Bronzed, Polished Aluminium	2-3 weeks	7.80 kg	3.100	3.875
HW	White	HW11	Black, Bronzed, Polished Aluminium	2-3 weeks	7.80 kg	3.100	3.875
HW	Beige Sand	HW11	Black, Bronzed, Polished Aluminium	2-3 weeks	7.80 kg	3.100	3.875
HW	Red Brown	HW11	Black, Bronzed, Polished Aluminium	2-3 weeks	7.80 kg	3.100	3.875
HW	Light Blue	HW11	Black, Bronzed, Polished Aluminium	2-3 weeks	7.80 kg	3.100	3.875
HW	Stone Grey	HW11	Black, Bronzed, Polished Aluminium	2-3 weeks	7.80 kg	3.100	3.875
HW	Vermilion red	HW11	Black, Bronzed, Polished Aluminium	2-3 weeks	7.80 kg	3.100	3.875
HW	Bronze green	HW11	Black, Bronzed, Polished Aluminium	2-3 weeks	7.80 kg	3.100	3.875
HW	Soft Pink	HW11	Black, Bronzed, Polished Aluminium	2-3 weeks	7.80 kg	3.100	3.875

Material: Shell made from 100% recycled polypropylene with fiber glass and an aluminium swivel base.

Plastic gliders installed as standard.
Felt gliders available upon request.

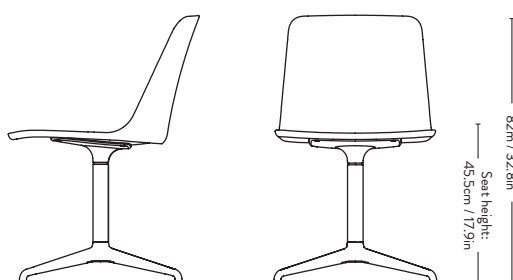

Rely ^{HW12} Hee Welling 2020



Price group	Shell Colour	Seat Cushion Upholstery	Base	Lead time	Weight	PRICE EX. VAT (SEK)	PRICE INC. VAT (SEK)
Fabric gr. 1	Black, White, Beige Sand, Red Brown, Light Blue, Stone Grey, Vermilion red, Bronze green, Soft Pink	Hot Madison, Remix, Re-Wool	Black, Bronzed, Polished Aluminium	3-6 weeks	9.10 kg	4.652	5.815
Fabric gr. 2	Black, White, Beige Sand, Red Brown, Light Blue, Stone Grey, Vermilion red, Bronze green, Soft Pink	Canvas, Barnum, Fiord, Ritz	Black, Bronzed, Polished Aluminium	3-6 weeks	9.10 kg	5.008	6.260
Fabric gr. 3	Black, White, Beige Sand, Red Brown, Light Blue, Stone Grey, Vermilion red, Bronze green, Soft Pink	Clay, Hallingdal, Steelcut Quartet, Steelcut Trio	Black, Bronzed, Polished Aluminium	3-6 weeks	9.10 kg	5.128	6.410
Fabric gr. 4	Black, White, Beige Sand, Red Brown, Light Blue, Stone Grey, Vermilion red, Bronze green, Soft Pink	Acca, Cifrado, Ecriture, Moss, Uniform Melange, Vidar	Black, Bronzed, Polished Aluminium	3-6 weeks	9.10 kg	5.488	6.860
Fabric gr. 5	Black, White, Beige Sand, Red Brown, Light Blue, Stone Grey, Vermilion red, Bronze green, Soft Pink	Karakorum, Sisu	Black, Bronzed, Polished Aluminium	3-6 weeks	9.10 kg	5.964	7.455
Fabric gr. 6	Black, White, Beige Sand, Red Brown, Light Blue, Stone Grey, Vermilion red, Bronze green, Soft Pink	Fuse, Gentle	Black, Bronzed, Polished Aluminium	3-6 weeks	9.10 kg	6.560	8.200
Leather	Black, White, Beige Sand, Red Brown, Light Blue, Stone Grey, Vermilion red, Bronze green, Soft Pink	Tailor Semi-aniline leather	Black, Bronzed, Polished Aluminium	3-6 weeks	9.10 kg	5.128	6.410
Leather	Black, White, Beige Sand, Red Brown, Light Blue, Stone Grey, Vermilion red, Bronze green, Soft Pink	Noble Aniline leather	Black, Bronzed, Polished Aluminium	3-6 weeks	9.10 kg	5.488	6.860
Leather	Black, White, Beige Sand, Red Brown, Light Blue, Stone Grey, Vermilion red, Bronze green, Soft Pink	Elmosoft Semi-aniline leather	Black, Bronzed, Polished Aluminium	3-6 weeks	9.10 kg	5.844	7.305
Fabric COM	Black, White, Beige Sand, Red Brown, Light Blue, Stone Grey, Vermilion red, Bronze green, Soft Pink	COM Fabric	Black, Bronzed, Polished Aluminium	3-6 weeks	9.10 kg	4.652	5.815

Material: Shell made from 100% recycled polypropylene with fiber glass, HR foam seat covered with fabric or leather upholstery, aluminium swivel base.

Fabric usage: 0.49 meter based on a 140 cm roll.

Leather usage: 1 square meter based on a yield of 60% pr hide.

COM must be approved by Tradition to ensure suitability for upholstery.

Plastic gliders installed as standard.

Felt gliders available upon request.

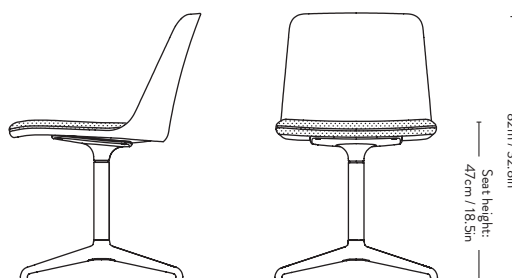

Rely^{HW13} Hee Welling 2020



Price group	Upholstery	Model	Base	Lead time	Weight	PRICE EX. VAT (SEK)	PRICE INC. VAT (SEK)
Fabric gr. 1	Hot Madison, Remix, Re-Wool	HW13	Black, Bronzed, Polished Aluminium	3-6 weeks	8.30 kg	5.368	6.710
Fabric gr. 2	Canvas, Barnum, Fiord, Ritz	HW13	Black, Bronzed, Polished Aluminium	3-6 weeks	8.30 kg	6.084	7.605
Fabric gr. 3	Clay, Hallingdal, Steelcut Quartet, Steelcut Trio	HW13	Black, Bronzed, Polished Aluminium	3-6 weeks	8.30 kg	6.324	7.905
Fabric gr. 4	Acca, Cifrado, Ecriture, Moss, Uniform Melange, Vidar	HW13	Black, Bronzed, Polished Aluminium	3-6 weeks	8.30 kg	6.920	8.650
Fabric gr. 5	Karakorum, Sisu	HW13	Black, Bronzed, Polished Aluminium	3-6 weeks	8.30 kg	8.352	10.440
Fabric gr. 6	Fuse, Gentle	HW13	Black, Bronzed, Polished Aluminium	3-6 weeks	8.30 kg	9.188	11.485
Leather	Tailor Semi-aniline leather	HW13	Black, Bronzed, Polished Aluminium	3-6 weeks	8.30 kg	7.276	9.095
Leather	Noble Aniline leather	HW13	Black, Bronzed, Polished Aluminium	3-6 weeks	8.30 kg	7.636	9.545
Leather	Elmosoft Semi-aniline leather	HW13	Black, Bronzed, Polished Aluminium	3-6 weeks	8.30 kg	8.232	10.290
Fabric COM	COM Fabric	HW13	Black, Bronzed, Polished Aluminium	3-6 weeks	8.30 kg	5.368	6.710

Material: Shell made from 100% recycled polypropylene with fiber glass, covered in HR foam with fabric or leather upholstery, aluminium swivel base.

Fabric usage: 1.40 meters based on a 140cm roll.

Leather usage: 2.2 square meters based on a yield of 60% pr hide.

COM must be approved by &Tradition to ensure suitability for upholstery.

Plastic gliders installed as standard.

Felt gliders available upon request.

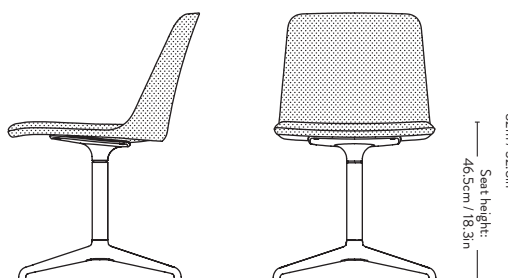

Rely ^{HW14} Hee Welling 2020



Price group	Upholstery	Model	Base	Lead time	Weight	PRICE EX. VAT (SEK)	PRICE INC. VAT (SEK)
Fabric gr. 1	Hot Madison, Remix, Re-Wool	HW14	Black, Bronzed, Polished Aluminium	3-6 weeks	9.40 kg	5.604	7.005
Fabric gr. 2	Canvas, Barnum, Fiord, Ritz	HW14	Black, Bronzed, Polished Aluminium	3-6 weeks	9.40 kg	6.324	7.905
Fabric gr. 3	Clay, Hallingdal, Steelcut Quartet, Steelcut Trio	HW14	Black, Bronzed, Polished Aluminium	3-6 weeks	9.40 kg	6.560	8.200
Fabric gr. 4	Acca, Cifrado, Ecriture, Moss, Uniform Melange, Vidar	HW14	Black, Bronzed, Polished Aluminium	3-6 weeks	9.40 kg	7.160	8.950
Fabric gr. 5	Karakorum, Sisu	HW14	Black, Bronzed, Polished Aluminium	3-6 weeks	9.40 kg	8.592	10.740
Fabric gr. 6	Fuse, Gentle	HW14	Black, Bronzed, Polished Aluminium	3-6 weeks	9.40 kg	9.428	11.785
Leather	Tailor Semi-aniline leather	HW14	Black, Bronzed, Polished Aluminium	3-6 weeks	9.40 kg	7.516	9.395
Leather	Noble Aniline leather	HW14	Black, Bronzed, Polished Aluminium	3-6 weeks	9.40 kg	7.876	9.845
Leather	Elmosoft Semi-aniline leather	HW14	Black, Bronzed, Polished Aluminium	3-6 weeks	9.40 kg	8.712	10.890
Fabric COM	COM Fabric	HW14	Black, Bronzed, Polished Aluminium	3-6 weeks	9.40 kg	5.604	7.005

Material: Shell made from 100% recycled polypropylene with fiber glass, covered in HR foam with fabric or leather upholstery, aluminium swivel base.

Fabric usage: 1.8 meters based on a 140cm roll.

Leather usage: 2.7 square meters based on a yield of 60% pr hide.

COM must be approved by &Tradition to ensure suitability for upholstery.

Plastic gliders installed as standard.

Felt gliders available upon request.

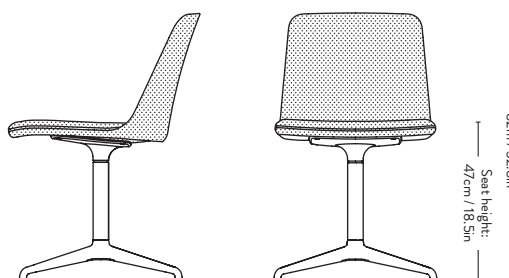

Rely ^{HW15} Hee Welling 2020



Please note that price is accumulated price of shell & seat.

Price group	Shell Upholstery	Base	Lead time	Weight	PRICE EX. VAT (SEK)	PRICE INC. VAT (SEK)
Fabric gr. 1	Hot Madison, Remix, Re-Wool	Black, Bronzed, Polished Aluminium	3-6 weeks	9.40 kg	4.408	5.510
Fabric gr. 2	Canvas, Barnum, Fiord, Ritz	Black, Bronzed, Polished Aluminium	3-6 weeks	9.40 kg	4.776	5.970
Fabric gr. 3	Clay, Hallingdal, Steelcut Quartet, Steelcut Trio	Black, Bronzed, Polished Aluminium	3-6 weeks	9.40 kg	4.896	6.120
Fabric gr. 4	Acca, Cifrado, Ecriture, Moss, Uniform Melange, Vidar	Black, Bronzed, Polished Aluminium	3-6 weeks	9.40 kg	5.132	6.415
Fabric gr. 5	Karakorum, Sisu	Black, Bronzed, Polished Aluminium	3-6 weeks	9.40 kg	6.092	7.615
Fabric gr. 6	Fuse, Gentle	Black, Bronzed, Polished Aluminium	3-6 weeks	9.40 kg	6.692	8.365
Leather	Tailor Semi-aniline leather	Black, Bronzed, Polished Aluminium	3-6 weeks	9.40 kg	5.616	7.020
Leather	Noble Aniline leather	Black, Bronzed, Polished Aluminium	3-6 weeks	9.40 kg	5.848	7.310
Leather	Elmosoft Semi-aniline leather	Black, Bronzed, Polished Aluminium	3-6 weeks	9.40 kg	6.212	7.765
Fabric COM	COM Fabric	Black, Bronzed, Polished Aluminium	3-6 weeks	9.40 kg	4.408	5.510

Price group	Seat Upholstery	Lead time	PRICE EX. VAT (SEK)	PRICE INC. VAT (SEK)
Fabric gr. 1	Hot Madison, Remix, Re-Wool	3-6 weeks	1.196	1.495
Fabric gr. 2	Canvas, Barnum, Fiord, Ritz	3-6 weeks	1.556	1.945
Fabric gr. 3	Clay, Hallingdal, Steelcut Quartet, Steelcut Trio	3-6 weeks	1.676	2.095
Fabric gr. 4	Acca, Cifrado, Ecriture, Moss, Uniform Melange, Vidar	3-6 weeks	2.032	2.540
Fabric gr. 5	Karakorum, Sisu	3-6 weeks	2.512	3.140
Fabric gr. 6	Fuse, Gentle	3-6 weeks	2.752	3.440
Leather	Tailor Semi-aniline leather	3-6 weeks	1.912	2.390
Leather	Noble Aniline leather	3-6 weeks	2.032	2.540
Leather	Elmosoft Semi-aniline leather	3-6 weeks	2.512	3.140
Fabric COM	COM Fabric	3-6 weeks	1.196	1.495

Material: Shell made from 100% recycled polypropylene with fiber glass, covered in HR foam with fabric or leather upholstery, aluminium swivel base.

Fabric usage: 1.9 meter (Shell: 1.2 meters / Seat: 0.7 meter).

Leather usage: 2.9 square meters (Shell: 2 sqm / Seat: 0.9 sqm) based on a yield of 60% pr hide.

COM must be approved by &Tradition to ensure suitability for upholstery.

Plastic gliders installed as standard.

Felt gliders available upon request.

Minimum order quantity of same variant: 4 pcs.

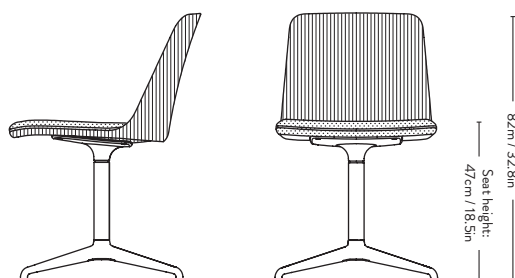

Rely ^{HW16} Hee Welling 2020



Item code	Shell Colour	Model	Base	Lead time	Weight	PRICE EX. VAT (SEK)	PRICE INC. VAT (SEK)
HW	Black	HW16	Black, Bronzed, Polished Aluminium	2-3 weeks	7.80 kg	3.576	4.470
HW	White	HW16	Black, Bronzed, Polished Aluminium	2-3 weeks	7.80 kg	3.576	4.470
HW	Beige Sand	HW16	Black, Bronzed, Polished Aluminium	2-3 weeks	7.80 kg	3.576	4.470
HW	Red Brown	HW16	Black, Bronzed, Polished Aluminium	2-3 weeks	7.80 kg	3.576	4.470
HW	Light Blue	HW16	Black, Bronzed, Polished Aluminium	2-3 weeks	7.80 kg	3.576	4.470
HW	Stone Grey	HW16	Black, Bronzed, Polished Aluminium	2-3 weeks	7.80 kg	3.576	4.470
HW	Vermilion red	HW16	Black, Bronzed, Polished Aluminium	2-3 weeks	7.80 kg	3.576	4.470
HW	Bronze green	HW16	Black, Bronzed, Polished Aluminium	2-3 weeks	7.80 kg	3.576	4.470
HW	Soft Pink	HW16	Black, Bronzed, Polished Aluminium	2-3 weeks	7.80 kg	3.576	4.470

Material: Shell made from 100% recycled polypropylene with fiber glass, aluminium swivel base with return.

Plastic gliders installed as standard.
Felt gliders available upon request.

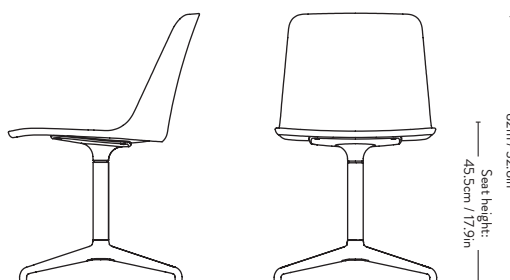

Rely^{HW17} Hee Welling 2020



Price group	Shell Colour	Seat Cushion Upholstery	Base	Lead time	Weight	PRICE EX. VAT (SEK)	PRICE INC. VAT (SEK)
Fabric gr. 1	Black, White, Beige Sand, Red Brown, Light Blue, Stone Grey, Vermilion red, Bronze green, Soft Pink	Hot Madison, Remix, Re-Wool	Black, Bronzed, Polished Aluminium	3-6 weeks	9.10 kg	5.128	6.410
Fabric gr. 2	Black, White, Beige Sand, Red Brown, Light Blue, Stone Grey, Vermilion red, Bronze green, Soft Pink	Canvas, Barnum, Fiord, Ritz	Black, Bronzed, Polished Aluminium	3-6 weeks	9.10 kg	5.488	6.860
Fabric gr. 3	Black, White, Beige Sand, Red Brown, Light Blue, Stone Grey, Vermilion red, Bronze green, Soft Pink	Clay, Hallingdal, Steelcut Quartet, Steelcut Trio	Black, Bronzed, Polished Aluminium	3-6 weeks	9.10 kg	5.604	7.005
Fabric gr. 4	Black, White, Beige Sand, Red Brown, Light Blue, Stone Grey, Vermilion red, Bronze green, Soft Pink	Acca, Cifrado, Ecriture, Moss, Uniform Melange, Vidar	Black, Bronzed, Polished Aluminium	3-6 weeks	9.10 kg	5.964	7.455
Fabric gr. 5	Black, White, Beige Sand, Red Brown, Light Blue, Stone Grey, Vermilion red, Bronze green, Soft Pink	Karakorum, Sisu	Black, Bronzed, Polished Aluminium	3-6 weeks	9.10 kg	6.440	8.050
Fabric gr. 6	Black, White, Beige Sand, Red Brown, Light Blue, Stone Grey, Vermilion red, Bronze green, Soft Pink	Fuse, Gentle	Black, Bronzed, Polished Aluminium	3-6 weeks	9.10 kg	7.040	8.800
Leather	Black, White, Beige Sand, Red Brown, Light Blue, Stone Grey, Vermilion red, Bronze green, Soft Pink	Tailor Semi-aniline leather	Black, Bronzed, Polished Aluminium	3-6 weeks	9.10 kg	5.604	7.005
Leather	Black, White, Beige Sand, Red Brown, Light Blue, Stone Grey, Vermilion red, Bronze green, Soft Pink	Noble Aniline leather	Black, Bronzed, Polished Aluminium	3-6 weeks	9.10 kg	5.964	7.455
Leather	Black, White, Beige Sand, Red Brown, Light Blue, Stone Grey, Vermilion red, Bronze green, Soft Pink	Elmosoft Semi-aniline leather	Black, Bronzed, Polished Aluminium	3-6 weeks	9.10 kg	6.324	7.905
Fabric COM	Black, White, Beige Sand, Red Brown, Light Blue, Stone Grey, Vermilion red, Bronze green, Soft Pink	COM Fabric	Black, Bronzed, Polished Aluminium	3-6 weeks	9.10 kg	5.128	6.410

Material: Shell made from 100% recycled polypropylene with fiber glass, seat covered in HR foam with fabric or leather upholstery, aluminium swivel base with return function.

Fabric usage: 0.49 meter based on a 140 cm roll.

Leather usage: 1 square meter based on a yield of 60% pr hide.

COM must be approved by &Tradition to ensure suitability for upholstery.

Plastic gliders installed as standard.

Felt gliders available upon request.

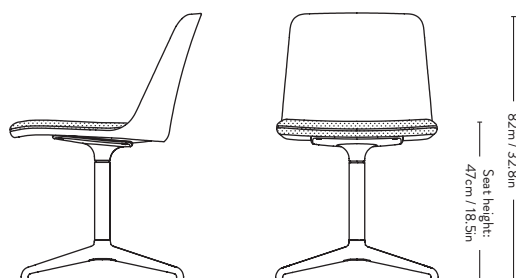

Rely^{HW18} Hee Welling 2020



Price group	Upholstery	Model	Base	Lead time	Weight	PRICE EX. VAT (SEK)	PRICE INC. VAT (SEK)
Fabric gr. 1	Hot Madison, Remix, Re-Wool	HW18	Black, Bronzed, Polished Aluminium	3-6 weeks	8.30 kg	5.844	7.305
Fabric gr. 2	Canvas, Barnum, Fiord, Ritz	HW18	Black, Bronzed, Polished Aluminium	3-6 weeks	8.30 kg	6.560	8.200
Fabric gr. 3	Clay, Hallingdal, Steelcut Quartet, Steelcut Trio	HW18	Black, Bronzed, Polished Aluminium	3-6 weeks	8.30 kg	6.800	8.500
Fabric gr. 4	Acca, Cifrado, Ecriture, Moss, Uniform Melange, Vidar	HW18	Black, Bronzed, Polished Aluminium	3-6 weeks	8.30 kg	7.396	9.245
Fabric gr. 5	Karakorum, Sisu	HW18	Black, Bronzed, Polished Aluminium	3-6 weeks	8.30 kg	8.828	11.035
Fabric gr. 6	Fuse, Gentle	HW18	Black, Bronzed, Polished Aluminium	3-6 weeks	8.30 kg	9.664	12.080
Leather	Tailor Semi-aniline leather	HW18	Black, Bronzed, Polished Aluminium	3-6 weeks	8.30 kg	7.756	9.695
Leather	Noble Aniline leather	HW18	Black, Bronzed, Polished Aluminium	3-6 weeks	8.30 kg	8.112	10.140
Leather	Elmosoft Semi-aniline leather	HW18	Black, Bronzed, Polished Aluminium	3-6 weeks	8.30 kg	8.592	10.740
Fabric COM	COM Fabric	HW18	Black, Bronzed, Polished Aluminium	3-6 weeks	8.30 kg	5.844	7.305

Material: Shell made from 100% recycled polypropylene with fiber glass, covered in HR foam with fabric or leather upholstery, aluminium swivel base with return function.

Fabric usage: 1.40 meters based on a 140cm roll.

Leather usage: 2.2 square meters based on a yield of 60% pr hide.

COM must be approved by &Tradition to ensure suitability for upholstery.

Plastic gliders installed as standard.

Felt gliders available upon request.

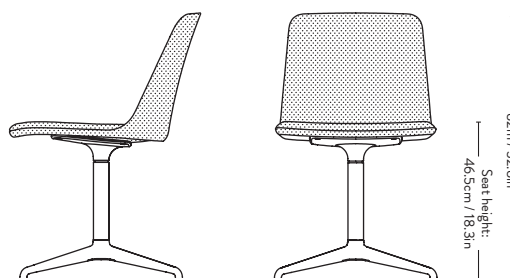

37cm / 14.6in

47cm / 18.8in

Seating depth: 46cm / 18.1in

22% RABATT SKA DRAS AV PÅ ANGIVNA PRISER

Rely ^{HW19} Hee Welling 2020



Price group	Upholstery	Model	Base	Lead time	Weight	PRICE EX. VAT (SEK)	PRICE INC. VAT (SEK)
Fabric gr. 1	Hot Madison, Remix, Re-Wool	HW19	Black, Bronzed, Polished Aluminium	3-6 weeks	9.40 kg	6.084	7.605
Fabric gr. 2	Canvas, Barnum, Fiord, Ritz	HW19	Black, Bronzed, Polished Aluminium	3-6 weeks	9.40 kg	6.800	8.500
Fabric gr. 3	Clay, Hallingdal, Steelcut Quartet, Steelcut Trio	HW19	Black, Bronzed, Polished Aluminium	3-6 weeks	9.40 kg	7.040	8.800
Fabric gr. 4	Acca, Cifrado, Ecriture, Moss, Uniform Melange, Vidar	HW19	Black, Bronzed, Polished Aluminium	3-6 weeks	9.40 kg	7.636	9.545
Fabric gr. 5	Karakorum, Sisu	HW19	Black, Bronzed, Polished Aluminium	3-6 weeks	9.40 kg	9.068	11.335
Fabric gr. 6	Fuse, Gentle	HW19	Black, Bronzed, Polished Aluminium	3-6 weeks	9.40 kg	10.024	12.530
Leather	Tailor Semi-aniline leather	HW19	Black, Bronzed, Polished Aluminium	3-6 weeks	9.40 kg	7.996	9.995
Leather	Noble Aniline leather	HW19	Black, Bronzed, Polished Aluminium	3-6 weeks	9.40 kg	8.352	10.440
Leather	Elmosoft Semi-aniline leather	HW19	Black, Bronzed, Polished Aluminium	3-6 weeks	9.40 kg	9.188	11.485
Fabric COM	COM Fabric	HW19	Black, Bronzed, Polished Aluminium	3-6 weeks	9.40 kg	6.084	7.605

Material: Shell made from 100% recycled polypropylene with fiber glass, covered in HR foam with fabric or leather upholstery, aluminium swivel base with return function.

Fabric usage: 1.8 meters based on a 140cm roll.

Leather usage: 2.7 square meters based on a yield of 60% pr hide.

COM must be approved by &Tradition to ensure suitability for upholstery.

Plastic gliders installed as standard.

Felt gliders available upon request.

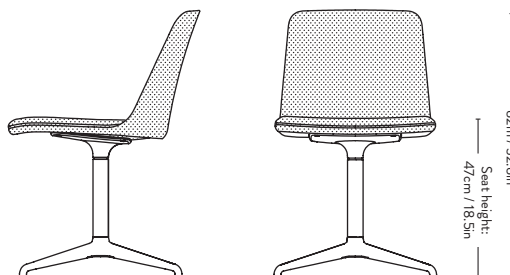

Rely^{HW20} Hee Welling 2020



Please note that price is accumulated price of shell & seat.

Price group	Shell Upholstery	Base	Lead time	Weight	PRICE EX. VAT (SEK)	PRICE INC. VAT (SEK)
Fabric gr. 1	Hot Madison, Remix, Re-Wool	Black, Bronzed, Polished Aluminium	3-6 weeks	9.40 kg	4.896	6.120
Fabric gr. 2	Canvas, Barnum, Fiord, Ritz	Black, Bronzed, Polished Aluminium	3-6 weeks	9.40 kg	5.256	6.570
Fabric gr. 3	Clay, Hallingdal, Steelcut Quartet, Steelcut Trio	Black, Bronzed, Polished Aluminium	3-6 weeks	9.40 kg	5.376	6.720
Fabric gr. 4	Acca, Cifrado, Ecriture, Moss, Uniform Melange, Vidar	Black, Bronzed, Polished Aluminium	3-6 weeks	9.40 kg	5.608	7.010
Fabric gr. 5	Karakorum, Sisu	Black, Bronzed, Polished Aluminium	3-6 weeks	9.40 kg	6.572	8.215
Fabric gr. 6	Fuse, Gentle	Black, Bronzed, Polished Aluminium	3-6 weeks	9.40 kg	7.288	9.110
Leather	Tailor Semi-aniline leather	Black, Bronzed, Polished Aluminium	3-6 weeks	9.40 kg	6.092	7.615
Leather	Noble Aniline leather	Black, Bronzed, Polished Aluminium	3-6 weeks	9.40 kg	6.332	7.915
Leather	Elmosoft Semi-aniline leather	Black, Bronzed, Polished Aluminium	3-6 weeks	9.40 kg	6.692	8.365
Fabric COM	COM Fabric	Black, Bronzed, Polished Aluminium	3-6 weeks	9.40 kg	4.896	6.120

Price group	Seat Upholstery	Lead time	PRICE EX. VAT (SEK)	PRICE INC. VAT (SEK)
Fabric gr. 1	Hot Madison, Remix, Re-Wool	3-6 weeks	1.196	1.495
Fabric gr. 2	Canvas, Barnum, Fiord, Ritz	3-6 weeks	1.556	1.945
Fabric gr. 3	Clay, Hallingdal, Steelcut Quartet, Steelcut Trio	3-6 weeks	1.676	2.095
Fabric gr. 4	Acca, Cifrado, Ecriture, Moss, Uniform Melange, Vidar	3-6 weeks	2.032	2.540
Fabric gr. 5	Karakorum, Sisu	3-6 weeks	2.512	3.140
Fabric gr. 6	Fuse, Gentle	3-6 weeks	2.752	3.440
Leather	Tailor Semi-aniline leather	3-6 weeks	1.912	2.390
Leather	Noble Aniline leather	3-6 weeks	2.032	2.540
Leather	Elmosoft Semi-aniline leather	3-6 weeks	2.512	3.140
Fabric COM	COM Fabric	3-6 weeks	1.196	1.495

Material: Shell made from 100% recycled polypropylene with fiber glass, covered in HR foam with fabric or leather upholstery, aluminium swivel base with return function.

Fabric usage: 1.9 meter (Shell: 1.2 meters / Seat: 0.7 meter).

Leather usage: 2.9 square meters (Shell: 2 sqm / Seat: 0.9 sqm) based on a yield of 60% pr hide.

COM must be approved by &Tradition to ensure suitability for upholstery.

Plastic gliders installed as standard.
Felt gliders available upon request.

Minimum order quantity of same variant: 4 pcs.

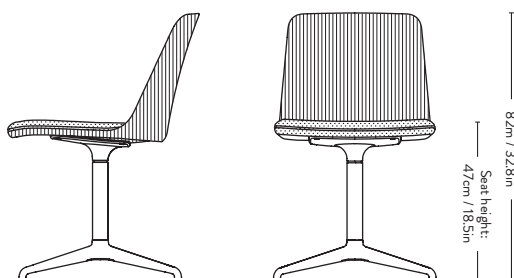

57cm / 22.8in

47cm / 18.5in

Seating depth: 45cm / 17.7in

Rely ^{HW21} Hee Welling 2020



Item code	Shell Colour	Model	Base	Lead time	Weight	PRICE EX. VAT (SEK)	PRICE INC. VAT (SEK)
HW	Black	HW21	Black, Bronzed, Polished Aluminium	2-3 weeks	7.80 kg	3.576	4.470
HW	White	HW21	Black, Bronzed, Polished Aluminium	2-3 weeks	7.80 kg	3.576	4.470
HW	Beige Sand	HW21	Black, Bronzed, Polished Aluminium	2-3 weeks	7.80 kg	3.576	4.470
HW	Red Brown	HW21	Black, Bronzed, Polished Aluminium	2-3 weeks	7.80 kg	3.576	4.470
HW	Light Blue	HW21	Black, Bronzed, Polished Aluminium	2-3 weeks	7.80 kg	3.576	4.470
HW	Stone Grey	HW21	Black, Bronzed, Polished Aluminium	2-3 weeks	7.80 kg	3.576	4.470
HW	Vermilion red	HW21	Black, Bronzed, Polished Aluminium	2-3 weeks	7.80 kg	3.576	4.470
HW	Bronze green	HW21	Black, Bronzed, Polished Aluminium	2-3 weeks	7.80 kg	3.576	4.470
HW	Soft Pink	HW21	Black, Bronzed, Polished Aluminium	2-3 weeks	7.80 kg	3.576	4.470

Material: Shell made from 100% recycled polypropylene with fiber glass, aluminium swivel base with castors.

Castors suitable for all floor types.

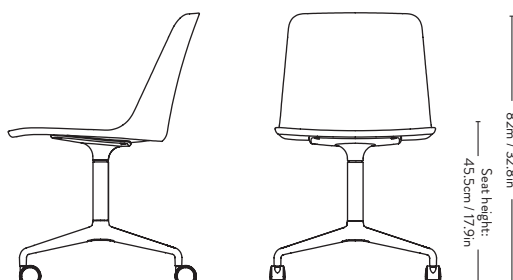

Rely ^{HW22} Hee Welling 2020



Price group	Shell Colour	Seat Cushion Upholstery	Base	Lead time	Weight	PRICE EX. VAT (SEK)	PRICE INC. VAT (SEK)
Fabric gr. 1	Black, White, Beige Sand, Red Brown, Light Blue, Stone Grey, Vermilion red, Bronze green, Soft Pink	Hot Madison, Remix, Re-Wool	Black, Bronzed, Polished Aluminium	3-6 weeks	9.10 kg	5.128	6.410
Fabric gr. 2	Black, White, Beige Sand, Red Brown, Light Blue, Stone Grey, Vermilion red, Bronze green, Soft Pink	Canvas, Barnum, Fiord, Ritz	Black, Bronzed, Polished Aluminium	3-6 weeks	9.10 kg	5.488	6.860
Fabric gr. 3	Black, White, Beige Sand, Red Brown, Light Blue, Stone Grey, Vermilion red, Bronze green, Soft Pink	Clay, Hallingdal, Steelcut Quartet, Steelcut Trio	Black, Bronzed, Polished Aluminium	3-6 weeks	9.10 kg	5.604	7.005
Fabric gr. 4	Black, White, Beige Sand, Red Brown, Light Blue, Stone Grey, Vermilion red, Bronze green, Soft Pink	Acca, Cifrado, Ecriture, Moss, Uniform Melange, Vidar	Black, Bronzed, Polished Aluminium	3-6 weeks	9.10 kg	5.844	7.305
Fabric gr. 5	Black, White, Beige Sand, Red Brown, Light Blue, Stone Grey, Vermilion red, Bronze green, Soft Pink	Karakorum, Sisu	Black, Bronzed, Polished Aluminium	3-6 weeks	9.10 kg	6.440	8.050
Fabric gr. 6	Black, White, Beige Sand, Red Brown, Light Blue, Stone Grey, Vermilion red, Bronze green, Soft Pink	Fuse, Gentle	Black, Bronzed, Polished Aluminium	3-6 weeks	9.10 kg	7.040	8.800
Leather	Black, White, Beige Sand, Red Brown, Light Blue, Stone Grey, Vermilion red, Bronze green, Soft Pink	Tailor Semi-aniline leather	Black, Bronzed, Polished Aluminium	3-6 weeks	9.10 kg	5.724	7.155
Leather	Black, White, Beige Sand, Red Brown, Light Blue, Stone Grey, Vermilion red, Bronze green, Soft Pink	Noble Aniline leather	Black, Bronzed, Polished Aluminium	3-6 weeks	9.10 kg	6.084	7.605
Leather	Black, White, Beige Sand, Red Brown, Light Blue, Stone Grey, Vermilion red, Bronze green, Soft Pink	Elmosoft Semi-aniline leather	Black, Bronzed, Polished Aluminium	3-6 weeks	9.10 kg	6.440	8.050
Fabric COM	Black, White, Beige Sand, Red Brown, Light Blue, Stone Grey, Vermilion red, Bronze green, Soft Pink	COM Fabric	Black, Bronzed, Polished Aluminium	3-6 weeks	9.10 kg	5.128	6.410

Material: Shell made from 100% recycled polypropylene with fiber glass, seat covered in HR foam with fabric or leather upholstery, aluminium swivel base with castors.

Fabric usage: 0.49 meter

Leather usage: 1 square meter based on a yield of 60% pr hide.

COM must be approved by &Tradition to ensure suitability for upholstery.

Castors suitable for all floor types.

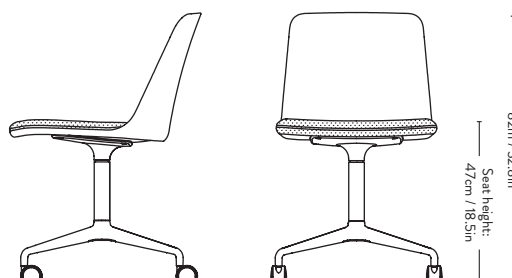

Rely ^{HW23} Hee Welling 2020



Price group	Upholstery	Model	Base	Lead time	Weight	PRICE EX. VAT (SEK)	PRICE INC. VAT (SEK)
Fabric gr. 1	Hot Madison, Remix, Re-Wool	HW23	Black, Bronzed, Polished Aluminium	3-6 weeks	8.30 kg	5.844	7.305
Fabric gr. 2	Canvas, Barnum, Fiord, Ritz	HW23	Black, Bronzed, Polished Aluminium	3-6 weeks	8.30 kg	6.560	8.200
Fabric gr. 3	Clay, Hallingdal, Steelcut Quartet, Steelcut Trio	HW23	Black, Bronzed, Polished Aluminium	3-6 weeks	8.30 kg	6.800	8.500
Fabric gr. 4	Acca, Cifrado, Ecriture, Moss, Uniform Melange, Vidar	HW23	Black, Bronzed, Polished Aluminium	3-6 weeks	8.30 kg	7.396	9.245
Fabric gr. 5	Karakorum, Sisu	HW23	Black, Bronzed, Polished Aluminium	3-6 weeks	8.30 kg	8.828	11.035
Fabric gr. 6	Fuse, Gentle	HW23	Black, Bronzed, Polished Aluminium	3-6 weeks	8.30 kg	9.664	12.080
Leather	Tailor Semi-aniline leather	HW23	Black, Bronzed, Polished Aluminium	3-6 weeks	8.30 kg	7.756	9.695
Leather	Noble Aniline leather	HW23	Black, Bronzed, Polished Aluminium	3-6 weeks	8.30 kg	8.112	10.140
Leather	Elmosoft Semi-aniline leather	HW23	Black, Bronzed, Polished Aluminium	3-6 weeks	8.30 kg	8.712	10.890
Fabric COM	COM Fabric	HW23	Black, Bronzed, Polished Aluminium	3-6 weeks	8.30 kg	5.844	7.305

Material: Shell made from 100% recycled polypropylene with fiber glass, covered in HR foam with fabric or leather upholstery, aluminium swivel base with castors.

Fabric usage: 1.40 meters based on a 140cm roll.

Leather usage: 2.2 square meters based on a yield of 60% pr hide.

COM must be approved by &Tradition to ensure suitability for upholstery.

Castors suitable for all floor types.

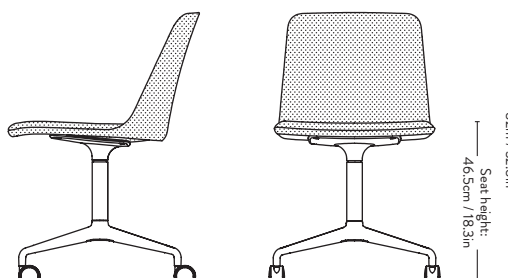

Rely ^{HW24} Hee Welling 2020



Price group	Upholstery	Model	Base	Lead time	Weight	PRICE EX. VAT (SEK)	PRICE INC. VAT (SEK)
Fabric gr. 1	Hot Madison, Remix, Re-Wool	HW24	Black, Bronzed, Polished Aluminium	3-6 weeks	9.40 kg	6.084	7.605
Fabric gr. 2	Canvas, Barnum, Fiord, Ritz	HW24	Black, Bronzed, Polished Aluminium	3-6 weeks	9.40 kg	6.800	8.500
Fabric gr. 3	Clay, Hallingdal, Steelcut Quartet, Steelcut Trio	HW24	Black, Bronzed, Polished Aluminium	3-6 weeks	9.40 kg	7.040	8.800
Fabric gr. 4	Acca, Cifrado, Ecriture, Moss, Uniform Melange, Vidar	HW24	Black, Bronzed, Polished Aluminium	3-6 weeks	9.40 kg	7.636	9.545
Fabric gr. 5	Karakorum, Sisu	HW24	Black, Bronzed, Polished Aluminium	3-6 weeks	9.40 kg	9.068	11.335
Fabric gr. 6	Fuse, Gentle	HW24	Black, Bronzed, Polished Aluminium	3-6 weeks	9.40 kg	10.024	12.530
Leather	Tailor Semi-aniline leather	HW24	Black, Bronzed, Polished Aluminium	3-6 weeks	9.40 kg	7.996	9.995
Leather	Noble Aniline leather	HW24	Black, Bronzed, Polished Aluminium	3-6 weeks	9.40 kg	8.352	10.440
Leather	Elmosoft Semi-aniline leather	HW24	Black, Bronzed, Polished Aluminium	3-6 weeks	9.40 kg	9.188	11.485
Fabric COM	COM Fabric	HW24	Black, Bronzed, Polished Aluminium	3-6 weeks	9.40 kg	6.084	7.605

Material: Shell made from 100% recycled polypropylene with fiber glass, covered in HR foam with fabric or leather upholstery, aluminium swivel base with castors.

Fabric usage: 1.8 meters based on a 140cm roll.

Leather usage: 2.7 square meters based on a yield of 60% pr hide.

COM must be approved by &Tradition to ensure suitability for upholstery.

Castors suitable for all floor types.

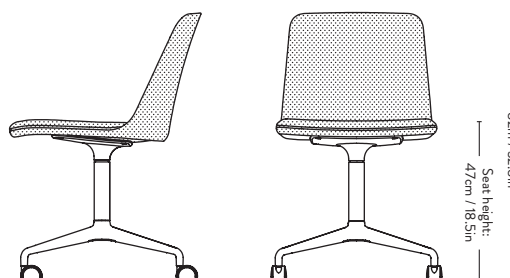

Rely ^{HW25} Hee Welling 2020



Please note that price is accumulated price of shell & seat.

Price group	Shell Upholstery	Base	Lead time	Weight	PRICE EX. VAT (SEK)	PRICE INC. VAT (SEK)
Fabric gr. 1	Hot Madison, Remix, Re-Wool	Black, Bronzed, Polished Aluminium	3-6 weeks	9.40 kg	4.896	6.120
Fabric gr. 2	Canvas, Barnum, Fiord, Ritz	Black, Bronzed, Polished Aluminium	3-6 weeks	9.40 kg	5.256	6.570
Fabric gr. 3	Clay, Hallingdal, Steelcut Quartet, Steelcut Trio	Black, Bronzed, Polished Aluminium	3-6 weeks	9.40 kg	5.376	6.720
Fabric gr. 4	Acca, Cifrado, Ecriture, Moss, Uniform Melange, Vidar	Black, Bronzed, Polished Aluminium	3-6 weeks	9.40 kg	5.608	7.010
Fabric gr. 5	Karakorum, Sisu	Black, Bronzed, Polished Aluminium	3-6 weeks	9.40 kg	6.572	8.215
Fabric gr. 6	Fuse, Gentle	Black, Bronzed, Polished Aluminium	3-6 weeks	9.40 kg	7.288	9.110
Leather	Tailor Semi-aniline leather	Black, Bronzed, Polished Aluminium	3-6 weeks	9.40 kg	6.092	7.615
Leather	Noble Aniline leather	Black, Bronzed, Polished Aluminium	3-6 weeks	9.40 kg	6.332	7.915
Leather	Elmosoft Semi-aniline leather	Black, Bronzed, Polished Aluminium	3-6 weeks	9.40 kg	6.692	8.365
Fabric COM	COM Fabric	Black, Bronzed, Polished Aluminium	3-6 weeks	9.40 kg	4.896	6.120

Price group	Seat Upholstery	Lead time	PRICE EX. VAT (SEK)	PRICE INC. VAT (SEK)
Fabric gr. 1	Hot Madison, Remix, Re-Wool	3-6 weeks	1.196	1.495
Fabric gr. 2	Canvas, Barnum, Fiord, Ritz	3-6 weeks	1.556	1.945
Fabric gr. 3	Clay, Hallingdal, Steelcut Quartet, Steelcut Trio	3-6 weeks	1.676	2.095
Fabric gr. 4	Acca, Cifrado, Ecriture, Moss, Uniform Melange, Vidar	3-6 weeks	2.032	2.540
Fabric gr. 5	Karakorum, Sisu	3-6 weeks	2.512	3.140
Fabric gr. 6	Fuse, Gentle	3-6 weeks	2.752	3.440
Leather	Tailor Semi-aniline leather	3-6 weeks	1.912	2.390
Leather	Noble Aniline leather	3-6 weeks	2.032	2.540
Leather	Elmosoft Semi-aniline leather	3-6 weeks	2.512	3.140
Fabric COM	COM Fabric	3-6 weeks	1.196	1.495

Material: Shell made from 100% recycled polypropylene with fiber glass, covered in HR foam with fabric or leather upholstery, aluminium swivel base with castors.

Fabric usage: 1.9 meter (Shell: 1.2 meters / Seat: 0.7 meter).

Leather usage: 2.9 square meters (Shell: 2 sqm / Seat: 0.9 sqm) based on a yield of 60% pr hide.

COM must be approved by &Tradition to ensure suitability for upholstery.

Castors suitable for all floor types.

Minimum order quantity of same variant: 4 pcs.

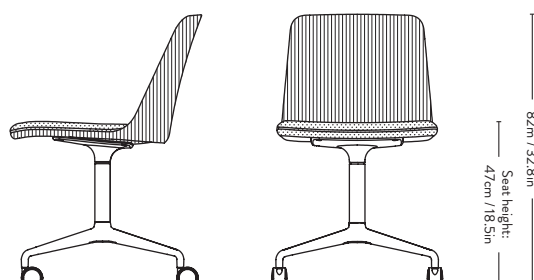

Rely ^{HW26} Hee Welling 2020



Item code	Shell Colour	Model	Base	Lead time	Weight	PRICE EX. VAT (SEK)	PRICE INC. VAT (SEK)
HW	Black	HW26	Chrome, Black	2-3 weeks	5.20 kg	2.264	2.830
HW	White	HW26	Chrome, Black	2-3 weeks	5.20 kg	2.264	2.830
HW	Beige Sand	HW26	Chrome, Black	2-3 weeks	5.20 kg	2.264	2.830
HW	Red Brown	HW26	Chrome, Black	2-3 weeks	5.20 kg	2.264	2.830
HW	Light Blue	HW26	Chrome, Black	2-3 weeks	5.20 kg	2.264	2.830
HW	Stone Grey	HW26	Chrome, Black	2-3 weeks	5.20 kg	2.264	2.830
HW	Vermilion red	HW26	Chrome, Black	2-3 weeks	5.20 kg	2.264	2.830
HW	Bronze green	HW26	Chrome, Black	2-3 weeks	5.20 kg	2.264	2.830
HW	Soft Pink	HW26	Chrome, Black	2-3 weeks	5.20 kg	2.264	2.830
16000000	Rely stacking trolley			2-3 weeks		5.368	6.710

Material: Shell made from 100% recycled polypropylene with fiber glass and a steel tube base.

Wagner QuickClick Plast gliders are installed as standard.
Wagner QuickClick Felt gliders available upon request.

Stacking quantity: 12 pcs (Chrome only).



EU Ecolabel certified, validating high standards of durability, circular design, and responsible use of chemicals. Please contact our sales team for a list of EU Ecolabel compliant combinations.

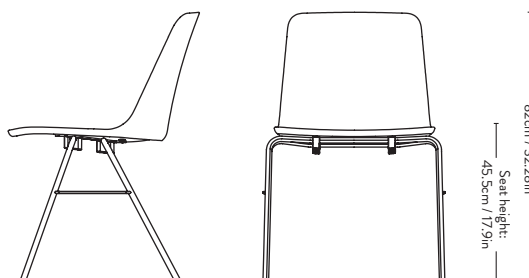

Rely ^{HW27} Hee Welling 2020



Item code	Shell Colour	Model	Base	Lead time	Weight	PRICE EX. VAT (SEK)	PRICE INC. VAT (SEK)
HW	Black	HW27	Chrome	2-3 weeks	5.20 kg	2.384	2.980
HW	White	HW27	Chrome	2-3 weeks	5.20 kg	2.384	2.980
HW	Beige Sand	HW27	Chrome	2-3 weeks	5.20 kg	2.384	2.980
HW	Red Brown	HW27	Chrome	2-3 weeks	5.20 kg	2.384	2.980
HW	Light Blue	HW27	Chrome	2-3 weeks	5.20 kg	2.384	2.980
HW	Stone Grey	HW27	Chrome	2-3 weeks	5.20 kg	2.384	2.980
HW	Vermilion red	HW27	Chrome	2-3 weeks	5.20 kg	2.384	2.980
HW	Bronze green	HW27	Chrome	2-3 weeks	5.20 kg	2.384	2.980
HW	Soft Pink	HW27	Chrome	2-3 weeks	5.20 kg	2.384	2.980
16000000	Rely stacking trolley			2-3 weeks		5.368	6.710

Material: Shell made from 100% recycled polypropylene with fiber glass and a steel tube base.

Wagner QuickClick Plast gliders are installed as standard.
Wagner QuickClick Felt gliders available upon request.

Stacking quantity: 12 pcs



EU Ecolabel certified, validating high standards of durability, circular design, and responsible use of chemicals. Please contact our sales team for a list of EU Ecolabel compliant combinations.

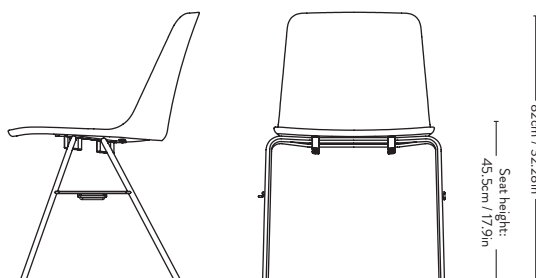

Rely ^{HW65} Hee Welling 2023



Item code	Shell Colour	Model	Base	Colli qty.	Lead time	Weight	PRICE EX. VAT (SEK)	PRICE INC. VAT (SEK)
HW	Black	HW65	Black Chrome NEW	1 pc	2-3 weeks	5.5 kg	2.264	2.830
HW	White	HW65	Black Chrome NEW	1 pc	2-3 weeks	5.5 kg	2.264	2.830
HW	Beige Sand	HW65	Black Chrome NEW	1 pc	2-3 weeks	5.5 kg	2.264	2.830
HW	Red Brown	HW65	Black Chrome NEW	1 pc	2-3 weeks	5.5 kg	2.264	2.830
HW	Light Blue	HW65	Black Chrome NEW	1 pc	2-3 weeks	5.5 kg	2.264	2.830
HW	Stone Grey	HW65	Black Chrome NEW	1 pc	2-3 weeks	5.5 kg	2.264	2.830
HW	Vermilion red	HW65	Black Chrome NEW	1 pc	2-3 weeks	5.5 kg	2.264	2.830
HW	Bronze green	HW65	Black Chrome NEW	1 pc	2-3 weeks	5.5 kg	2.264	2.830
HW	Soft Pink	HW65	Black Chrome NEW	1 pc	2-3 weeks	5.5 kg	2.264	2.830
16000000	Rely stacking trolley				2-3 weeks		5.368	6.710

Material: Shell made from 100% recycled polypropylene with 15% fiber glass

Wagner QuickClick Plast gliders are installed as standard.
Wagner QuickClick Felt gliders available upon request.

Stacking quantity: 12 pcs



EU Ecolabel certified, validating high standards of durability, circular design, and responsible use of chemicals. Please contact our sales team for a list of EU Ecolabel compliant combinations.

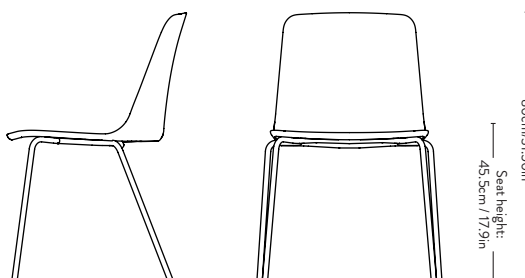

Rely ^{HW66} Hee Welling 2023



Price group	Shell Colour	Seat Cushion Upholstery	Model	Base	Lead time	Weight	PRICE EX. VAT (SEK)	PRICE INC. VAT (SEK)
Fabric gr. 1	Black, White, Beige Sand, Red Brown, Light Blue, Stone Grey, Vermilion red, Bronze green, Soft Pink	Hot Madison, Remix, Re-Wool	HW66	Black Chrome NEW	3-6 weeks	6.50 kg	3.576	4.470
Fabric gr. 2	Black, White, Beige Sand, Red Brown, Light Blue, Stone Grey, Vermilion red, Bronze green, Soft Pink	Canvas, Barnum, Fiord, Ritz	HW66	Black Chrome NEW	3-6 weeks	6.50 kg	3.936	4.920
Fabric gr. 3	Black, White, Beige Sand, Red Brown, Light Blue, Stone Grey, Vermilion red, Bronze green, Soft Pink	Clay, Hallingdal, Steelcut Quartet, Steelcut Trio	HW66	Black Chrome NEW	3-6 weeks	6.50 kg	4.052	5.065
Fabric gr. 4	Black, White, Beige Sand, Red Brown, Light Blue, Stone Grey, Vermilion red, Bronze green, Soft Pink	Acca, Cifrado, Ecriture, Moss, Uniform Melange, Vidar	HW66	Black Chrome NEW	3-6 weeks	6.50 kg	4.412	5.515
Fabric gr. 5	Black, White, Beige Sand, Red Brown, Light Blue, Stone Grey, Vermilion red, Bronze green, Soft Pink	Karakorum, Sisu	HW66	Black Chrome NEW	3-6 weeks	6.50 kg	4.888	6.110
Fabric gr. 6	Black, White, Beige Sand, Red Brown, Light Blue, Stone Grey, Vermilion red, Bronze green, Soft Pink	Fuse, Gentle	HW66	Black Chrome NEW	3-6 weeks	6.50 kg	5.488	6.860
Leather	Black, White, Beige Sand, Red Brown, Light Blue, Stone Grey, Vermilion red, Bronze green, Soft Pink	Tailor Semi-aniline leather	HW66	Black Chrome NEW	3-6 weeks	6.50 kg	3.936	4.920
Leather	Black, White, Beige Sand, Red Brown, Light Blue, Stone Grey, Vermilion red, Bronze green, Soft Pink	Noble Aniline leather	HW66	Black Chrome NEW	3-6 weeks	6.50 kg	4.412	5.515
Leather	Black, White, Beige Sand, Red Brown, Light Blue, Stone Grey, Vermilion red, Bronze green, Soft Pink	Elmosoft Semi-aniline leather	HW66	Black Chrome NEW	3-6 weeks	6.50 kg	4.652	5.815
Fabric COM	Black, White, Beige Sand, Red Brown, Light Blue, Stone Grey, Vermilion red, Bronze green, Soft Pink	COM Fabric	HW66	Black Chrome NEW	3-6 weeks	6.50 kg	3.576	4.470
16000000	Rely stacking trolley				2-3 weeks		5.368	6.710

Material: Shell made from 100% recycled polypropylene with fiber glass, HR foam seat covered with fabric or leather upholstery.

Fabric usage: 0.49 meter based on a 140 cm roll.

Leather usage: 1 square meter based on a yield of 60% pr hide.

Wagner QuickClick Plast gliders are installed as standard.

Wagner QuickClick Felt gliders available upon request.

COM must be approved by &Tradition to ensure suitability for upholstery.

Stacking quantity: 8 pcs



EU Ecolabel certified, validating high standards of durability, circular design, and responsible use of chemicals. Please contact our sales team for a list of EU Ecolabel compliant combinations.

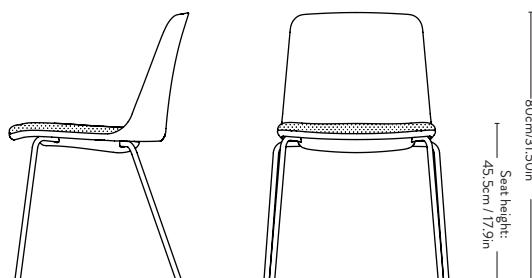

Rely ^{HW67} Hee Welling 2023



Price group	Upholstery	Model	Base	Lead time	Weight	PRICE EX. VAT (SEK)	PRICE INC. VAT (SEK)
Fabric gr. 1	Hot Madison, Remix, Re-Wool	HW67	Black Chrome NEW	3-6 weeks	6.20 kg	4.412	5.515
Fabric gr. 2	Canvas, Barnum, Fiord, Ritz	HW67	Black Chrome NEW	3-6 weeks	6.20 kg	5.128	6.410
Fabric gr. 3	Clay, Hallingdal, Steelcut Quartet, Steelcut Trio	HW67	Black Chrome NEW	3-6 weeks	6.20 kg	5.368	6.710
Fabric gr. 4	Acca, Cifrado, Ecriture, Moss, Uniform Melange, Vidar	HW67	Black Chrome NEW	3-6 weeks	6.20 kg	5.964	7.455
Fabric gr. 5	Karakorum, Sisu	HW67	Black Chrome NEW	3-6 weeks	6.20 kg	7.396	9.245
Fabric gr. 6	Fuse, Gentle	HW67	Black Chrome NEW	3-6 weeks	6.20 kg	8.352	10.440
Leather	Tailor Semi-aniline leather	HW67	Black Chrome NEW	3-6 weeks	6.20 kg	6.440	8.050
Leather	Noble Aniline leather	HW67	Black Chrome NEW	3-6 weeks	6.20 kg	6.800	8.500
Leather	Elmosoft Semi-aniline leather	HW67	Black Chrome NEW	3-6 weeks	6.20 kg	7.396	9.245
Fabric COM	COM Fabric	HW67	Black Chrome NEW	3-6 weeks	6.20 kg	4.412	5.515
16000000	Rely stacking trolley			2-3 weeks		5.368	6.710

Material: Shell made from 100% recycled polypropylene with fiber glass, HR foam seat covered with fabric or leather upholstery

Fabric usage: 1.40 meters based on a 140cm roll.

Leather usage: 2.2 square meters based on a yield of 60% pr hide.

Wagner QuickClick Plast gliders are installed as standard.
Wagner QuickClick Felt gliders available upon request.

COM must be approved by &Tradition to ensure suitability for upholstery.

Stacking quantity: 8 pcs



EU Ecolabel certified, validating high standards of durability, circular design, and responsible use of chemicals. Please contact our sales team for a list of EU Ecolabel compliant combinations.

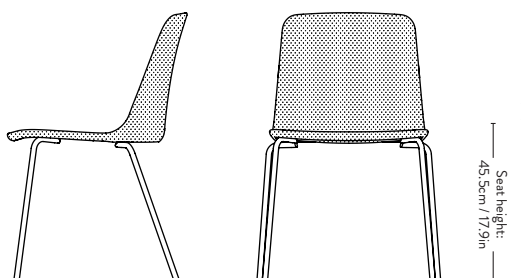

33cm / 12.99in 35.5 cm / 13.98in Seating depth: 45cm / 17.72in

22% RABATT SKA DRAS AV PÅ ANGIVNA PRISER

Rely ^{HW68} Hee Welling 2023



Price group	Upholstery	Model	Base	Lead time	Weight	PRICE EX. VAT (SEK)	PRICE INC. VAT (SEK)
Fabric gr. 1	Hot Madison, Remix, Re-Wool	HW68	Black Chrome NEW	3-6 weeks	7.30 kg	4.652	5.815
Fabric gr. 2	Canvas, Barnum, Fiord, Ritz	HW68	Black Chrome NEW	3-6 weeks	7.30 kg	5.368	6.710
Fabric gr. 3	Clay, Hallingdal, Steelcut Quartet, Steelcut Trio	HW68	Black Chrome NEW	3-6 weeks	7.30 kg	5.604	7.005
Fabric gr. 4	Acca, Cifrado, Ecriture, Moss, Uniform Melange, Vidar	HW68	Black Chrome NEW	3-6 weeks	7.30 kg	6.204	7.755
Fabric gr. 5	Karakorum, Sisu	HW68	Black Chrome NEW	3-6 weeks	7.30 kg	7.636	9.545
Fabric gr. 6	Fuse, Gentle	HW68	Black Chrome NEW	3-6 weeks	7.30 kg	8.712	10.890
Leather	Tailor Semi-aniline leather	HW68	Black Chrome NEW	3-6 weeks	7.30 kg	6.680	8.350
Leather	Noble Aniline leather	HW68	Black Chrome NEW	3-6 weeks	7.30 kg	7.040	8.800
Leather	Elmosoft Semi-aniline leather	HW68	Black Chrome NEW	3-6 weeks	7.30 kg	7.756	9.695
Fabric COM	COM Fabric	HW68	Black Chrome NEW	3-6 weeks	7.30 kg	4.652	5.815
16000000	Rely stacking trolley			2-3 weeks		5.368	6.710

Material: Shell made from 100% recycled polypropylene with fiber glass, covered with HR foam with fabric or leather upholstery, steel tube base.

Fabric usage: 1.4m meters based on a 140cm roll.

Leather usage: 2.2 square meters based on a yield of 60% pr hide.

Wagner QuickClick Plast gliders are installed as standard.

Wagner QuickClick Felt gliders available upon request.

COM must be approved by &Tradition to ensure suitability for upholstery.

Stacking quantity: 8 pcs



EU Ecolabel certified, validating high standards of durability, circular design, and responsible use of chemicals. Please contact our sales team for a list of EU Ecolabel compliant combinations.

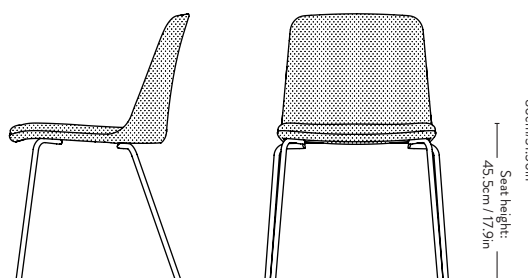

Rely ^{HW69} Hee Welling 2023



Please note that price is accumulated price of shell & seat.

Price group	Shell Upholstery	Model	Base	Lead time	Weight	PRICE EX. VAT (SEK)	PRICE INC. VAT (SEK)
Fabric gr. 1	Hot Madison, Remix, Re-Wool	HW69	Black, Chrome NEW	3-6 weeks	7.30 kg	3.580	4.475
Fabric gr. 2	Canvas, Barnum, Fiord, Ritz	HW69	Black, Chrome NEW	3-6 weeks	7.30 kg	3.940	4.925
Fabric gr. 3	Clay, Hallingdal, Steelcut Quartet, Steelcut Trio	HW69	Black, Chrome NEW	3-6 weeks	7.30 kg	3.932	4.915
Fabric gr. 4	Acca, Cifrado, Ecriture, Moss, Uniform Melange, Vidar	HW69	Black, Chrome NEW	3-6 weeks	7.30 kg	4.176	5.220
Fabric gr. 5	Karakorum, Sisu	HW69	Black, Chrome NEW	3-6 weeks	7.30 kg	5.256	6.570
Fabric gr. 6	Fuse, Gentle	HW69	Black, Chrome NEW	3-6 weeks	7.30 kg	5.732	7.165
Leather	Tailor Semi-aniline leather	HW69	Black, Chrome NEW	3-6 weeks	7.30 kg	4.768	5.960
Leather	Noble Aniline leather	HW69	Black, Chrome NEW	3-6 weeks	7.30 kg	5.012	6.265
Leather	Elmosoft Semi-aniline leather	HW69	Black, Chrome NEW	3-6 weeks	7.30 kg	5.256	6.570
Fabric COM	COM Fabric	HW69	Black, Chrome NEW	3-6 weeks	7.30 kg	3.580	4.475

Price group	Seat Upholstery	Lead time	PRICE EX. VAT (SEK)	PRICE INC. VAT (SEK)
Fabric gr. 1	Hot Madison, Remix, Re-Wool	3-6 weeks	1.196	1.495
Fabric gr. 2	Canvas, Barnum, Fiord, Ritz	3-6 weeks	1.556	1.945
Fabric gr. 3	Clay, Hallingdal, Steelcut Quartet, Steelcut Trio	3-6 weeks	1.676	2.095
Fabric gr. 4	Acca, Cifrado, Ecriture, Moss, Uniform Melange, Vidar	3-6 weeks	2.032	2.540
Fabric gr. 5	Karakorum, Sisu	3-6 weeks	2.512	3.140
Fabric gr. 6	Fuse, Gentle	3-6 weeks	2.752	3.440
Leather	Tailor Semi-aniline leather	3-6 weeks	1.912	2.390
Leather	Noble Aniline leather	3-6 weeks	2.032	2.540
Leather	Elmosoft Semi-aniline leather	3-6 weeks	2.512	3.140
Fabric COM	COM Fabric	3-6 weeks	1.196	1.495
16000000	Rely stacking trolley	2-3 weeks	5.368	6.710

Material: Shell made from 100% recycled polypropylene with fiber glass, HR foam seat covered with fabric or leather upholstery

Fabric usage:

1.9 meter (Shell: 1.2 meters / Seat: 0.7 meter based on a 140 cm roll).

Leather usage: 2.9 square meters (Shell: 2 sqm / Seat: 0.9 sqm).

Wagner QuickClick Plast gliders are installed as standard.
Wagner QuickClick Felt gliders available upon request.
COM must be approved by &Tradition to ensure suitability for upholstery based on a yield of 60% pr hide.
Stacking quantity: 8 pcs

Minimum order quantity of same variant: 4 pcs.

 EU Ecolabel certified, validating high standards of durability, circular design, and responsible use of chemicals.

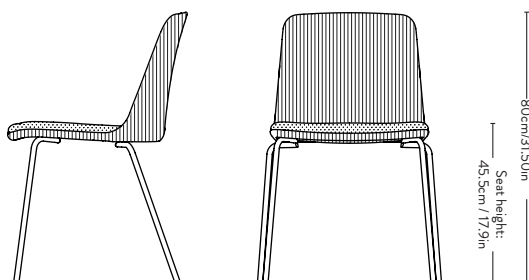

53cm / 20.87in

45cm / 17.7in Seating depth

Please contact our sales team for a list of EU Ecolabel

Rely ^{HW28} Hee Welling 2020



Item code	Shell Colour	Model	Base	Lead time	Weight	PRICE EX. VAT (SEK)	PRICE INC. VAT (SEK)
HW	Black	HW28	Black, Polished Aluminium	2-3 weeks	8.90 kg	4.292	5.365
HW	White	HW28	Black, Polished Aluminium	2-3 weeks	8.90 kg	4.292	5.365
HW	Beige Sand	HW28	Black, Polished Aluminium	2-3 weeks	8.90 kg	4.292	5.365
HW	Red Brown	HW28	Black, Polished Aluminium	2-3 weeks	8.90 kg	4.292	5.365
HW	Light Blue	HW28	Black, Polished Aluminium	2-3 weeks	8.90 kg	4.292	5.365
HW	Stone Grey	HW28	Black, Polished Aluminium	2-3 weeks	8.90 kg	4.292	5.365
HW	Vermilion red	HW28	Black, Polished Aluminium	2-3 weeks	8.90 kg	4.292	5.365
HW	Bronze green	HW28	Black, Polished Aluminium	2-3 weeks	8.90 kg	4.292	5.365
HW	Soft Pink	HW28	Black, Polished Aluminium	2-3 weeks	8.90 kg	4.292	5.365

Material: Shell made from 100% recycled polypropylene with fiber glass, cast aluminium 5-star swivel base w. gaslift & castors.

Castors suitable for all floor types.



EU Ecolabel certified, validating high standards of durability, circular design, and responsible use of chemicals. Please contact our sales team for a list of EU Ecolabel compliant combinations.

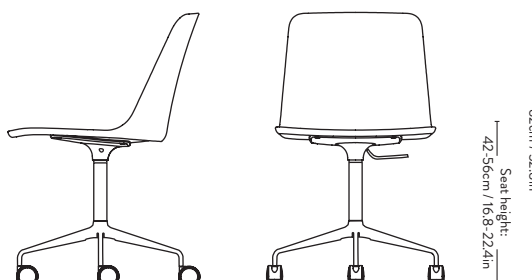

Rely ^{HW29} Hee Welling 2020



Price group	Shell Colour	Seat Cushion Upholstery	Base	Lead time	Weight	PRICE EX. VAT (SEK)	PRICE INC. VAT (SEK)
Fabric gr. 1	Black, White, Beige Sand, Red Brown, Light Blue, Stone Grey, Vermilion red, Bronze green, Soft Pink	Hot Madison, Remix, Re-Wool	Black, Polished Aluminium	3-6 weeks	10.20 kg	5.488	6.860
Fabric gr. 2	Black, White, Beige Sand, Red Brown, Light Blue, Stone Grey, Vermilion red, Bronze green, Soft Pink	Canvas, Barnum, Fiord, Ritz	Black, Polished Aluminium	3-6 weeks	10.20 kg	5.844	7.305
Fabric gr. 3	Black, White, Beige Sand, Red Brown, Light Blue, Stone Grey, Vermilion red, Bronze green, Soft Pink	Clay, Hallingdal, Steelcut Quartet, Steelcut Trio	Black, Polished Aluminium	3-6 weeks	10.20 kg	5.964	7.455
Fabric gr. 4	Black, White, Beige Sand, Red Brown, Light Blue, Stone Grey, Vermilion red, Bronze green, Soft Pink	Acca, Cifrado, Ecriture, Moss, Uniform Melange, Vidar	Black, Polished Aluminium	3-6 weeks	10.20 kg	6.324	7.905
Fabric gr. 5	Black, White, Beige Sand, Red Brown, Light Blue, Stone Grey, Vermilion red, Bronze green, Soft Pink	Karakorum, Sisu	Black, Polished Aluminium	3-6 weeks	10.20 kg	6.800	8.500
Fabric gr. 6	Black, White, Beige Sand, Red Brown, Light Blue, Stone Grey, Vermilion red, Bronze green, Soft Pink	Fuse, Gentle	Black, Polished Aluminium	3-6 weeks	10.20 kg	7.636	9.545
Leather	Black, White, Beige Sand, Red Brown, Light Blue, Stone Grey, Vermilion red, Bronze green, Soft Pink	Tailor Semi-aniline leather	Black, Polished Aluminium	3-6 weeks	10.20 kg	5.964	7.455
Leather	Black, White, Beige Sand, Red Brown, Light Blue, Stone Grey, Vermilion red, Bronze green, Soft Pink	Noble Aniline leather	Black, Polished Aluminium	3-6 weeks	10.20 kg	6.324	7.905
Leather	Black, White, Beige Sand, Red Brown, Light Blue, Stone Grey, Vermilion red, Bronze green, Soft Pink	Elmosoft Semi-aniline leather	Black, Polished Aluminium	3-6 weeks	10.20 kg	6.680	8.350
Fabric COM	Black, White, Beige Sand, Red Brown, Light Blue, Stone Grey, Vermilion red, Bronze green, Soft Pink	COM Fabric	Black, Polished Aluminium	3-6 weeks	10.20 kg	5.488	6.860



EU Ecolabel certified, validating high standards of durability, circular design, and responsible use of chemicals. Please contact our sales team for a list of EU Ecolabel compliant combinations.

Material: Shell made from 100% recycled polypropylene with fiber glass, seat covered in HR foam with fabric or leather upholstery, cast aluminium 5-star swivel base w. gaslift & castors.

Castors suitable for all floor types.

Fabric usage: 0.49 meter based on a 140 cm roll.

Leather usage: 1 square meter based on a yield of 60% pr hide.

COM must be approved by &Tradition to ensure suitability for upholstery.

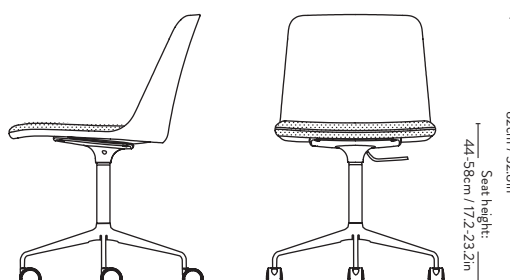

Rely^{HW30} Hee Welling 2020



Price group	Upholstery	Model	Base	Lead time	Weight	PRICE EX. VAT (SEK)	PRICE INC. VAT (SEK)
Fabric gr. 1	Hot Madison, Remix, Re-Wool	HW30	Black, Polished Aluminium	3-6 weeks	8.90 kg	6.204	7.755
Fabric gr. 2	Canvas, Barnum, Fiord, Ritz	HW30	Black, Polished Aluminium	3-6 weeks	8.90 kg	6.920	8.650
Fabric gr. 3	Clay, Hallingdal, Steelcut Quartet, Steelcut Trio	HW30	Black, Polished Aluminium	3-6 weeks	8.90 kg	7.160	8.950
Fabric gr. 4	Acca, Cifrado, Ecriture, Moss, Uniform Melange, Vidar	HW30	Black, Polished Aluminium	3-6 weeks	8.90 kg	7.756	9.695
Fabric gr. 5	Karakorum, Sisu	HW30	Black, Polished Aluminium	3-6 weeks	8.90 kg	9.188	11.485
Fabric gr. 6	Fuse, Gentle	HW30	Black, Polished Aluminium	3-6 weeks	8.90 kg	10.024	12.530
Leather	Tailor Semi-aniline leather	HW30	Black, Polished Aluminium	3-6 weeks	8.90 kg	8.112	10.140
Leather	Noble Aniline leather	HW30	Black, Polished Aluminium	3-6 weeks	8.90 kg	8.472	10.590
Leather	Elmosoft Semi-aniline leather	HW30	Black, Polished Aluminium	3-6 weeks	8.90 kg	9.068	11.335
Fabric COM	COM Fabric	HW30	Black, Polished Aluminium	3-6 weeks	8.90 kg	6.204	7.755

Material: Shell made from 100% recycled polypropylene with fiber glass, covered in HR foam with fabric or leather upholstery, cast aluminium 5-star swivel base w. gaslift & castors.

Castors suitable for all floor types.

Fabric usage: 1.40 meters based on a 140cm roll.

Leather usage: 2.2 square meters based on a yield of 60% pr hide.

COM must be approved by Tradition to ensure suitability for upholstery.



EU Ecolabel certified, validating high standards of durability, circular design, and responsible use of chemicals. Please contact our sales team for a list of EU Ecolabel compliant combinations.

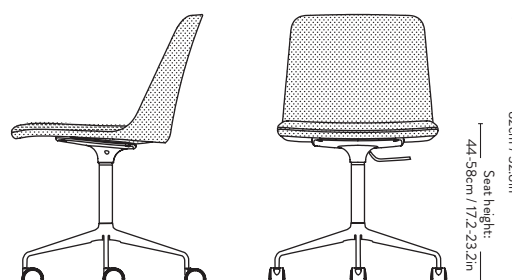

Rely^{HW31} Hee Welling 2020



Price group	Upholstery	Model	Base	Lead time	Weight	PRICE EX. VAT (SEK)	PRICE INC. VAT (SEK)
Fabric gr. 1	Hot Madison, Remix, Re-Wool	HW31	Black, Polished Aluminium	3-6 weeks	10.50 kg	6.440	8.050
Fabric gr. 2	Canvas, Barnum, Fiord, Ritz	HW31	Black, Polished Aluminium	3-6 weeks	10.50 kg	7.160	8.950
Fabric gr. 3	Clay, Hallingdal, Steelcut Quartet, Steelcut Trio	HW31	Black, Polished Aluminium	3-6 weeks	10.50 kg	7.396	9.245
Fabric gr. 4	Acca, Cifrado, Ecriture, Moss, Uniform Melange, Vidar	HW31	Black, Polished Aluminium	3-6 weeks	10.50 kg	7.996	9.995
Fabric gr. 5	Karakorum, Sisu	HW31	Black, Polished Aluminium	3-6 weeks	10.50 kg	9.428	11.785
Fabric gr. 6	Fuse, Gentle	HW31	Black, Polished Aluminium	3-6 weeks	10.50 kg	10.384	12.980
Leather	Tailor Semi-aniline leather	HW31	Black, Polished Aluminium	3-6 weeks	10.50 kg	8.352	10.440
Leather	Noble Aniline leather	HW31	Black, Polished Aluminium	3-6 weeks	10.50 kg	8.712	10.890
Leather	Elmosoft Semi-aniline leather	HW31	Black, Polished Aluminium	3-6 weeks	10.50 kg	9.548	11.935
Fabric COM	COM Fabric	HW31	Black, Polished Aluminium	3-6 weeks	10.50 kg	6.440	8.050

Material: Shell made from 100% recycled polypropylene with fiber glass, covered in HR foam with fabric or leather upholstery, cast aluminium 5-star swivel base w. gaslift & castors.

Castors suitable for all floor types.

Fabric usage: 1.8 meters based on a 140cm roll.

Leather usage: 2.7 square meters based on a yield of 60% pr hide.

COM must be approved by &Tradition to ensure suitability for upholstery.



EU Ecolabel certified, validating high standards of durability, circular design, and responsible use of chemicals. Please contact our sales team for a list of EU Ecolabel compliant combinations.

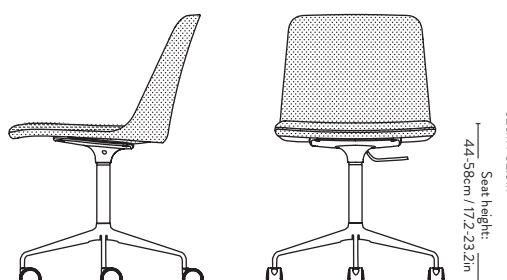

Rely ^{HW32} Hee Welling 2020



Please note that price is accumulated price of shell & seat.

Price group	Shell Upholstery	Base	Lead time	Weight	PRICE EX. VAT (SEK)	PRICE INC. VAT (SEK)
Fabric gr. 1	Hot Madison, Remix, Re-Wool	Black, Polished Aluminium	3-6 weeks	10.50 kg	5.244	6.555
Fabric gr. 2	Canvas, Barnum, Fiord, Ritz	Black, Polished Aluminium	3-6 weeks	10.50 kg	5.608	7.010
Fabric gr. 3	Clay, Hallingdal, Steelcut Quartet, Steelcut Trio	Black, Polished Aluminium	3-6 weeks	10.50 kg	5.732	7.165
Fabric gr. 4	Acca, Cifrado, Ecriture, Moss, Uniform Melange, Vidar	Black, Polished Aluminium	3-6 weeks	10.50 kg	5.968	7.460
Fabric gr. 5	Karakorum, Sisu	Black, Polished Aluminium	3-6 weeks	10.50 kg	6.928	8.660
Fabric gr. 6	Fuse, Gentle	Black, Polished Aluminium	3-6 weeks	10.50 kg	7.648	9.560
Leather	Tailor Semi-aniline leather	Black, Polished Aluminium	3-6 weeks	10.50 kg	6.452	8.065
Leather	Noble Aniline leather	Black, Polished Aluminium	3-6 weeks	10.50 kg	6.684	8.355
Leather	Elmosoft Semi-aniline leather	Black, Polished Aluminium	3-6 weeks	10.50 kg	7.048	8.810
Fabric COM	COM Fabric	Black, Polished Aluminium	3-6 weeks	10.50 kg	5.244	6.555

Price group	Seat Upholstery	Lead time	PRICE EX. VAT (SEK)	PRICE INC. VAT (SEK)
Fabric gr. 1	Hot Madison, Remix, Re-Wool	3-6 weeks	1.196	1.495
Fabric gr. 2	Canvas, Barnum, Fiord, Ritz	3-6 weeks	1.556	1.945
Fabric gr. 3	Clay, Hallingdal, Steelcut Quartet, Steelcut Trio	3-6 weeks	1.676	2.095
Fabric gr. 4	Acca, Cifrado, Ecriture, Moss, Uniform Melange, Vidar	3-6 weeks	2.032	2.540
Fabric gr. 5	Karakorum, Sisu	3-6 weeks	2.512	3.140
Fabric gr. 6	Fuse, Gentle	3-6 weeks	2.752	3.440
Leather	Tailor Semi-aniline leather	3-6 weeks	1.912	2.390
Leather	Noble Aniline leather	3-6 weeks	2.032	2.540
Leather	Elmosoft Semi-aniline leather	3-6 weeks	2.512	3.140
Fabric COM	COM Fabric	3-6 weeks	1.196	1.495

Material: Shell made from 100% recycled polypropylene with fiber glass, covered in HR foam with fabric or leather upholstery, cast aluminium 5-star swivel base w. gaslift & castors.

Castors suitable for all floor types.

Fabric usage: 1.9 meter (Shell: 1.2 meters / Seat: 0.7 meter).

Leather usage: 2.9 square meters (Shell: 2 sqm / Seat: 0.9 sqm) based on a yield of 60% pr hide.

COM must be approved by &Tradition to ensure suitability for upholstery.

Minimum order quantity of same variant: 4 pcs.



EU Ecolabel certified, validating high standards of durability, circular design, and responsible use of chemicals. Please contact our sales team for a list of EU Ecolabel compliant combinations.

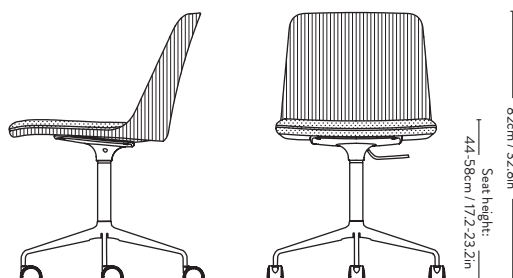

Rely ^{HW33} Hee Welling 2021



Item code	Shell Colour	Model	Base	Colli qty.	Lead time	Weight	PRICE EX. VAT (SEK)	PRICE INC. VAT (SEK)
HW	Black	HW33	Black, Bronzed, Chrome	1 pc 4 pcs	2-3 weeks	6.90 kg	2.500 2.384	3.125 2.980
HW	White	HW33	Black, Bronzed, Chrome	1 pc 4 pcs	2-3 weeks	6.90 kg	2.500 2.384	3.125 2.980
HW	Beige Sand	HW33	Black, Bronzed, Chrome	1 pc 4 pcs	2-3 weeks	6.90 kg	2.500 2.384	3.125 2.980
HW	Red Brown	HW33	Black, Bronzed, Chrome	1 pc 4 pcs	2-3 weeks	6.90 kg	2.500 2.384	3.125 2.980
HW	Light Blue	HW33	Black, Bronzed, Chrome	1 pc 4 pcs	2-3 weeks	6.90 kg	2.500 2.384	3.125 2.980
HW	Stone Grey	HW33	Black, Bronzed, Chrome	1 pc 4 pcs	2-3 weeks	6.90 kg	2.500 2.384	3.125 2.980
HW	Vermilion red	HW33	Black, Bronzed, Chrome	1 pc 4 pcs	2-3 weeks	6.90 kg	2.500 2.384	3.125 2.980
HW	Bronze green	HW33	Black, Bronzed, Chrome	1 pc 4 pcs	2-3 weeks	6.90 kg	2.500 2.384	3.125 2.980
HW	Soft Pink	HW33	Black, Bronzed, Chrome	1 pc 4 pcs	2-3 weeks	6.90 kg	2.500 2.384	3.125 2.980

Material: Shell made from 100% recycled polypropylene with fiber glass and a steel tube base.

Wagner QuickClick Plast gliders are installed as standard.
Wagner QuickClick Felt gliders available upon request.



EU Ecolabel certified, validating high standards of durability, circular design, and responsible use of chemicals. Please contact our sales team for a list of EU Ecolabel compliant combinations.

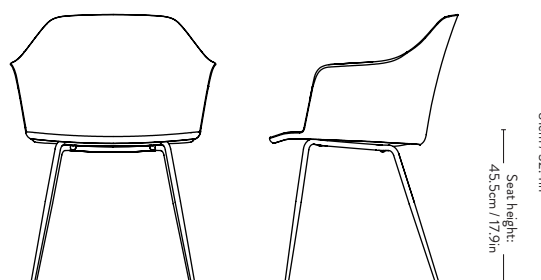

60.8cm / 23.9in 58.5cm / 22.6in Armrest height: 67.3cm / 26.7in

22% RABATT SKA DRAS AV PÅ ANGIVNA PRISER

Rely^{HW34} Hee Welling 2021



Price group	Shell Colour	Seat Cushion Upholstery	Model	Base	Lead time	Weight	PRICE EX. VAT (SEK)	PRICE INC. VAT (SEK)
Fabric gr. 1	Black, White, Beige Sand, Red Brown, Light Blue, Stone Grey, Vermilion red, Bronze green, Soft Pink	Hot Madison, Remix, Re-Wool	HW34	Black, Bronzed, Chrome	3-6 weeks	8.10 kg	3.936	4.920
Fabric gr. 2	Black, White, Beige Sand, Red Brown, Light Blue, Stone Grey, Vermilion red, Bronze green, Soft Pink	Canvas, Barnum, Fiord, Ritz	HW34	Black, Bronzed, Chrome	3-6 weeks	8.10 kg	4.292	5.365
Fabric gr. 3	Black, White, Beige Sand, Red Brown, Light Blue, Stone Grey, Vermilion red, Bronze green, Soft Pink	Clay, Hallingdal, Steelcut Quartet, Steelcut Trio	HW34	Black, Bronzed, Chrome	3-6 weeks	8.10 kg	4.412	5.515
Fabric gr. 4	Black, White, Beige Sand, Red Brown, Light Blue, Stone Grey, Vermilion red, Bronze green, Soft Pink	Acca, Cifrado, Ecriture, Moss, Uniform Melange, Vidar	HW34	Black, Bronzed, Chrome	3-6 weeks	8.10 kg	4.772	5.965
Fabric gr. 5	Black, White, Beige Sand, Red Brown, Light Blue, Stone Grey, Vermilion red, Bronze green, Soft Pink	Karakorum, Sisu	HW34	Black, Bronzed, Chrome	3-6 weeks	8.10 kg	5.248	6.560
Fabric gr. 6	Black, White, Beige Sand, Red Brown, Light Blue, Stone Grey, Vermilion red, Bronze green, Soft Pink	Fuse, Gentle	HW34	Black, Bronzed, Chrome	3-6 weeks	8.10 kg	5.724	7.155
Leather	Black, White, Beige Sand, Red Brown, Light Blue, Stone Grey, Vermilion red, Bronze green, Soft Pink	Tailor Semi-aniline leather	HW34	Black, Bronzed, Chrome	3-6 weeks	8.10 kg	4.412	5.515
Leather	Black, White, Beige Sand, Red Brown, Light Blue, Stone Grey, Vermilion red, Bronze green, Soft Pink	Noble Aniline leather	HW34	Black, Bronzed, Chrome	3-6 weeks	8.10 kg	4.772	5.965
Leather	Black, White, Beige Sand, Red Brown, Light Blue, Stone Grey, Vermilion red, Bronze green, Soft Pink	Elmosoft Semi-aniline leather	HW34	Black, Bronzed, Chrome	3-6 weeks	8.10 kg	5.128	6.410
Fabric COM	Black, White, Beige Sand, Red Brown, Light Blue, Stone Grey, Vermilion red, Bronze green, Soft Pink	COM Fabric	HW34	Black, Bronzed, Chrome	3-6 weeks	8.10 kg	3.936	4.920



EU Ecolabel certified, validating high standards of durability, circular design, and responsible use of chemicals. Please contact our sales team for a list of EU Ecolabel compliant combinations.

Material: Shell made from 100% recycled polypropylene with fiber glass, HR foam seat covered with fabric or leather upholstery, steel tube base.

Fabric usage: 0.49 meter based on a 140 cm roll.

Leather usage: 1 square meter based on a yield of 60% pr hide.

COM must be approved by &Tradition to ensure suitability for upholstery.

Wagner QuickClick Plast gliders are installed as standard.

Wagner QuickClick Felt gliders available upon request.

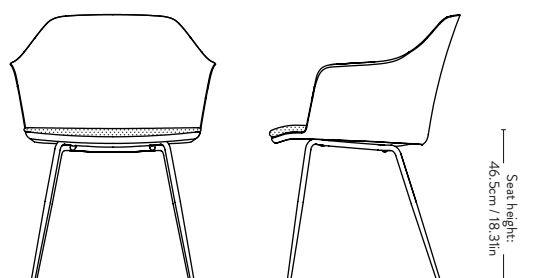

Rely^{HW35} Hee Welling 2021



Price group	Upholstery	Model	Base	Lead time	Weight	PRICE EX. VAT (SEK)	PRICE INC. VAT (SEK)
Fabric gr. 1	Hot Madison, Remix, Re-Wool	HW35	Black, Bronzed, Chrome	3-6 weeks	7.30 kg	5.128	6.410
Fabric gr. 2	Canvas, Barnum, Fiord, Ritz	HW35	Black, Bronzed, Chrome	3-6 weeks	7.30 kg	5.844	7.305
Fabric gr. 3	Clay, Hallingdal, Steelcut Quartet, Steelcut Trio	HW35	Black, Bronzed, Chrome	3-6 weeks	7.30 kg	6.084	7.605
Fabric gr. 4	Acca, Cifrado, Ecriture, Moss, Uniform Melange, Vidar	HW35	Black, Bronzed, Chrome	3-6 weeks	7.30 kg	6.800	8.500
Fabric gr. 5	Karakorum, Sisu	HW35	Black, Bronzed, Chrome	3-6 weeks	7.30 kg	8.232	10.290
Fabric gr. 6	Fuse, Gentle	HW35	Black, Bronzed, Chrome	3-6 weeks	7.30 kg	9.068	11.335
Leather	Tailor Semi-aniline leather	HW35	Black, Bronzed, Chrome	3-6 weeks	7.30 kg	7.160	8.950
Leather	Noble Aniline leather	HW35	Black, Bronzed, Chrome	3-6 weeks	7.30 kg	8.592	10.740
Leather	Elmosoft Semi-aniline leather	HW35	Black, Bronzed, Chrome	3-6 weeks	7.30 kg	9.428	11.785
Fabric COM	COM Fabric	HW35	Black, Bronzed, Chrome	3-6 weeks	7.30 kg	5.128	6.410

Material: Shell made from 100% recycled polypropylene with fiber glass, covered with HR foam with fabric or leather upholstery, steel tube base.

Fabric usage: 1.5 meters based on 140cm roll.

Leather usage: 2.7 square meters based on a yield of 60% pr hide.

COM must be approved by &Tradition to ensure suitability for upholstery.

Wagner QuickClick Plast gliders are installed as standard.

Wagner QuickClick Felt gliders available upon request.



EU Ecolabel certified, validating high standards of durability, circular design, and responsible use of chemicals. Please contact our sales team for a list of EU Ecolabel compliant combinations.

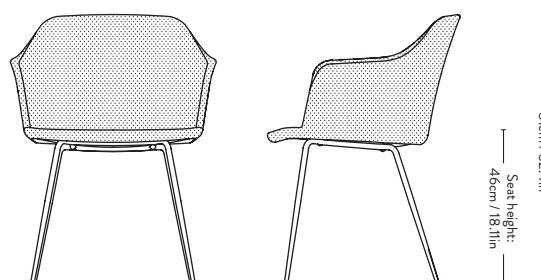

60.8cm / 23.9in

56.5cm / 22.6in

Armrest height

67.3cm / 26.5in

22% RABATT SKA DRAS AV PÅ ANGIVNA PRISER

Rely^{HW36} Hee Welling 2021



Price group	Upholstery	Model	Base	Lead time	Weight	PRICE EX. VAT (SEK)	PRICE INC. VAT (SEK)
Fabric gr. 1	Hot Madison, Remix, Re-Wool	HW36	Black, Bronzed, Chrome	3-6 weeks	8.40 kg	5.488	6.860
Fabric gr. 2	Canvas, Barnum, Fiord, Ritz	HW36	Black, Bronzed, Chrome	3-6 weeks	8.40 kg	6.204	7.755
Fabric gr. 3	Clay, Hallingdal, Steelcut Quartet, Steelcut Trio	HW36	Black, Bronzed, Chrome	3-6 weeks	8.40 kg	6.440	8.050
Fabric gr. 4	Acca, Cifrado, Ecriture, Moss, Uniform Melange, Vidar	HW36	Black, Bronzed, Chrome	3-6 weeks	8.40 kg	7.160	8.950
Fabric gr. 5	Karakorum, Sisu	HW36	Black, Bronzed, Chrome	3-6 weeks	8.40 kg	8.592	10.740
Fabric gr. 6	Fuse, Gentle	HW36	Black, Bronzed, Chrome	3-6 weeks	8.40 kg	9.428	11.785
Leather	Tailor Semi-aniline leather	HW36	Black, Bronzed, Chrome	3-6 weeks	8.40 kg	7.516	9.395
Leather	Noble Aniline leather	HW36	Black, Bronzed, Chrome	3-6 weeks	8.40 kg	8.948	11.185
Leather	Elmosoft Semi-aniline leather	HW36	Black, Bronzed, Chrome	3-6 weeks	8.40 kg	10.024	12.530
Fabric COM	COM Fabric	HW36	Black, Bronzed, Chrome	3-6 weeks	8.40 kg	5.488	6.860

Material: Shell made from 100% recycled polypropylene with fiber glass, covered with HR foam with fabric or leather upholstery, steel tube base.

Fabric usage: 2.3 meters based on 140cm roll.

Leather usage: 3.4 square meters based on a yield of 60% pr hide.

COM must be approved by &Tradition to ensure suitability for upholstery.

Wagner QuickClick Plast gliders are installed as standard.

Wagner QuickClick Felt gliders available upon request.



EU Ecolabel certified, validating high standards of durability, circular design, and responsible use of chemicals. Please contact our sales team for a list of EU Ecolabel compliant combinations.

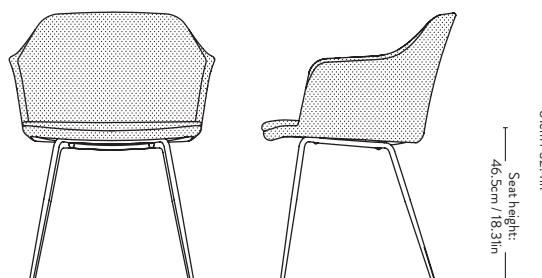

Rely ^{HW37} Hee Welling 2021



Please note that price is accumulated price of shell & seat.

Price group	Shell Upholstery	Base	Lead time	Weight	PRICE EX. VAT (SEK)	PRICE INC. VAT (SEK)
Fabric gr. 1	Hot Madison, Remix, Re-Wool	Black, Bronzed, Chrome	3-6 weeks	8.40 kg	4.300	5.375
Fabric gr. 2	Canvas, Barnum, Fiord, Ritz	Black, Bronzed, Chrome	3-6 weeks	8.40 kg	4.656	5.820
Fabric gr. 3	Clay, Hallingdal, Steelcut Quartet, Steelcut Trio	Black, Bronzed, Chrome	3-6 weeks	8.40 kg	4.768	5.960
Fabric gr. 4	Acca, Cifrado, Ecriture, Moss, Uniform Melange, Vidar	Black, Bronzed, Chrome	3-6 weeks	8.40 kg	5.132	6.415
Fabric gr. 5	Karakorum, Sisu	Black, Bronzed, Chrome	3-6 weeks	8.40 kg	6.092	7.615
Fabric gr. 6	Fuse, Gentle	Black, Bronzed, Chrome	3-6 weeks	8.40 kg	6.692	8.365
Leather	Tailor Semi-aniline leather	Black, Bronzed, Chrome	3-6 weeks	8.40 kg	5.616	7.020
Leather	Noble Aniline leather	Black, Bronzed, Chrome	3-6 weeks	8.40 kg	6.928	8.660
Leather	Elmosoft Semi-aniline leather	Black, Bronzed, Chrome	3-6 weeks	8.40 kg	7.528	9.410
Fabric COM	COM Fabric	Black, Bronzed, Chrome	3-6 weeks	8.40 kg	4.300	5.375

Price group	Seat Upholstery	Lead time	PRICE EX. VAT (SEK)	PRICE INC. VAT (SEK)
Fabric gr. 1	Hot Madison, Remix, Re-Wool	3-6 weeks	1.196	1.495
Fabric gr. 2	Canvas, Barnum, Fiord, Ritz	3-6 weeks	1.556	1.945
Fabric gr. 3	Clay, Hallingdal, Steelcut Quartet, Steelcut Trio	3-6 weeks	1.676	2.095
Fabric gr. 4	Acca, Cifrado, Ecriture, Moss, Uniform Melange, Vidar	3-6 weeks	2.032	2.540
Fabric gr. 5	Karakorum, Sisu	3-6 weeks	2.512	3.140
Fabric gr. 6	Fuse, Gentle	3-6 weeks	2.752	3.440
Leather	Tailor Semi-aniline leather	3-6 weeks	1.912	2.390
Leather	Noble Aniline leather	3-6 weeks	2.032	2.540
Leather	Elmosoft Semi-aniline leather	3-6 weeks	2.512	3.140
Fabric COM	COM Fabric	3-6 weeks	1.196	1.495

Material: Shell made from 100% recycled polypropylene with fiber glass, covered with HR foam with fabric or leather upholstery, steel tube base.

Fabric usage: 1.5 meters (shell), 0.77 meters (cushion) based on 140cm roll.
Leather usage: 2.64 square meters (shell), 0.77 square meters (cushion) based on a yield of 60% pr hide.

COM must be approved by &Tradition to ensure suitability for upholstery.

Wagner QuickClick Plast gliders are installed as standard.
Wagner QuickClick Felt gliders available upon request.

Minimum order quantity of same variant: 4 pcs.



EU Ecolabel certified, validating high standards of durability, circular design, and responsible use of chemicals. Please contact our sales team for a list of EU Ecolabel compliant combinations.

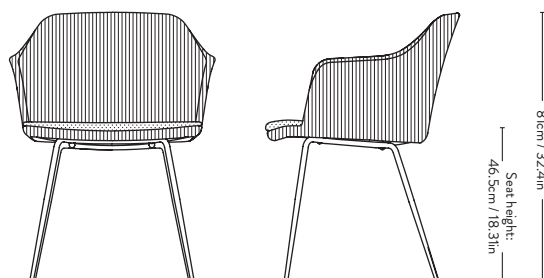

60.8cm / 23.9in

60.5cm / 23.8in

Armrest height: 67.5cm / 26.6in

Rely ^{HW38} Hee Welling 2021



Item code	Shell Colour	Model	Base	Lead time	Weight	PRICE EX. VAT (SEK)	PRICE INC. VAT (SEK)
HW	Black	HW38	Black, Bronzed, Polished Aluminium	2-3 weeks	9.40 kg	3.336	4.170
HW	White	HW38	Black, Bronzed, Polished Aluminium	2-3 weeks	9.40 kg	3.336	4.170
HW	Beige Sand	HW38	Black, Bronzed, Polished Aluminium	2-3 weeks	9.40 kg	3.336	4.170
HW	Red Brown	HW38	Black, Bronzed, Polished Aluminium	2-3 weeks	9.40 kg	3.336	4.170
HW	Light Blue	HW38	Black, Bronzed, Polished Aluminium	2-3 weeks	9.40 kg	3.336	4.170
HW	Stone Grey	HW38	Black, Bronzed, Polished Aluminium	2-3 weeks	9.40 kg	3.336	4.170
HW	Vermilion red	HW38	Black, Bronzed, Polished Aluminium	2-3 weeks	9.40 kg	3.336	4.170
HW	Bronze green	HW38	Black, Bronzed, Polished Aluminium	2-3 weeks	9.40 kg	3.336	4.170
HW	Soft Pink	HW38	Black, Bronzed, Polished Aluminium	2-3 weeks	9.40 kg	3.336	4.170

Material: Shell made from 100% recycled polypropylene with fiber glass and an aluminium swivel base.

Plastic gliders installed as standard.
Felt gliders available upon request.



EU Ecolabel certified, validating high standards of durability, circular design, and responsible use of chemicals. Please contact our sales team for a list of EU Ecolabel compliant combinations.

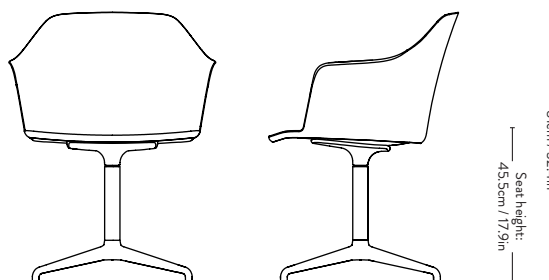

Rely ^{HW39} Hee Welling 2021



Price group	Shell Colour	Seat Cushion Upholstery	Base	Lead time	Weight	PRICE EX. VAT (SEK)	PRICE INC. VAT (SEK)
Fabric gr. 1	Black, White, Beige Sand, Red Brown, Light Blue, Stone Grey, Vermilion red, Bronze green, Soft Pink	Hot Madison, Remix, Re-Wool	Black, Bronzed, Polished Aluminium	3-6 weeks	10.70 kg	5.008	6.260
Fabric gr. 2	Black, White, Beige Sand, Red Brown, Light Blue, Stone Grey, Vermilion red, Bronze green, Soft Pink	Canvas, Barnum, Fiord, Ritz	Black, Bronzed, Polished Aluminium	3-6 weeks	10.70 kg	5.368	6.710
Fabric gr. 3	Black, White, Beige Sand, Red Brown, Light Blue, Stone Grey, Vermilion red, Bronze green, Soft Pink	Clay, Hallingdal, Steelcut Quartet, Steelcut Trio	Black, Bronzed, Polished Aluminium	3-6 weeks	10.70 kg	5.488	6.860
Fabric gr. 4	Black, White, Beige Sand, Red Brown, Light Blue, Stone Grey, Vermilion red, Bronze green, Soft Pink	Acca, Cifrado, Ecriture, Moss, Uniform Melange, Vidar	Black, Bronzed, Polished Aluminium	3-6 weeks	10.70 kg	5.844	7.305
Fabric gr. 5	Black, White, Beige Sand, Red Brown, Light Blue, Stone Grey, Vermilion red, Bronze green, Soft Pink	Karakorum, Sisu	Black, Bronzed, Polished Aluminium	3-6 weeks	10.70 kg	6.324	7.905
Fabric gr. 6	Black, White, Beige Sand, Red Brown, Light Blue, Stone Grey, Vermilion red, Bronze green, Soft Pink	Fuse, Gentle	Black, Bronzed, Polished Aluminium	3-6 weeks	10.70 kg	6.920	8.650
Leather	Black, White, Beige Sand, Red Brown, Light Blue, Stone Grey, Vermilion red, Bronze green, Soft Pink	Tailor Semi-aniline leather	Black, Bronzed, Polished Aluminium	3-6 weeks	10.70 kg	5.488	6.860
Leather	Black, White, Beige Sand, Red Brown, Light Blue, Stone Grey, Vermilion red, Bronze green, Soft Pink	Noble Aniline leather	Black, Bronzed, Polished Aluminium	3-6 weeks	10.70 kg	5.844	7.305
Leather	Black, White, Beige Sand, Red Brown, Light Blue, Stone Grey, Vermilion red, Bronze green, Soft Pink	Elmosoft Semi-aniline leather	Black, Bronzed, Polished Aluminium	3-6 weeks	10.70 kg	6.204	7.755
Fabric COM	Black, White, Beige Sand, Red Brown, Light Blue, Stone Grey, Vermilion red, Bronze green, Soft Pink	COM Fabric	Black, Bronzed, Polished Aluminium	3-6 weeks	10.70 kg	5.008	6.260

Material: Shell made from 100% recycled polypropylene with fiber glass, HR foam seat covered with fabric or leather upholstery, aluminium swivel base.

Fabric usage: 0.49 meter based on a 140 cm roll.

Leather usage: 1 square meter based on a yield of 60% pr hide.

COM must be approved by &Tradition to ensure suitability for upholstery.

Plastic gliders installed as standard.

Felt gliders available upon request.

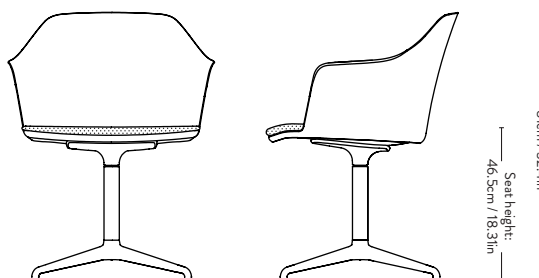

Rely^{HW40} Hee Welling 2021



Price group	Upholstery	Model	Base	Lead time	Weight	PRICE EX. VAT (SEK)	PRICE INC. VAT (SEK)
Fabric gr. 1	Hot Madison, Remix, Re-Wool	HW40	Black, Bronzed, Polished Aluminium	3-6 weeks	9.90 kg	5.964	7.455
Fabric gr. 2	Canvas, Barnum, Fiord, Ritz	HW40	Black, Bronzed, Polished Aluminium	3-6 weeks	9.90 kg	6.680	8.350
Fabric gr. 3	Clay, Hallingdal, Steelcut Quartet, Steelcut Trio	HW40	Black, Bronzed, Polished Aluminium	3-6 weeks	9.90 kg	6.920	8.650
Fabric gr. 4	Acca, Cifrado, Ecriture, Moss, Uniform Melange, Vidar	HW40	Black, Bronzed, Polished Aluminium	3-6 weeks	9.90 kg	7.636	9.545
Fabric gr. 5	Karakorum, Sisu	HW40	Black, Bronzed, Polished Aluminium	3-6 weeks	9.90 kg	9.068	11.335
Fabric gr. 6	Fuse, Gentle	HW40	Black, Bronzed, Polished Aluminium	3-6 weeks	9.90 kg	10.144	12.680
Leather	Tailor Semi-aniline leather	HW40	Black, Bronzed, Polished Aluminium	3-6 weeks	9.90 kg	7.996	9.995
Leather	Noble Aniline leather	HW40	Black, Bronzed, Polished Aluminium	3-6 weeks	9.90 kg	9.428	11.785
Leather	Elmosoft Semi-aniline leather	HW40	Black, Bronzed, Polished Aluminium	3-6 weeks	9.90 kg	10.264	12.830
Fabric COM	COM Fabric	HW40	Black, Bronzed, Polished Aluminium	3-6 weeks	9.90 kg	5.964	7.455

Material: Shell made from 100% recycled polypropylene with fiber glass, covered with HR foam with fabric or leather upholstery, aluminium swivel base.

Fabric usage: 1.5 meters based on 140cm roll.

Leather usage: 2.7 square meters based on a yield of 60% pr hide.

Plastic gliders installed as standard.

Felt gliders available upon request.

COM must be approved by &Tradition to ensure suitability for upholstery.

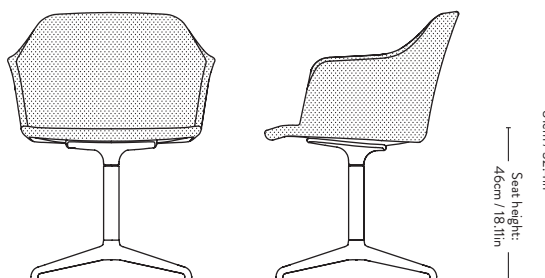

Rely^{HW41} Hee Welling 2021



Price group	Upholstery	Model	Base	Lead time	Weight	PRICE EX. VAT (SEK)	PRICE INC. VAT (SEK)
Fabric gr. 1	Hot Madison, Remix, Re-Wool	HW41	Black, Bronzed, Polished Aluminium	3-6 weeks	11.00 kg	6.324	7.905
Fabric gr. 2	Canvas, Barnum, Fiord, Ritz	HW41	Black, Bronzed, Polished Aluminium	3-6 weeks	11.00 kg	7.040	8.800
Fabric gr. 3	Clay, Hallingdal, Steelcut Quartet, Steelcut Trio	HW41	Black, Bronzed, Polished Aluminium	3-6 weeks	11.00 kg	7.276	9.095
Fabric gr. 4	Acca, Cifrado, Ecriture, Moss, Uniform Melange, Vidar	HW41	Black, Bronzed, Polished Aluminium	3-6 weeks	11.00 kg	7.996	9.995
Fabric gr. 5	Karakorum, Sisu	HW41	Black, Bronzed, Polished Aluminium	3-6 weeks	11.00 kg	9.428	11.785
Fabric gr. 6	Fuse, Gentle	HW41	Black, Bronzed, Polished Aluminium	3-6 weeks	11.00 kg	10.384	12.980
Leather	Tailor Semi-aniline leather	HW41	Black, Bronzed, Polished Aluminium	3-6 weeks	11.00 kg	8.352	10.440
Leather	Noble Aniline leather	HW41	Black, Bronzed, Polished Aluminium	3-6 weeks	11.00 kg	9.784	12.230
Leather	Elmosoft Semi-aniline leather	HW41	Black, Bronzed, Polished Aluminium	3-6 weeks	11.00 kg	10.860	13.575
Fabric COM	COM Fabric	HW41	Black, Bronzed, Polished Aluminium	3-6 weeks	11.00 kg	6.324	7.905

Material: Shell made from 100% recycled polypropylene with fiber glass, covered with HR foam with fabric or leather upholstery, aluminium swivel base.

Fabric usage: 2.3 meters based on 140cm roll.

Leather usage: 3.4 square meters based on a yield of 60% pr hide.

Plastic gliders installed as standard.

Felt gliders available upon request.

COM must be approved by &Tradition to ensure suitability for upholstery.

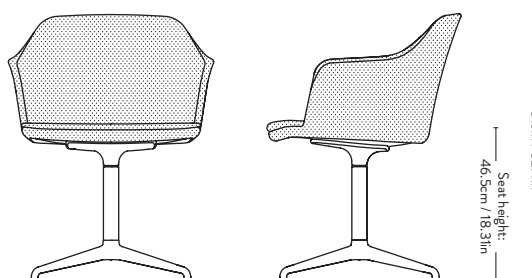

60.8cm / 23.9in 56.5cm / 22.6in Armrest height: 47.3cm / 18.6in

22% RABATT SKA DRAS AV PÅ ANGIVNA PRISER

Rely^{HW42} Hee Welling 2021



Please note that price is accumulated price of shell & seat.

Price group	Shell Upholstery	Base	Lead time	Weight	PRICE EX. VAT (SEK)	PRICE INC. VAT (SEK)
Fabric gr. 1	Hot Madison, Remix, Re-Wool	Black, Bronzed, Polished Aluminium	3-6 weeks	11.00 kg	5.136	6.420
Fabric gr. 2	Canvas, Barnum, Fiord, Ritz	Black, Bronzed, Polished Aluminium	3-6 weeks	11.00 kg	5.496	6.870
Fabric gr. 3	Clay, Hallingdal, Steelcut Quartet, Steelcut Trio	Black, Bronzed, Polished Aluminium	3-6 weeks	11.00 kg	5.616	7.020
Fabric gr. 4	Acca, Cifrado, Ecriture, Moss, Uniform Melange, Vidar	Black, Bronzed, Polished Aluminium	3-6 weeks	11.00 kg	5.968	7.460
Fabric gr. 5	Karakorum, Sisu	Black, Bronzed, Polished Aluminium	3-6 weeks	11.00 kg	6.928	8.660
Fabric gr. 6	Fuse, Gentle	Black, Bronzed, Polished Aluminium	3-6 weeks	11.00 kg	7.648	9.560
Leather	Tailor Semi-aniline leather	Black, Bronzed, Polished Aluminium	3-6 weeks	11.00 kg	6.452	8.065
Leather	Noble Aniline leather	Black, Bronzed, Polished Aluminium	3-6 weeks	11.00 kg	7.768	9.710
Leather	Elmosoft Semi-aniline leather	Black, Bronzed, Polished Aluminium	3-6 weeks	11.00 kg	8.364	10.455
Fabric COM	COM Fabric	Black, Bronzed, Polished Aluminium	3-6 weeks	11.00 kg	5.136	6.420

Price group	Seat Upholstery	Lead time	PRICE EX. VAT (SEK)	PRICE INC. VAT (SEK)
Fabric gr. 1	Hot Madison, Remix, Re-Wool	3-6 weeks 11.00 kg	1.196	1.495
Fabric gr. 2	Canvas, Barnum, Fiord, Ritz	3-6 weeks 11.00 kg	1.556	1.945
Fabric gr. 3	Clay, Hallingdal, Steelcut Quartet, Steelcut Trio	3-6 weeks 11.00 kg	1.676	2.095
Fabric gr. 4	Acca, Cifrado, Ecriture, Moss, Uniform Melange, Vidar	3-6 weeks 11.00 kg	2.032	2.540
Fabric gr. 5	Karakorum, Sisu	3-6 weeks 11.00 kg	2.512	3.140
Fabric gr. 6	Fuse, Gentle	3-6 weeks 11.00 kg	2.752	3.440
Leather	Tailor Semi-aniline leather	3-6 weeks 11.00 kg	1.912	2.390
Leather	Noble Aniline leather	3-6 weeks 11.00 kg	2.032	2.540
Leather	Elmosoft Semi-aniline leather	3-6 weeks 11.00 kg	2.512	3.140
Fabric COM	COM Fabric	3-6 weeks 11.00 kg	1.196	1.495

Material: Shell made from 100% recycled polypropylene with fiber glass, covered with HR foam with fabric or leather upholstery, aluminium swivel base.

Fabric usage: 1.5 meters (shell), 0.77 meters (cushion) based on 140cm roll.
Leather usage: 2.64 square meters (shell), 0.77 square meters (cushion) based on a yield of 60% pr hide.

Plastic gliders installed as standard.
Felt gliders available upon request.

COM must be approved by &Tradition to ensure suitability for upholstery.

Minimum order quantity of same variant: 4 pcs.

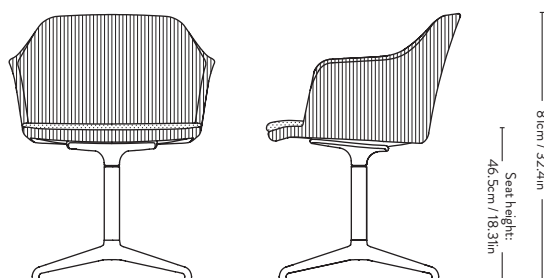

Rely ^{HW43} Hee Welling 2021



Item code	Shell Colour	Model	Base	Lead time	Weight	PRICE EX. VAT (SEK)	PRICE INC. VAT (SEK)
HW	Black	HW43	Black, Bronzed, Polished Aluminium	2-3 weeks	9.40 kg	3.816	4.770
HW	White	HW43	Black, Bronzed, Polished Aluminium	2-3 weeks	9.40 kg	3.816	4.770
HW	Beige Sand	HW43	Black, Bronzed, Polished Aluminium	2-3 weeks	9.40 kg	3.816	4.770
HW	Red Brown	HW43	Black, Bronzed, Polished Aluminium	2-3 weeks	9.40 kg	3.816	4.770
HW	Light Blue	HW43	Black, Bronzed, Polished Aluminium	2-3 weeks	9.40 kg	3.816	4.770
HW	Stone Grey	HW43	Black, Bronzed, Polished Aluminium	2-3 weeks	9.40 kg	3.816	4.770
HW	Vermilion red	HW43	Black, Bronzed, Polished Aluminium	2-3 weeks	9.40 kg	3.816	4.770
HW	Bronze green	HW43	Black, Bronzed, Polished Aluminium	2-3 weeks	9.40 kg	3.816	4.770
HW	Soft Pink	HW43	Black, Bronzed, Polished Aluminium	2-3 weeks	9.40 kg	3.816	4.770

Material: Shell made from 100% recycled polypropylene with fiber glass and an aluminium swivel base w. return function.

Plastic gliders installed as standard.
Felt gliders available upon request.

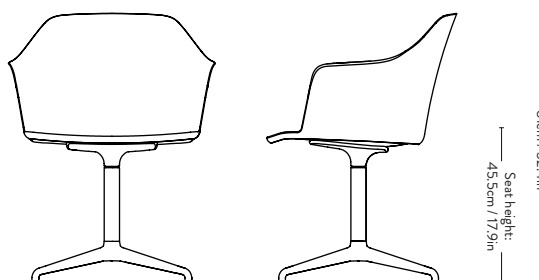

60.8cm / 23.9in

56.5cm / 22.6in

Armrest height

67.3cm / 26.5in

Rely^{HW44} Hee Welling 2021



Price group	Shell Colour	Seat Cushion Upholstery	Base	Lead time	Weight	PRICE EX. VAT (SEK)	PRICE INC. VAT (SEK)
Fabric gr. 1	Black, White, Beige Sand, Red Brown, Light Blue, Stone Grey, Vermilion red, Bronze green, Soft Pink	Hot Madison, Remix, Re-Wool	Black, Bronzed, Polished Aluminium	3-6 weeks	10.70 kg	5.488	6.860
Fabric gr. 2	Black, White, Beige Sand, Red Brown, Light Blue, Stone Grey, Vermilion red, Bronze green, Soft Pink	Canvas, Barnum, Fiord, Ritz	Black, Bronzed, Polished Aluminium	3-6 weeks	10.70 kg	5.844	7.305
Fabric gr. 3	Black, White, Beige Sand, Red Brown, Light Blue, Stone Grey, Vermilion red, Bronze green, Soft Pink	Clay, Hallingdal, Steelcut Quartet, Steelcut Trio	Black, Bronzed, Polished Aluminium	3-6 weeks	10.70 kg	5.964	7.455
Fabric gr. 4	Black, White, Beige Sand, Red Brown, Light Blue, Stone Grey, Vermilion red, Bronze green, Soft Pink	Acca, Cifrado, Ecriture, Moss, Uniform Melange, Vidar	Black, Bronzed, Polished Aluminium	3-6 weeks	10.70 kg	6.324	7.905
Fabric gr. 5	Black, White, Beige Sand, Red Brown, Light Blue, Stone Grey, Vermilion red, Bronze green, Soft Pink	Karakorum, Sisu	Black, Bronzed, Polished Aluminium	3-6 weeks	10.70 kg	6.800	8.500
Fabric gr. 6	Black, White, Beige Sand, Red Brown, Light Blue, Stone Grey, Vermilion red, Bronze green, Soft Pink	Fuse, Gentle	Black, Bronzed, Polished Aluminium	3-6 weeks	10.70 kg	7.516	9.395
Leather	Black, White, Beige Sand, Red Brown, Light Blue, Stone Grey, Vermilion red, Bronze green, Soft Pink	Tailor Semi-aniline leather	Black, Bronzed, Polished Aluminium	3-6 weeks	10.70 kg	5.964	7.455
Leather	Black, White, Beige Sand, Red Brown, Light Blue, Stone Grey, Vermilion red, Bronze green, Soft Pink	Noble Aniline leather	Black, Bronzed, Polished Aluminium	3-6 weeks	10.70 kg	6.324	7.905
Leather	Black, White, Beige Sand, Red Brown, Light Blue, Stone Grey, Vermilion red, Bronze green, Soft Pink	Elmosoft Semi-aniline leather	Black, Bronzed, Polished Aluminium	3-6 weeks	10.70 kg	6.680	8.350
Fabric COM	Black, White, Beige Sand, Red Brown, Light Blue, Stone Grey, Vermilion red, Bronze green, Soft Pink	COM Fabric	Black, Bronzed, Polished Aluminium	3-6 weeks	10.70 kg	5.488	6.860

Material: Shell made from 100% recycled polypropylene with fiber glass, HR foam seat covered with fabric or leather upholstery, aluminium swivel base w. return function.

Fabric usage: 0.49 meter based on a 140 cm roll.

Leather usage: 1 square meter based on a yield of 60% pr hide.

COM must be approved by &Tradition to ensure suitability for upholstery.

Plastic gliders installed as standard.

Felt gliders available upon request.

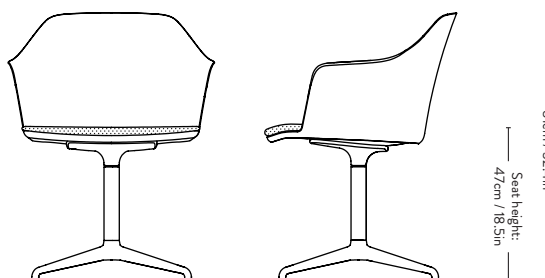

Rely^{HW45} Hee Welling 2021



Price group	Upholstery	Model	Base	Lead time	Weight	PRICE EX. VAT (SEK)	PRICE INC. VAT (SEK)
Fabric gr. 1	Hot Madison, Remix, Re-Wool	HW45	Black, Bronzed, Polished Aluminium	3-6 weeks	9.90 kg	6.440	8.050
Fabric gr. 2	Canvas, Barnum, Fiord, Ritz	HW45	Black, Bronzed, Polished Aluminium	3-6 weeks	9.90 kg	7.160	8.950
Fabric gr. 3	Clay, Hallingdal, Steelcut Quartet, Steelcut Trio	HW45	Black, Bronzed, Polished Aluminium	3-6 weeks	9.90 kg	7.396	9.245
Fabric gr. 4	Acca, Cifrado, Ecriture, Moss, Uniform Melange, Vidar	HW45	Black, Bronzed, Polished Aluminium	3-6 weeks	9.90 kg	8.112	10.140
Fabric gr. 5	Karakorum, Sisu	HW45	Black, Bronzed, Polished Aluminium	3-6 weeks	9.90 kg	9.548	11.935
Fabric gr. 6	Fuse, Gentle	HW45	Black, Bronzed, Polished Aluminium	3-6 weeks	9.90 kg	10.500	13.125
Leather	Tailor Semi-aniline leather	HW45	Black, Bronzed, Polished Aluminium	3-6 weeks	9.90 kg	8.472	10.590
Leather	Noble Aniline leather	HW45	Black, Bronzed, Polished Aluminium	3-6 weeks	9.90 kg	9.904	12.380
Leather	Elmosoft Semi-aniline leather	HW45	Black, Bronzed, Polished Aluminium	3-6 weeks	9.90 kg	10.740	13.425
Fabric COM	COM Fabric	HW45	Black, Bronzed, Polished Aluminium	3-6 weeks	9.90 kg	6.440	8.050

Material: Shell made from 100% recycled polypropylene with fiber glass, covered with HR foam with fabric or leather upholstery, aluminium swivel base with return.

Fabric usage: 1.5 meters based on 140cm roll.

Leather usage: 2.7 square meters based on a yield of 60% pr hide.

Plastic gliders installed as standard.

Felt gliders available upon request.

COM must be approved by &Tradition to ensure suitability for upholstery.

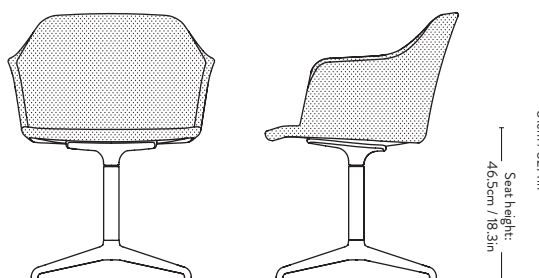

Rely^{HW46} Hee Welling 2021



Price group	Upholstery	Model	Base	Lead time	Weight	PRICE EX. VAT (SEK)	PRICE INC. VAT (SEK)
Fabric gr. 1	Hot Madison, Remix, Re-Wool	HW46	Black, Bronzed, Polished Aluminium	3-6 weeks	11.00 kg	6.800	8.500
Fabric gr. 2	Canvas, Barnum, Fiord, Ritz	HW46	Black, Bronzed, Polished Aluminium	3-6 weeks	11.00 kg	7.516	9.395
Fabric gr. 3	Clay, Hallingdal, Steelcut Quartet, Steelcut Trio	HW46	Black, Bronzed, Polished Aluminium	3-6 weeks	11.00 kg	7.756	9.695
Fabric gr. 4	Acca, Cifrado, Ecriture, Moss, Uniform Melange, Vidar	HW46	Black, Bronzed, Polished Aluminium	3-6 weeks	11.00 kg	8.472	10.590
Fabric gr. 5	Karakorum, Sisu	HW46	Black, Bronzed, Polished Aluminium	3-6 weeks	11.00 kg	9.904	12.380
Fabric gr. 6	Fuse, Gentle	HW46	Black, Bronzed, Polished Aluminium	3-6 weeks	11.00 kg	10.860	13.575
Leather	Tailor Semi-aniline leather	HW46	Black, Bronzed, Polished Aluminium	3-6 weeks	11.00 kg	8.828	11.035
Leather	Noble Aniline leather	HW46	Black, Bronzed, Polished Aluminium	3-6 weeks	11.00 kg	10.264	12.830
Leather	Elmosoft Semi-aniline leather	HW46	Black, Bronzed, Polished Aluminium	3-6 weeks	11.00 kg	11.336	14.170
Fabric COM	COM Fabric	HW46	Black, Bronzed, Polished Aluminium	3-6 weeks	11.00 kg	6.800	8.500

Material: Shell made from 100% recycled polypropylene with fiber glass, covered with HR foam with fabric or leather upholstery, aluminium swivel base with return.

Fabric usage: 2.3 meters based on 140cm roll.

Leather usage: 3.4 square meters based on a yield of 60% pr hide.

Plastic gliders installed as standard.

Felt gliders available upon request.

COM must be approved by &Tradition to ensure suitability for upholstery.

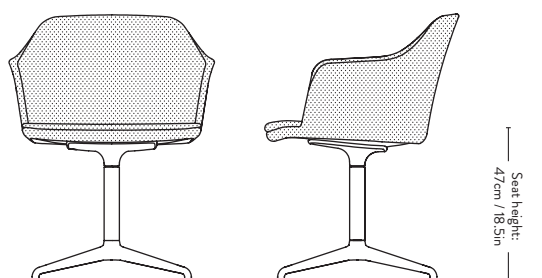

Rely ^{HW47} Hee Welling 2021



Please note that price is accumulated price of shell & seat.

Price group	Shell Upholstery	Base	Lead time	Weight	PRICE EX. VAT (SEK)	PRICE INC. VAT (SEK)
Fabric gr. 1	Hot Madison, Remix, Re-Wool	Black, Bronzed, Polished Aluminium	3-6 weeks	11.00 kg	5.616	7.020
Fabric gr. 2	Canvas, Barnum, Fiord, Ritz	Black, Bronzed, Polished Aluminium	3-6 weeks	11.00 kg	5.972	7.465
Fabric gr. 3	Clay, Hallingdal, Steelcut Quartet, Steelcut Trio	Black, Bronzed, Polished Aluminium	3-6 weeks	11.00 kg	6.092	7.615
Fabric gr. 4	Acca, Cifrado, Ecriture, Moss, Uniform Melange, Vidar	Black, Bronzed, Polished Aluminium	3-6 weeks	11.00 kg	6.444	8.055
Fabric gr. 5	Karakorum, Sisu	Black, Bronzed, Polished Aluminium	3-6 weeks	11.00 kg	7.408	9.260
Fabric gr. 6	Fuse, Gentle	Black, Bronzed, Polished Aluminium	3-6 weeks	11.00 kg	8.124	10.155
Leather	Tailor Semi-aniline leather	Black, Bronzed, Polished Aluminium	3-6 weeks	11.00 kg	6.916	8.645
Leather	Noble Aniline leather	Black, Bronzed, Polished Aluminium	3-6 weeks	11.00 kg	8.236	10.295
Leather	Elmosoft Semi-aniline leather	Black, Bronzed, Polished Aluminium	3-6 weeks	11.00 kg	8.844	11.055
Fabric COM	COM Fabric	Black, Bronzed, Polished Aluminium	3-6 weeks	11.00 kg	5.616	7.020

Price group	Seat Upholstery	Lead time	PRICE EX. VAT (SEK)	PRICE INC. VAT (SEK)
Fabric gr. 1	Hot Madison, Remix, Re-Wool	3-6 weeks	1.196	1.495
Fabric gr. 2	Canvas, Barnum, Fiord, Ritz	3-6 weeks	1.556	1.945
Fabric gr. 3	Clay, Hallingdal, Steelcut Quartet, Steelcut Trio	3-6 weeks	1.676	2.095
Fabric gr. 4	Acca, Cifrado, Ecriture, Moss, Uniform Melange, Vidar	3-6 weeks	2.032	2.540
Fabric gr. 5	Karakorum, Sisu	3-6 weeks	2.512	3.140
Fabric gr. 6	Fuse, Gentle	3-6 weeks	2.752	3.440
Leather	Tailor Semi-aniline leather	3-6 weeks	1.912	2.390
Leather	Noble Aniline leather	3-6 weeks	2.032	2.540
Leather	Elmosoft Semi-aniline leather	3-6 weeks	2.512	3.140
Fabric COM	COM Fabric	3-6 weeks	1.196	1.495

Material: Shell made from 100% recycled polypropylene with fiber glass, covered with HR foam with fabric or leather upholstery, aluminium swivel base with return.

Fabric usage: 1.5 meters (shell), 0.77 meters (cushion) based on 140cm roll.
Leather usage: 2.64 square meters (shell), 0.77 square meters (cushion) based on a yield of 60% pr hide.

Plastic gliders installed as standard.
Felt gliders available upon request.

COM must be approved by &Tradition to ensure suitability for upholstery.

Minimum order quantity of same variant: 4 pcs.

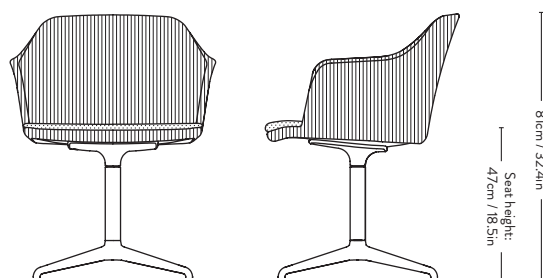

Rely ^{HW48} Hee Welling 2021



Item code	Shell Colour	Model	Base	Lead time	Weight	PRICE EX. VAT (SEK)	PRICE INC. VAT (SEK)
HW	Black	HW48	Black, Bronzed, Polished Aluminium	2-3 weeks	9.40 kg	3.816	4.770
HW	White	HW48	Black, Bronzed, Polished Aluminium	2-3 weeks	9.40 kg	3.816	4.770
HW	Beige Sand	HW48	Black, Bronzed, Polished Aluminium	2-3 weeks	9.40 kg	3.816	4.770
HW	Red Brown	HW48	Black, Bronzed, Polished Aluminium	2-3 weeks	9.40 kg	3.816	4.770
HW	Light Blue	HW48	Black, Bronzed, Polished Aluminium	2-3 weeks	9.40 kg	3.816	4.770
HW	Stone Grey	HW48	Black, Bronzed, Polished Aluminium	2-3 weeks	9.40 kg	3.816	4.770
HW	Vermilion red	HW48	Black, Bronzed, Polished Aluminium	2-3 weeks	9.40 kg	3.816	4.770
HW	Bronze green	HW48	Black, Bronzed, Polished Aluminium	2-3 weeks	9.40 kg	3.816	4.770
HW	Soft Pink	HW48	Black, Bronzed, Polished Aluminium	2-3 weeks	9.40 kg	3.816	4.770

Material: Shell made from 100% recycled polypropylene with fiber glass, aluminium swivel base with castors.

Castors suitable for all floor types.

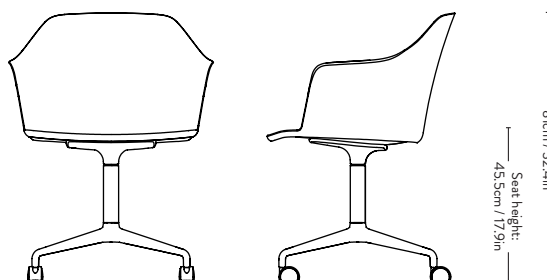

Rely^{HW49} Hee Welling 2021



Price group	Shell Colour	Seat Cushion Upholstery	Base	Lead time	Weight	PRICE EX. VAT (SEK)	PRICE INC. VAT (SEK)
Fabric gr. 1	Black, White, Beige Sand, Red Brown, Light Blue, Stone Grey, Vermilion red, Bronze green, Soft Pink	Hot Madison, Remix, Re-Wool	Black, Bronzed, Polished Aluminium	3-6 weeks	10.70 kg	5.488	6.860
Fabric gr. 2	Black, White, Beige Sand, Red Brown, Light Blue, Stone Grey, Vermilion red, Bronze green, Soft Pink	Canvas, Barnum, Fiord, Ritz	Black, Bronzed, Polished Aluminium	3-6 weeks	10.70 kg	5.844	7.305
Fabric gr. 3	Black, White, Beige Sand, Red Brown, Light Blue, Stone Grey, Vermilion red, Bronze green, Soft Pink	Clay, Hallingdal, Steelcut Quartet, Steelcut Trio	Black, Bronzed, Polished Aluminium	3-6 weeks	10.70 kg	5.964	7.455
Fabric gr. 4	Black, White, Beige Sand, Red Brown, Light Blue, Stone Grey, Vermilion red, Bronze green, Soft Pink	Acca, Cifrado, Ecriture, Moss, Uniform Melange, Vidar	Black, Bronzed, Polished Aluminium	3-6 weeks	10.70 kg	6.324	7.905
Fabric gr. 5	Black, White, Beige Sand, Red Brown, Light Blue, Stone Grey, Vermilion red, Bronze green, Soft Pink	Karakorum, Sisu	Black, Bronzed, Polished Aluminium	3-6 weeks	10.70 kg	6.800	8.500
Fabric gr. 6	Black, White, Beige Sand, Red Brown, Light Blue, Stone Grey, Vermilion red, Bronze green, Soft Pink	Fuse, Gentle	Black, Bronzed, Polished Aluminium	3-6 weeks	10.70 kg	7.396	9.245
Leather	Black, White, Beige Sand, Red Brown, Light Blue, Stone Grey, Vermilion red, Bronze green, Soft Pink	Tailor Semi-aniline leather	Black, Bronzed, Polished Aluminium	3-6 weeks	10.70 kg	5.964	7.455
Leather	Black, White, Beige Sand, Red Brown, Light Blue, Stone Grey, Vermilion red, Bronze green, Soft Pink	Noble Aniline leather	Black, Bronzed, Polished Aluminium	3-6 weeks	10.70 kg	6.324	7.905
Leather	Black, White, Beige Sand, Red Brown, Light Blue, Stone Grey, Vermilion red, Bronze green, Soft Pink	Elmosoft Semi-aniline leather	Black, Bronzed, Polished Aluminium	3-6 weeks	10.70 kg	6.680	8.350
Fabric COM	Black, White, Beige Sand, Red Brown, Light Blue, Stone Grey, Vermilion red, Bronze green, Soft Pink	COM Fabric	Black, Bronzed, Polished Aluminium	3-6 weeks	10.70 kg	5.488	6.860

Material: Shell made from 100% recycled polypropylene with fiber glass, HR foam seat covered with fabric or leather upholstery, aluminium swivel base and castors.

Fabric usage: 0.49 meter based on a 140 cm roll.

Leather usage: 1 square meter based on a yield of 60% pr hide.

Castors suitable for all floor types.

COM must be approved by &Tradition to ensure suitability for upholstery.

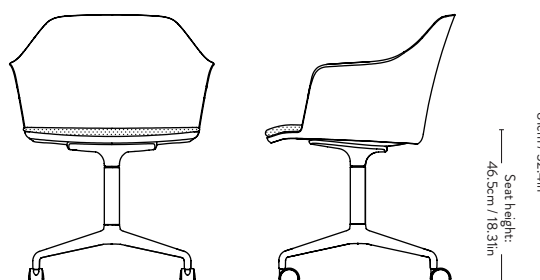

61cm / 24.4in 58.5cm / 23.0in Armrest height: 67.3cm / 26.7in

22% RABATT SKA DRAS AV PÅ ANGIVNA PRISER

Rely^{HW50} Hee Welling 2021



Price group	Upholstery	Model	Base	Lead time	Weight	PRICE EX. VAT (SEK)	PRICE INC. VAT (SEK)
Fabric gr. 1	Hot Madison, Remix, Re-Wool	HW50	Black, Bronzed, Polished Aluminium	3-6 weeks	9.90 kg	6.440	8.050
Fabric gr. 2	Canvas, Barnum, Fiord, Ritz	HW50	Black, Bronzed, Polished Aluminium	3-6 weeks	9.90 kg	7.160	8.950
Fabric gr. 3	Clay, Hallingdal, Steelcut Quartet, Steelcut Trio	HW50	Black, Bronzed, Polished Aluminium	3-6 weeks	9.90 kg	7.396	9.245
Fabric gr. 4	Acca, Cifrado, Ecriture, Moss, Uniform Melange, Vidar	HW50	Black, Bronzed, Polished Aluminium	3-6 weeks	9.90 kg	8.112	10.140
Fabric gr. 5	Karakorum, Sisu	HW50	Black, Bronzed, Polished Aluminium	3-6 weeks	9.90 kg	9.548	11.935
Fabric gr. 6	Fuse, Gentle	HW50	Black, Bronzed, Polished Aluminium	3-6 weeks	9.90 kg	10.500	13.125
Leather	Tailor Semi-aniline leather	HW50	Black, Bronzed, Polished Aluminium	3-6 weeks	9.90 kg	8.472	10.590
Leather	Noble Aniline leather	HW50	Black, Bronzed, Polished Aluminium	3-6 weeks	9.90 kg	9.904	12.380
Leather	Elmosoft Semi-aniline leather	HW50	Black, Bronzed, Polished Aluminium	3-6 weeks	9.90 kg	10.740	13.425
Fabric COM	COM Fabric	HW50	Black, Bronzed, Polished Aluminium	3-6 weeks	9.90 kg	6.440	8.050

Material: Shell made from 100% recycled polypropylene with fiber glass, covered with HR foam with fabric or leather upholstery, aluminium swivel base with castors.

Fabric usage: 1.5 meters based on 140cm roll.

Leather usage: 2.7 square meters based on a yield of 60% pr hide.

Castors suitable for all floor types.

COM must be approved by &Tradition to ensure suitability for upholstery.

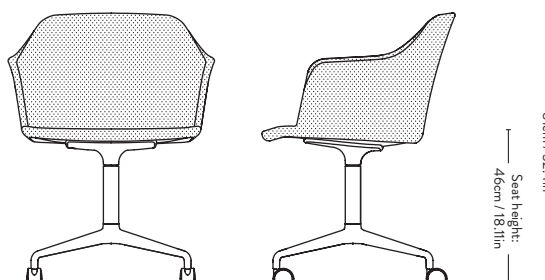

Rely^{HW51} Hee Welling 2021



Price group	Upholstery	Model	Base	Lead time	Weight	PRICE EX. VAT (SEK)	PRICE INC. VAT (SEK)
Fabric gr. 1	Hot Madison, Remix, Re-Wool	HW51	Black, Bronzed, Polished Aluminium	3-6 weeks	11.00 kg	6.800	8.500
Fabric gr. 2	Canvas, Barnum, Fiord, Ritz	HW51	Black, Bronzed, Polished Aluminium	3-6 weeks	11.00 kg	7.516	9.395
Fabric gr. 3	Clay, Hallingdal, Steelcut Quartet, Steelcut Trio	HW51	Black, Bronzed, Polished Aluminium	3-6 weeks	11.00 kg	7.636	9.545
Fabric gr. 4	Acca, Cifrado, Ecriture, Moss, Uniform Melange, Vidar	HW51	Black, Bronzed, Polished Aluminium	3-6 weeks	11.00 kg	8.472	10.590
Fabric gr. 5	Karakorum, Sisu	HW51	Black, Bronzed, Polished Aluminium	3-6 weeks	11.00 kg	9.904	12.380
Fabric gr. 6	Fuse, Gentle	HW51	Black, Bronzed, Polished Aluminium	3-6 weeks	11.00 kg	10.860	13.575
Leather	Tailor Semi-aniline leather	HW51	Black, Bronzed, Polished Aluminium	3-6 weeks	11.00 kg	8.828	11.035
Leather	Noble Aniline leather	HW51	Black, Bronzed, Polished Aluminium	3-6 weeks	11.00 kg	10.264	12.830
Leather	Elmosoft Semi-aniline leather	HW51	Black, Bronzed, Polished Aluminium	3-6 weeks	11.00 kg	11.336	14.170
Fabric COM	COM Fabric	HW51	Black, Bronzed, Polished Aluminium	3-6 weeks	11.00 kg	6.800	8.500

Material: Shell made from 100% recycled polypropylene with fiber glass, covered with HR foam with fabric or leather upholstery, aluminium swivel base with castors.

Fabric usage: 2.3 meters based on 140cm roll.

Leather usage: 3.4 square meters based on a yield of 60% pr hide.

Castors suitable for all floor types.

COM must be approved by &Tradition to ensure suitability for upholstery.

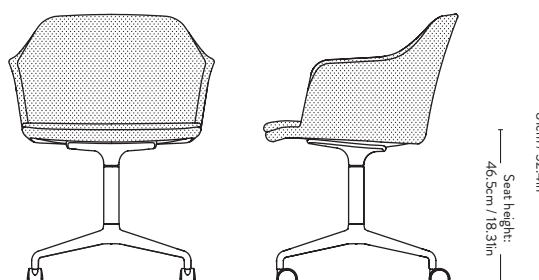

61cm / 24.0in 58.5cm / 22.0in Armrest height: 47.3cm / 18.6in

22% RABATT SKA DRAS AV PÅ ANGIVNA PRISER

Rely ^{HW52} Hee Welling 2021



Please note that price is accumulated price of shell & seat.

Price group	Shell Upholstery	Base	Lead time	Weight	PRICE EX. VAT (SEK)	PRICE INC. VAT (SEK)
Fabric gr. 1	Hot Madison, Remix, Re-Wool	Black, Bronzed, Polished Aluminium	3-6 weeks	11.00 kg	5.616	7.020
Fabric gr. 2	Canvas, Barnum, Fiord, Ritz	Black, Bronzed, Polished Aluminium	3-6 weeks	11.00 kg	5.972	7.465
Fabric gr. 3	Clay, Hallingdal, Steelcut Quartet, Steelcut Trio	Black, Bronzed, Polished Aluminium	3-6 weeks	11.00 kg	5.972	7.465
Fabric gr. 4	Acca, Cifrado, Ecriture, Moss, Uniform Melange, Vidar	Black, Bronzed, Polished Aluminium	3-6 weeks	11.00 kg	6.444	8.055
Fabric gr. 5	Karakorum, Sisu	Black, Bronzed, Polished Aluminium	3-6 weeks	11.00 kg	7.408	9.260
Fabric gr. 6	Fuse, Gentle	Black, Bronzed, Polished Aluminium	3-6 weeks	11.00 kg	8.124	10.155
Leather	Tailor Semi-aniline leather	Black, Bronzed, Polished Aluminium	3-6 weeks	11.00 kg	6.916	8.645
Leather	Noble Aniline leather	Black, Bronzed, Polished Aluminium	3-6 weeks	11.00 kg	8.236	10.295
Leather	Elmosoft Semi-aniline leather	Black, Bronzed, Polished Aluminium	3-6 weeks	11.00 kg	8.844	11.055
Fabric COM	COM Fabric	Black, Bronzed, Polished Aluminium	3-6 weeks	11.00 kg	5.616	7.020

Price group	Seat Upholstery	Lead time	PRICE EX. VAT (SEK)	PRICE INC. VAT (SEK)
Fabric gr. 1	Hot Madison, Remix, Re-Wool	3-6 weeks	1.196	1.495
Fabric gr. 2	Canvas, Barnum, Fiord, Ritz	3-6 weeks	1.556	1.945
Fabric gr. 3	Clay, Hallingdal, Steelcut Quartet, Steelcut Trio	3-6 weeks	1.676	2.095
Fabric gr. 4	Acca, Cifrado, Ecriture, Moss, Uniform Melange, Vidar	3-6 weeks	2.032	2.540
Fabric gr. 5	Karakorum, Sisu	3-6 weeks	2.512	3.140
Fabric gr. 6	Fuse, Gentle	3-6 weeks	2.752	3.440
Leather	Tailor Semi-aniline leather	3-6 weeks	1.912	2.390
Leather	Noble Aniline leather	3-6 weeks	2.032	2.540
Leather	Elmosoft Semi-aniline leather	3-6 weeks	2.512	3.140
Fabric COM	COM Fabric	3-6 weeks	1.196	1.495

Material: Shell made from 100% recycled polypropylene with fiber glass, covered with HR foam with fabric or leather upholstery, aluminium swivel base with castors.

Fabric usage: 1.5 meters (shell), 0.77 meters (cushion) based on 140cm roll.

Leather usage: 2.64 square meters (shell), 0.77 square meters (cushion) based on a yield of 60% pr hide.

COM must be approved by &Tradition to ensure suitability for upholstery.

Castors suitable for all floor types.

Minimum order quantity of same variant: 4 pcs.

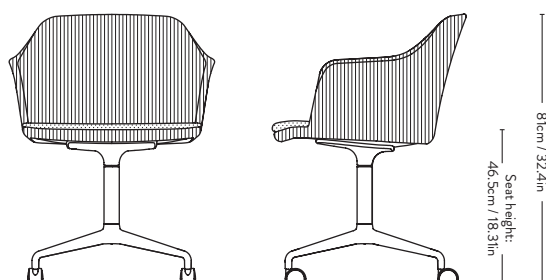

Rely ^{HW53} Hee Welling 2021



Item code	Shell Colour	Model	Base	Lead time	Weight	PRICE EX. VAT (SEK)	PRICE INC. VAT (SEK)
HW	Black	HW53	Black, Polished Aluminium	2-3 weeks	10.50 kg	4.532	5.665
HW	White	HW53	Black, Polished Aluminium	2-3 weeks	10.50 kg	4.532	5.665
HW	Beige Sand	HW53	Black, Polished Aluminium	2-3 weeks	10.50 kg	4.532	5.665
HW	Red Brown	HW53	Black, Polished Aluminium	2-3 weeks	10.50 kg	4.532	5.665
HW	Light Blue	HW53	Black, Polished Aluminium	2-3 weeks	10.50 kg	4.532	5.665
HW	Stone Grey	HW53	Black, Polished Aluminium	2-3 weeks	10.50 kg	4.532	5.665
HW	Vermilion red	HW53	Black, Polished Aluminium	2-3 weeks	10.50 kg	4.532	5.665
HW	Bronze green	HW53	Black, Polished Aluminium	2-3 weeks	10.50 kg	4.532	5.665
HW	Soft Pink	HW53	Black, Polished Aluminium	2-3 weeks	10.50 kg	4.532	5.665

Material: Shell made from 100% recycled polypropylene with fiber glass, cast aluminium 5-star swivel base w. gaslift & castors.

Castors suitable for all floor types.



EU Ecolabel certified, validating high standards of durability, circular design, and responsible use of chemicals. Please contact our sales team for a list of EU Ecolabel compliant combinations.

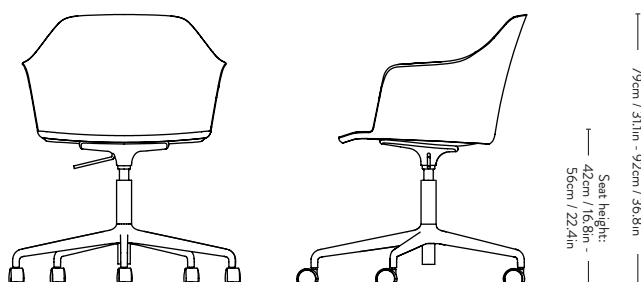

Rely ^{HW54} Hee Welling 2021



Price group	Shell Colour	Seat Cushion Upholstery	Base	Lead time	Weight	PRICE EX. VAT (SEK)	PRICE INC. VAT (SEK)
Fabric gr. 1	Black, White, Beige Sand, Red Brown, Light Blue, Stone Grey, Vermilion red, Bronze green, Soft Pink	Hot Madison, Remix, Re-Wool	Black, Polished Aluminium	3-6 weeks	11.80 kg	5.724	7.155
Fabric gr. 2	Black, White, Beige Sand, Red Brown, Light Blue, Stone Grey, Vermilion red, Bronze green, Soft Pink	Canvas, Barnum, Fiord, Ritz	Black, Polished Aluminium	3-6 weeks	11.80 kg	6.084	7.605
Fabric gr. 3	Black, White, Beige Sand, Red Brown, Light Blue, Stone Grey, Vermilion red, Bronze green, Soft Pink	Clay, Hallingdal, Steelcut Quartet, Steelcut Trio	Black, Polished Aluminium	3-6 weeks	11.80 kg	6.204	7.755
Fabric gr. 4	Black, White, Beige Sand, Red Brown, Light Blue, Stone Grey, Vermilion red, Bronze green, Soft Pink	Acca, Cifrado, Ecriture, Moss, Uniform Melange, Vidar	Black, Polished Aluminium	3-6 weeks	11.80 kg	6.560	8.200
Fabric gr. 5	Black, White, Beige Sand, Red Brown, Light Blue, Stone Grey, Vermilion red, Bronze green, Soft Pink	Karakorum, Sisu	Black, Polished Aluminium	3-6 weeks	11.80 kg	7.040	8.800
Fabric gr. 6	Black, White, Beige Sand, Red Brown, Light Blue, Stone Grey, Vermilion red, Bronze green, Soft Pink	Fuse, Gentle	Black, Polished Aluminium	3-6 weeks	11.80 kg	7.756	9.695
Leather	Black, White, Beige Sand, Red Brown, Light Blue, Stone Grey, Vermilion red, Bronze green, Soft Pink	Tailor Semi-aniline leather	Black, Polished Aluminium	3-6 weeks	11.80 kg	6.204	7.755
Leather	Black, White, Beige Sand, Red Brown, Light Blue, Stone Grey, Vermilion red, Bronze green, Soft Pink	Noble Aniline leather	Black, Polished Aluminium	3-6 weeks	11.80 kg	6.560	8.200
Leather	Black, White, Beige Sand, Red Brown, Light Blue, Stone Grey, Vermilion red, Bronze green, Soft Pink	Elmosoft Semi-aniline leather	Black, Polished Aluminium	3-6 weeks	11.80 kg	7.160	8.950
Fabric COM	Black, White, Beige Sand, Red Brown, Light Blue, Stone Grey, Vermilion red, Bronze green, Soft Pink	COM Fabric	Black, Polished Aluminium	3-6 weeks	11.80 kg	5.724	7.155



EU Ecolabel certified, validating high standards of durability, circular design, and responsible use of chemicals. Please contact our sales team for a list of EU Ecolabel compliant combinations.

Material: Shell made from 100% recycled polypropylene with fiber glass, seat covered in HR foam with fabric or leather upholstery, cast aluminium 5-star swivel base w. gaslift & castors.

Fabric usage: 0.49 meter based on a 140 cm roll.

Leather usage: 1 square meter based on a yield of 60% pr hide.

COM must be approved by &Tradition to ensure suitability for upholstery.

Castors suitable for all floor types.

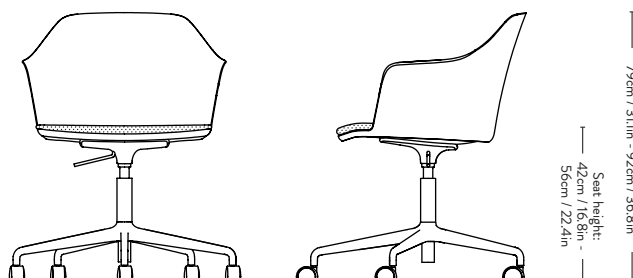

Rely^{HW55} Hee Welling 2021



Price group	Upholstery	Model	Base	Lead time	Weight	PRICE EX. VAT (SEK)	PRICE INC. VAT (SEK)
Fabric gr. 1	Hot Madison, Remix, Re-Wool	HW55	Black, Polished Aluminium	3-6 weeks	11.00 kg	6.920	8.650
Fabric gr. 2	Canvas, Barnum, Fiord, Ritz	HW55	Black, Polished Aluminium	3-6 weeks	11.00 kg	7.636	9.545
Fabric gr. 3	Clay, Hallingdal, Steelcut Quartet, Steelcut Trio	HW55	Black, Polished Aluminium	3-6 weeks	11.00 kg	7.876	9.845
Fabric gr. 4	Acca, Cifrado, Ecriture, Moss, Uniform Melange, Vidar	HW55	Black, Polished Aluminium	3-6 weeks	11.00 kg	8.592	10.740
Fabric gr. 5	Karakorum, Sisu	HW55	Black, Polished Aluminium	3-6 weeks	11.00 kg	10.144	12.680
Fabric gr. 6	Fuse, Gentle	HW55	Black, Polished Aluminium	3-6 weeks	11.00 kg	10.980	13.725
Leather	Tailor Semi-aniline leather	HW55	Black, Polished Aluminium	3-6 weeks	11.00 kg	8.948	11.185
Leather	Noble Aniline leather	HW55	Black, Polished Aluminium	3-6 weeks	11.00 kg	10.384	12.980
Leather	Elmosoft Semi-aniline leather	HW55	Black, Polished Aluminium	3-6 weeks	11.00 kg	11.216	14.020
Fabric COM	COM Fabric	HW55	Black, Polished Aluminium	3-6 weeks	11.00 kg	6.920	8.650

Material: Shell made from 100% recycled polypropylene with fiber glass, covered with HR foam with fabric or leather upholstery, cast aluminium 5-star swivel base w. gaslift & castors.

Castors suitable for all floor types.

Fabric usage: 1.5 meters based on 140cm roll.

Leather usage: 2.7 square meters based on a yield of 60% pr hide.

COM must be approved by &Tradition to ensure suitability for upholstery.



EU Ecolabel certified, validating high standards of durability, circular design, and responsible use of chemicals. Please contact our sales team for a list of EU Ecolabel compliant combinations.

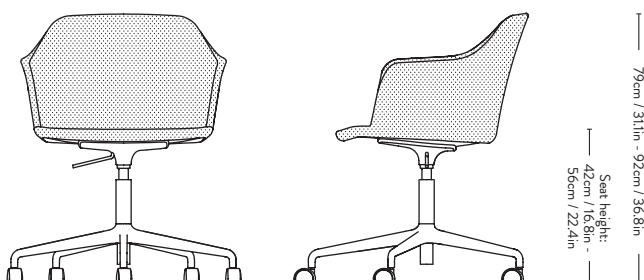

Rely ^{HW56} Hee Welling 2021



Price group	Upholstery	Model	Base	Lead time	Weight	PRICE EX. VAT (SEK)	PRICE INC. VAT (SEK)
Fabric gr. 1	Hot Madison, Remix, Re-Wool	HW56	Black, Polished Aluminium	3-6 weeks	12.10 kg	7.276	9.095
Fabric gr. 2	Canvas, Barnum, Fiord, Ritz	HW56	Black, Polished Aluminium	3-6 weeks	12.10 kg	7.996	9.995
Fabric gr. 3	Clay, Hallingdal, Steelcut Quartet, Steelcut Trio	HW56	Black, Polished Aluminium	3-6 weeks	12.10 kg	8.232	10.290
Fabric gr. 4	Acca, Cifrado, Ecriture, Moss, Uniform Melange, Vidar	HW56	Black, Polished Aluminium	3-6 weeks	12.10 kg	8.948	11.185
Fabric gr. 5	Karakorum, Sisu	HW56	Black, Polished Aluminium	3-6 weeks	12.10 kg	10.384	12.980
Fabric gr. 6	Fuse, Gentle	HW56	Black, Polished Aluminium	3-6 weeks	12.10 kg	11.456	14.320
Leather	Tailor Semi-aniline leather	HW56	Black, Polished Aluminium	3-6 weeks	12.10 kg	9.308	11.635
Leather	Noble Aniline leather	HW56	Black, Polished Aluminium	3-6 weeks	12.10 kg	10.740	13.425
Leather	Elmosoft Semi-aniline leather	HW56	Black, Polished Aluminium	3-6 weeks	12.10 kg	11.816	14.770
Fabric COM	COM Fabric	HW56	Black, Polished Aluminium	3-6 weeks	12.10 kg	7.276	9.095

Material: Shell made from 100% recycled polypropylene with fiber glass, covered with HR foam with fabric or leather upholstery, cast aluminium 5-star swivel base w. gaslift & castors.

Castors suitable for all floor types.

Fabric usage: 2.3 meters based on 140cm roll.

Leather usage: 3.4 square meters based on a yield of 60% pr hide.

COM must be approved by &Tradition to ensure suitability for upholstery.



EU Ecolabel certified, validating high standards of durability, circular design, and responsible use of chemicals. Please contact our sales team for a list of EU Ecolabel compliant combinations.

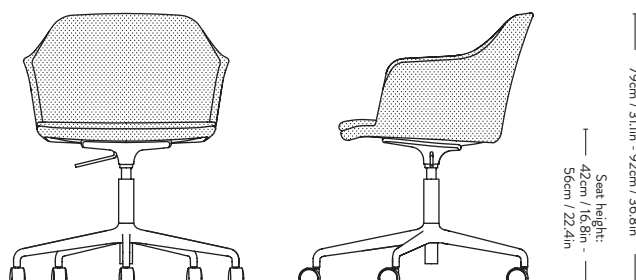

Rely ^{HW57} Hee Welling 2021



Please note that price is accumulated price of shell & seat.

Price group	Shell Upholstery	Base	Lead time	Weight	PRICE EX. VAT (SEK)	PRICE INC. VAT (SEK)
Fabric gr. 1	Hot Madison, Remix, Re-Wool	Black, Polished Aluminium	3-6 weeks	12.10 kg	6.080	7.600
Fabric gr. 2	Canvas, Barnum, Fiord, Ritz	Black, Polished Aluminium	3-6 weeks	12.10 kg	6.444	8.055
Fabric gr. 3	Clay, Hallingdal, Steelcut Quartet, Steelcut Trio	Black, Polished Aluminium	3-6 weeks	12.10 kg	6.572	8.215
Fabric gr. 4	Acca, Cifrado, Ecriture, Moss, Uniform Melange, Vidar	Black, Polished Aluminium	3-6 weeks	12.10 kg	6.928	8.660
Fabric gr. 5	Karakorum, Sisu	Black, Polished Aluminium	3-6 weeks	12.10 kg	7.888	9.860
Fabric gr. 6	Fuse, Gentle	Black, Polished Aluminium	3-6 weeks	12.10 kg	8.708	10.885
Leather	Tailor Semi-aniline leather	Black, Polished Aluminium	3-6 weeks	12.10 kg	7.408	9.260
Leather	Noble Aniline leather	Black, Polished Aluminium	3-6 weeks	12.10 kg	8.724	10.905
Leather	Elmosoft Semi-aniline leather	Black, Polished Aluminium	3-6 weeks	12.10 kg	9.320	11.650
Fabric COM	COM Fabric	Black, Polished Aluminium	3-6 weeks	12.10 kg	6.080	7.600

Price group	Seat Upholstery	Lead time	PRICE EX. VAT (SEK)	PRICE INC. VAT (SEK)
Fabric gr. 1	Hot Madison, Remix, Re-Wool	3-6 weeks	1.196	1.495
Fabric gr. 2	Canvas, Barnum, Fiord, Ritz	3-6 weeks	1.556	1.945
Fabric gr. 3	Clay, Hallingdal, Steelcut Quartet, Steelcut Trio	3-6 weeks	1.676	2.095
Fabric gr. 4	Acca, Cifrado, Ecriture, Moss, Uniform Melange, Vidar	3-6 weeks	2.032	2.540
Fabric gr. 5	Karakorum, Sisu	3-6 weeks	2.512	3.140
Fabric gr. 6	Fuse, Gentle	3-6 weeks	2.752	3.440
Leather	Tailor Semi-aniline leather	3-6 weeks	1.912	2.390
Leather	Noble Aniline leather	3-6 weeks	2.032	2.540
Leather	Elmosoft Semi-aniline leather	3-6 weeks	2.512	3.140
Fabric COM	COM Fabric	3-6 weeks	1.196	1.495

Material: Shell made from 100% recycled polypropylene with fiber glass, covered with HR foam with fabric or leather upholstery, cast aluminium 5-star swivel base w. gaslift & castors.

Castors suitable for all floor types.

Fabric usage: 1.5 meters (shell), 0.77 meters (cushion) based on 140cm roll.

Leather usage: 2.64 square meters (shell), 0.77 square meters (cushion) based on a yield of 60% pr hide.

COM must be approved by &Tradition to ensure suitability for upholstery.

Minimum order quantity of same variant: 4 pcs.



EU Ecolabel certified, validating high standards of durability, circular design, and responsible use of chemicals. Please contact our sales team for a list of EU Ecolabel compliant combinations.

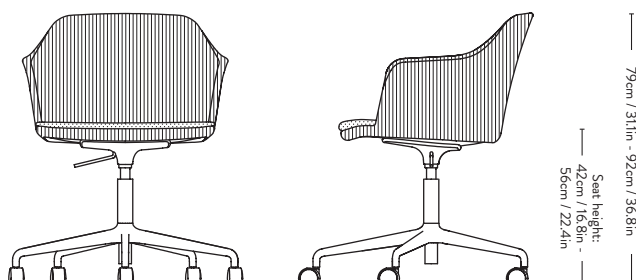

Rely^{HW71} Hee Welling 2022



Item code	Shell Colour	Model	Base	Colli qty.	Lead time	Weight	PRICE EX. VAT (SEK)	PRICE INC. VAT (SEK)
HW	Black	HW71	Oak Walnut	1 pc	2-3 weeks	5.70 kg	2.740 3.100	3.425 3.875
HW	White	HW71	Oak Walnut	1 pc	2-3 weeks	5.70 kg	2.740 3.100	3.425 3.875
HW	Beige Sand	HW71	Oak Walnut	1 pc	2-3 weeks	5.70 kg	2.740 3.100	3.425 3.875
HW	Red Brown	HW71	Oak Walnut	1 pc	2-3 weeks	5.70 kg	2.740 3.100	3.425 3.875
HW	Light Blue	HW71	Oak Walnut	1 pc	2-3 weeks	5.70 kg	2.740 3.100	3.425 3.875
HW	Stone Grey	HW71	Oak Walnut	1 pc	2-3 weeks	5.70 kg	2.740 3.100	3.425 3.875
HW	Vermilion red	HW71	Oak Walnut	1 pc	2-3 weeks	5.70 kg	2.740 3.100	3.425 3.875
HW	Bronze green	HW71	Oak Walnut	1 pc	2-3 weeks	5.70 kg	2.740 3.100	3.425 3.875
HW	Soft Pink	HW71	Oak Walnut	1 pc	2-3 weeks	5.70 kg	2.740 3.100	3.425 3.875

Material: Shell made from 100% recycled polypropylene with fiber glass. Water based lacquered oak or walnut base.

Wagner QuickClick Plast gliders are installed as standard.
Wagner QuickClick Felt gliders available upon request.



EU Ecolabel certified, validating high standards of durability, circular design, and responsible use of chemicals. Please contact our sales team for a list of EU Ecolabel compliant combinations.

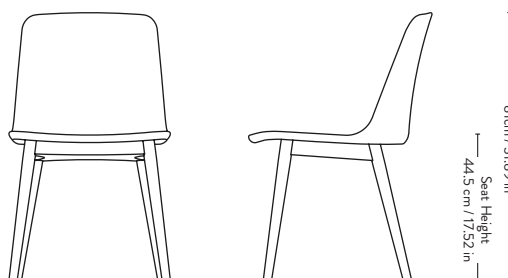

Rely^{HW72} Hee Welling 2022



Price group	Shell Colour	Seat Cushion Upholstery	Base	Lead time	Weight	PRICE EX. VAT (SEK)	PRICE INC. VAT (SEK)
Fabric gr. 1	Black, White, Beige Sand, Red Brown, Light Blue, Stone Grey, Vermilion red, Bronze green, Soft Pink	Hot Madison, Remix, Re-Wool	Oak	6-8 weeks	6.50 kg	4.172	5.215
			Walnut			4.532	5.665
Fabric gr. 2	Black, White, Beige Sand, Red Brown, Light Blue, Stone Grey, Vermilion red, Bronze green, Soft Pink	Canvas, Barnum, Fiord, Ritz	Oak	6-8 weeks	6.50 kg	4.532	5.665
			Walnut			4.888	6.110
Fabric gr. 3	Black, White, Beige Sand, Red Brown, Light Blue, Stone Grey, Vermilion red, Bronze green, Soft Pink	Clay, Hallingdal, Steelcut Quartet, Steelcut Trio	Oak	6-8 weeks	6.50 kg	4.652	5.815
			Walnut			5.128	6.410
Fabric gr. 4	Black, White, Beige Sand, Red Brown, Light Blue, Stone Grey, Vermilion red, Bronze green, Soft Pink	Acca, Cifrado, Ecriture, Moss, Uniform Melange, Vidar	Oak	6-8 weeks	6.50 kg	5.008	6.260
			Walnut			5.368	6.710
Fabric gr. 5	Black, White, Beige Sand, Red Brown, Light Blue, Stone Grey, Vermilion red, Bronze green, Soft Pink	Karakorum, Sisu	Oak	6-8 weeks	6.50 kg	5.488	6.860
			Walnut			5.844	7.305
Fabric gr. 6	Black, White, Beige Sand, Red Brown, Light Blue, Stone Grey, Vermilion red, Bronze green, Soft Pink	Fuse, Gentle	Oak	6-8 weeks	6.50 kg	6.084	7.605
			Walnut			6.440	8.050
Leather	Black, White, Beige Sand, Red Brown, Light Blue, Stone Grey, Vermilion red, Bronze green, Soft Pink	Tailor Semi-aniline leather	Oak	6-8 weeks	6.50 kg	4.652	5.815
			Walnut			5.008	6.260
Leather	Black, White, Beige Sand, Red Brown, Light Blue, Stone Grey, Vermilion red, Bronze green, Soft Pink	Noble Aniline leather	Oak	6-8 weeks	6.50 kg	5.008	6.260
			Walnut			5.368	6.710
Leather	Black, White, Beige Sand, Red Brown, Light Blue, Stone Grey, Vermilion red, Bronze green, Soft Pink	Elmosoft Semi-aniline leather	Oak	6-8 weeks	6.50 kg	5.368	6.710
			Walnut			5.724	7.155
Fabric COM	Black, White, Beige Sand, Red Brown, Light Blue, Stone Grey, Vermilion red, Bronze green, Soft Pink	COM Fabric	Oak	6-8 weeks	6.50 kg	4.172	5.215
			Walnut			4.532	5.665



EU Ecolabel certified, validating high standards of durability, circular design, and responsible use of chemicals. Please contact our sales team for a list of EU Ecolabel compliant combinations.

Material: Shell made from 100% recycled polypropylene with fiber glass. Upholstered seats are made with a veneer plate with 30mm HR foam. Water based lacquered oak or walnut base.

Wagner QuickClick Plast gliders are installed as standard.
Wagner QuickClick Felt gliders available upon request.

Fabric usage: 0.49 meter based on a 140 cm roll.

Leather usage: 1 square meter based on a yield of 60% pr hide.

COM must be approved by &Tradition to ensure suitability for upholstery.

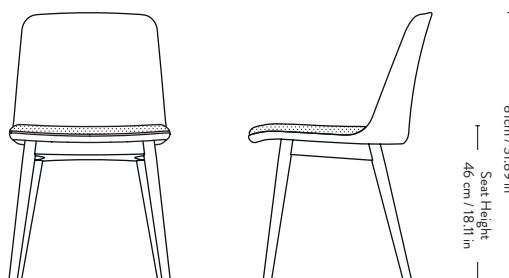

Rely ^{HW73} Hee Welling 2022



Price group	Upholstery	Model	Base	Lead time	Weight	PRICE EX. VAT (SEK)	PRICE INC. VAT (SEK)
Fabric gr. 1	Hot Madison, Remix, Re-Wool	HW73	Oak Walnut	6-8 weeks	6.20 kg	5.128 5.488	6.410 6.860
Fabric gr. 2	Canvas, Barnum, Fiord, Ritz	HW73	Oak Walnut	6-8 weeks	6.20 kg	5.844 6.204	7.305 7.755
Fabric gr. 3	Clay, Hallingdal, Steelcut Quartet, Steelcut Trio	HW73	Oak Walnut	6-8 weeks	6.20 kg	6.084 6.440	7.605 8.050
Fabric gr. 4	Acca, Cifrado, Ecriture, Moss, Uniform Melange, Vidar	HW73	Oak Walnut	6-8 weeks	6.20 kg	6.680 7.040	8.350 8.800
Fabric gr. 5	Karakorum, Sisu	HW73	Oak Walnut	6-8 weeks	6.20 kg	8.112 8.472	10.140 10.590
Fabric gr. 6	Fuse, Gentle	HW73	Oak Walnut	6-8 weeks	6.20 kg	8.948 9.308	11.185 11.635
Leather	Tailor Semi-aniline leather	HW73	Oak Walnut	6-8 weeks	6.20 kg	7.040 7.396	8.800 9.245
Leather	Noble Aniline leather	HW73	Oak Walnut	6-8 weeks	6.20 kg	7.396 7.756	9.245 9.695
Leather	Elmosoft Semi-aniline leather	HW73	Oak Walnut	6-8 weeks	6.20 kg	7.996 8.352	9.995 10.440
Fabric COM	COM Fabric	HW73	Oak Walnut	6-8 weeks	6.20 kg	5.128 5.488	6.410 6.860

Material: Shell made from 100% recycled polypropylene with fiber glass. Upholstered seats are made with a veneer plate with 30mm HR foam. Water based lacquered oak or walnut base.

Wagner QuickClick Plast gliders are installed as standard.
Wagner QuickClick Felt gliders available upon request.

Fabric usage: 1.4 meters based on 140cm roll.

Leather usage: 2.2 square meters based on a yield of 60% pr hide.

COM must be approved by &Tradition to ensure suitability for upholstery.



EU Ecolabel certified, validating high standards of durability, circular design, and responsible use of chemicals. Please contact our sales team for a list of EU Ecolabel compliant combinations.

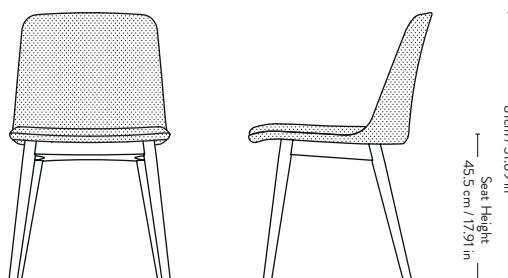

Rely ^{HW74} Hee Welling 2022



Price group	Upholstery	Model	Base	Lead time	Weight	PRICE EX. VAT (SEK)	PRICE INC. VAT (SEK)
Fabric gr. 1	Hot Madison, Remix, Re-Wool	HW74	Oak Walnut	6-8 weeks	7.30 kg	5.368 5.724	6.710 7.155
Fabric gr. 2	Canvas, Barnum, Fiord, Ritz	HW74	Oak Walnut	6-8 weeks	7.30 kg	6.084 6.440	7.605 8.050
Fabric gr. 3	Clay, Hallingdal, Steelcut Quartet, Steelcut Trio	HW74	Oak Walnut	6-8 weeks	7.30 kg	6.324 6.680	7.905 8.350
Fabric gr. 4	Acca, Cifrado, Ecriture, Moss, Uniform Melange, Vidar	HW74	Oak Walnut	6-8 weeks	7.30 kg	6.920 7.276	8.650 9.095
Fabric gr. 5	Karakorum, Sisu	HW74	Oak Walnut	6-8 weeks	7.30 kg	8.352 8.712	10.440 10.890
Fabric gr. 6	Fuse, Gentle	HW74	Oak Walnut	6-8 weeks	7.30 kg	9.188 9.548	11.485 11.935
Leather	Tailor Semi-aniline leather	HW74	Oak Walnut	6-8 weeks	7.30 kg	7.276 7.636	9.095 9.545
Leather	Noble Aniline leather	HW74	Oak Walnut	6-8 weeks	7.30 kg	7.636 7.996	9.545 9.995
Leather	Elmosoft Semi-aniline leather	HW74	Oak Walnut	6-8 weeks	7.30 kg	8.712 9.068	10.890 11.335
Fabric COM	COM Fabric	HW74	Oak Walnut	6-8 weeks	7.30 kg	5.368 5.724	6.710 7.155

Material: Shell made from 100% recycled polypropylene with fiber glass. Upholstered seats are made with a veneer plate with 30mm HR foam. Water based lacquered oak or walnut base.

Wagner QuickClick Plast gliders are installed as standard.
Wagner QuickClick Felt gliders available upon request.

Fabric usage: 1.8 meters based on 140cm roll.

Leather usage: 2.7 square meters based on a yield of 60% pr hide.

COM must be approved by &Tradition to ensure suitability for upholstery.



EU Ecolabel certified, validating high standards of durability, circular design, and responsible use of chemicals. Please contact our sales team for a list of EU Ecolabel compliant combinations.

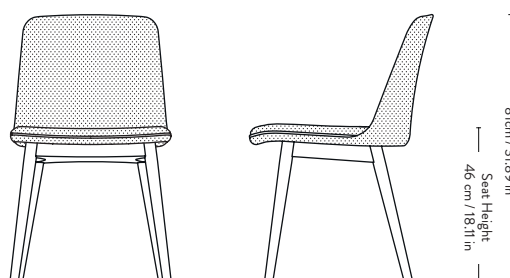

46.5 cm / 19.09 in 53.5 cm / 21.06 in Seating depth: 45 cm / 17.7 in

22% RABATT SKA DRAS AV PÅ ANGIVNA PRISER

Rely ^{HW75} Hee Welling 2022



Please note that price is accumulated price of shell & seat.

Price group	Shell Upholstery	Base	Lead time	Weight	PRICE EX. VAT (SEK)	PRICE INC. VAT (SEK)
Fabric gr. 1	Hot Madison, Remix, Re-Wool	Oak	3-6 weeks	7.30 kg	4.180	5.225
		Walnut			4.528	5.660
Fabric gr. 2	Canvas, Barnum, Fiord, Ritz	Oak	3-6 weeks	7.30 kg	4.540	5.675
		Walnut			4.896	6.120
Fabric gr. 3	Clay, Hallingdal, Steelcut Quartet, Steelcut Trio	Oak	3-6 weeks	7.30 kg	4.656	5.820
		Walnut			5.016	6.270
Fabric gr. 4	Acca, Cifrado, Ecriture, Moss, Uniform Melange, Vidar	Oak	3-6 weeks	7.30 kg	4.892	6.115
		Walnut			5.256	6.570
Fabric gr. 5	Karakorum, Sisu	Oak	3-6 weeks	7.30 kg	5.852	7.315
		Walnut			6.212	7.765
Fabric gr. 6	Fuse, Gentle	Oak	3-6 weeks	7.30 kg	6.452	8.065
		Walnut			6.812	8.515
Leather	Tailor Semi-aniline leather	Oak	3-6 weeks	7.30 kg	5.364	6.705
		Walnut			5.732	7.165
Leather	Noble Aniline leather	Oak	3-6 weeks	7.30 kg	5.608	7.010
		Walnut			5.968	7.460
Leather	Elmosoft Semi-aniline leather	Oak	3-6 weeks	7.30 kg	6.212	7.765
		Walnut			6.572	8.215
Fabric COM	COM Fabric	Oak	3-6 weeks	7.30 kg	4.180	5.225
		Walnut			4.528	5.660

Price group	Seat Upholstery	Lead time	PRICE EX. VAT (SEK)	PRICE INC. VAT (SEK)
Fabric gr. 1	Hot Madison, Remix, Re-Wool	3-6 weeks	1.196	1.495
Fabric gr. 2	Canvas, Barnum, Fiord, Ritz	3-6 weeks	1.556	1.945
Fabric gr. 3	Clay, Hallingdal, Steelcut Quartet, Steelcut Trio	3-6 weeks	1.676	2.095
Fabric gr. 4	Acca, Cifrado, Ecriture, Moss, Uniform Melange, Vidar	3-6 weeks	2.032	2.540
Fabric gr. 5	Karakorum, Sisu	3-6 weeks	2.512	3.140
Fabric gr. 6	Fuse, Gentle	3-6 weeks	2.752	3.440
Leather	Tailor Semi-aniline leather	3-6 weeks	1.912	2.390
Leather	Noble Aniline leather	3-6 weeks	2.032	2.540
Leather	Elmosoft Semi-aniline leather	3-6 weeks	2.512	3.140
Fabric COM	COM Fabric	3-6 weeks	1.196	1.495

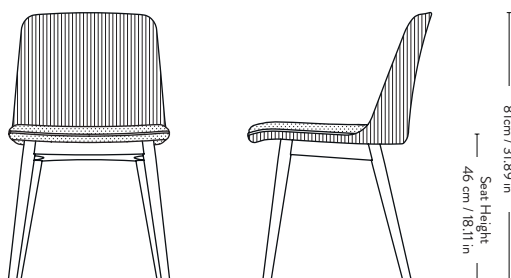

Material: Shell made from 100% recycled polypropylene with fiber glass. Upholstered seats are made with a veneer plate with 30mm HR foam. Water based lacquered oak or walnut base.

Wagner QuickClick Plast gliders are installed as standard.

Wagner QuickClick Felt gliders available upon request.

Fabric usage: 1.2 meters (shell), 0.7 meters (cushion) based on 140cm roll.

Leather usage: 2 square meters (shell), 0.9 square meters (cushion) based on a yield of 60% pr hide.

COM must be approved by &Tradition to ensure suitability for upholstery.

Minimum order quantity of same variant: 4 pcs.



EU Ecolabel certified, validating high standards of durability, circular design, and responsible use of chemicals.

Please contact our sales team for a list of EU Ecolabel

compliant combinations.

Rely ^{HW76} Hee Welling 2022



Item code	Shell Colour	Model	Base	Colli qty.	Lead time	Weight	PRICE EX. VAT (SEK)	PRICE INC. VAT (SEK)
HW	Black	HW76	Oak	1 pc	2-3 weeks	7.00 kg	3.100	3.875
			Walnut				3.456	4.320
HW	White	HW76	Oak	1 pc	2-3 weeks	7.00 kg	3.100	3.875
			Walnut				3.456	4.320
HW	Beige Sand	HW76	Oak	1 pc	2-3 weeks	7.00 kg	3.100	3.875
			Walnut				3.456	4.320
HW	Red Brown	HW76	Oak	1 pc	2-3 weeks	7.00 kg	3.100	3.875
			Walnut				3.456	4.320
HW	Light Blue	HW76	Oak	1 pc	2-3 weeks	7.00 kg	3.100	3.875
			Walnut				3.456	4.320
HW	Stone Grey	HW76	Oak	1 pc	2-3 weeks	7.00 kg	3.100	3.875
			Walnut				3.456	4.320
HW	Vermilion red	HW76	Oak	1 pc	2-3 weeks	7.00 kg	3.100	3.875
			Walnut				3.456	4.320
HW	Bronze green	HW76	Oak	1 pc	2-3 weeks	7.00 kg	3.100	3.875
			Walnut				3.456	4.320
HW	Soft Pink	HW76	Oak	1 pc	2-3 weeks	7.00 kg	3.100	3.875
			Walnut				3.456	4.320

Material: Shell made from 100% recycled polypropylene with fiber glass, Water based lacquered oak or walnut base.

Wagner QuickClick Plast gliders are installed as standard.
Wagner QuickClick Felt gliders available upon request.



EU Ecolabel certified, validating high standards of durability, circular design, and responsible use of chemicals. Please contact our sales team for a list of EU Ecolabel compliant combinations.

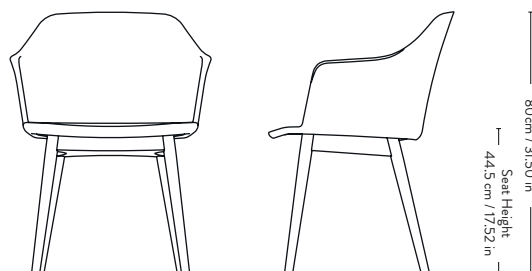

Rely^{HW77} Hee Welling 2022



Price group	Shell Colour	Seat Cushion Upholstery	Base	Lead time	Weight	PRICE EX. VAT (SEK)	PRICE INC. VAT (SEK)
Fabric gr. 1	Black, White, Beige Sand, Red Brown, Light Blue, Stone Grey, Vermilion red, Bronze green, Soft Pink	Hot Madison, Remix, Re-Wool	Oak	6-8 weeks	8.20 kg	4.532	5.665
			Walnut			4.888	6.110
Fabric gr. 2	Black, White, Beige Sand, Red Brown, Light Blue, Stone Grey, Vermilion red, Bronze green, Soft Pink	Canvas, Barnum, Fiord, Ritz	Oak	6-8 weeks	8.20 kg	4.888	6.110
			Walnut			5.248	6.560
Fabric gr. 3	Black, White, Beige Sand, Red Brown, Light Blue, Stone Grey, Vermilion red, Bronze green, Soft Pink	Clay, Hallingdal, Steelcut Quartet, Steelcut Trio	Oak	6-8 weeks	8.20 kg	5.008	6.260
			Walnut			5.368	6.710
Fabric gr. 4	Black, White, Beige Sand, Red Brown, Light Blue, Stone Grey, Vermilion red, Bronze green, Soft Pink	Acca, Cifrado, Ecriture, Moss, Uniform Melange, Vidar	Oak	6-8 weeks	8.20 kg	5.368	6.710
			Walnut			5.724	7.155
Fabric gr. 5	Black, White, Beige Sand, Red Brown, Light Blue, Stone Grey, Vermilion red, Bronze green, Soft Pink	Karakorum, Sisu	Oak	6-8 weeks	8.20 kg	5.844	7.305
			Walnut			6.204	7.755
Fabric gr. 6	Black, White, Beige Sand, Red Brown, Light Blue, Stone Grey, Vermilion red, Bronze green, Soft Pink	Fuse, Gentle	Oak	6-8 weeks	8.20 kg	6.440	8.050
			Walnut			6.800	8.500
Leather	Black, White, Beige Sand, Red Brown, Light Blue, Stone Grey, Vermilion red, Bronze green, Soft Pink	Tailor Semi-aniline leather	Oak	6-8 weeks	8.20 kg	5.008	6.260
			Walnut			5.368	6.710
Leather	Black, White, Beige Sand, Red Brown, Light Blue, Stone Grey, Vermilion red, Bronze green, Soft Pink	Noble Aniline leather	Oak	6-8 weeks	8.20 kg	5.368	6.710
			Walnut			5.724	7.155
Leather	Black, White, Beige Sand, Red Brown, Light Blue, Stone Grey, Vermilion red, Bronze green, Soft Pink	Elmosoft Semi-aniline leather	Oak	6-8 weeks	8.20 kg	5.604	7.005
			Walnut			6.084	7.605
Fabric COM	Black, White, Beige Sand, Red Brown, Light Blue, Stone Grey, Vermilion red, Bronze green, Soft Pink	COM Fabric	Oak	6-8 weeks	8.20 kg	4.532	5.665
			Walnut			4.888	6.110



EU Ecolabel certified, validating high standards of durability, circular design, and responsible use of chemicals. Please contact our sales team for a list of EU Ecolabel compliant combinations.

Material: Shell made from 100% recycled polypropylene with fiber glass, seat covered in HR foam with fabric or leather upholstery. Water based lacquered oak or walnut base.

Wagner QuickClick Plast gliders are installed as standard.
Wagner QuickClick Felt gliders available upon request.

Fabric usage: 0.49 meter based on a 140 cm roll.

Leather usage: 1 square meter based on a yield of 60% pr hide.

COM must be approved by &Tradition to ensure suitability for upholstery.

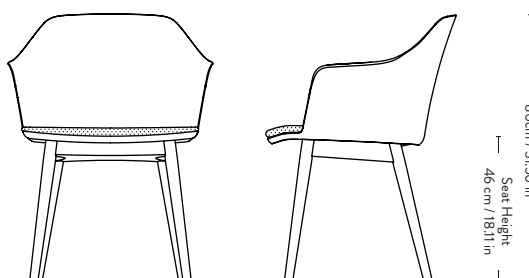

Rely ^{HW78} Hee Welling 2022



Price group	Upholstery	Model	Base	Lead time	Weight	PRICE EX. VAT (SEK)	PRICE INC. VAT (SEK)
Fabric gr. 1	Hot Madison, Remix, Re-Wool	HW78	Oak	6-8 weeks	7.70 kg	5.724	7.155
			Walnut			6.084	7.605
Fabric gr. 2	Canvas, Barnum, Fiord, Ritz	HW78	Oak	6-8 weeks	7.70 kg	6.440	8.050
			Walnut			6.800	8.500
Fabric gr. 3	Clay, Hallingdal, Steelcut Quartet, Steelcut Trio	HW78	Oak	6-8 weeks	7.70 kg	6.680	8.350
			Walnut			7.040	8.800
Fabric gr. 4	Acca, Cifrado, Ecriture, Moss, Uniform Melange, Vidar	HW78	Oak	6-8 weeks	7.70 kg	7.396	9.245
			Walnut			7.756	9.695
Fabric gr. 5	Karakorum, Sisu	HW78	Oak	6-8 weeks	7.70 kg	8.828	11.035
			Walnut			9.188	11.485
Fabric gr. 6	Fuse, Gentle	HW78	Oak	6-8 weeks	7.70 kg	9.664	12.080
			Walnut			10.144	12.680
Leather	Tailor Semi-aniline leather	HW78	Oak	6-8 weeks	7.70 kg	7.756	9.695
			Walnut			8.112	10.140
Leather	Noble Aniline leather	HW78	Oak	6-8 weeks	7.70 kg	9.188	11.485
			Walnut			9.548	11.935
Leather	Elmosoft Semi-aniline leather	HW78	Oak	6-8 weeks	7.70 kg	10.024	12.530
			Walnut			10.384	12.980
Fabric COM	COM Fabric	HW78	Oak	6-8 weeks	7.70 kg	5.724	7.155
			Walnut			6.084	7.605

Material: Shell made from 100% recycled polypropylene with fiber glass, covered with HR foam with fabric or leather upholstery. Water based lacquered oak or walnut base.

Wagner QuickClick Plast gliders are installed as standard.
Wagner QuickClick Felt gliders available upon request.

Fabric usage: 1.5meters based on 140cm roll.

Leather usage: 2.7 square meters based on a yield of 60% pr hide.

COM must be approved by &Tradition to ensure suitability for upholstery.



EU Ecolabel certified, validating high standards of durability, circular design, and responsible use of chemicals. Please contact our sales team for a list of EU Ecolabel compliant combinations.

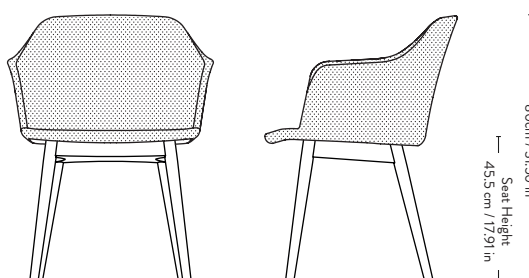

Rely ^{HW79} Hee Welling 2022



Price group	Upholstery	Model	Base	Lead time	Weight	PRICE EX. VAT (SEK)	PRICE INC. VAT (SEK)
Fabric gr. 1	Hot Madison, Remix, Re-Wool	HW79	Oak	6-8 weeks	8.00 kg	6.084	7.605
			Walnut			6.440	8.050
Fabric gr. 2	Canvas, Barnum, Fiord, Ritz	HW79	Oak	6-8 weeks	8.00 kg	6.800	8.500
			Walnut			7.160	8.950
Fabric gr. 3	Clay, Hallingdal, Steelcut Quartet, Steelcut Trio	HW79	Oak	6-8 weeks	8.00 kg	7.040	8.800
			Walnut			7.396	9.245
Fabric gr. 4	Acca, Cifrado, Ecriture, Moss, Uniform Melange, Vidar	HW79	Oak	6-8 weeks	8.00 kg	7.756	9.695
			Walnut			8.112	10.140
Fabric gr. 5	Karakorum, Sisu	HW79	Oak	6-8 weeks	8.00 kg	9.188	11.485
			Walnut			9.548	11.935
Fabric gr. 6	Fuse, Gentle	HW79	Oak	6-8 weeks	8.00 kg	10.144	12.680
			Walnut			10.500	13.125
Leather	Tailor Semi-aniline leather	HW79	Oak	6-8 weeks	8.00 kg	8.112	10.140
			Walnut			8.472	10.590
Leather	Noble Aniline leather	HW79	Oak	6-8 weeks	8.00 kg	9.548	11.935
			Walnut			9.904	12.380
Leather	Elmosoft Semi-aniline leather	HW79	Oak	6-8 weeks	8.00 kg	10.620	13.275
			Walnut			10.980	13.725
Fabric COM	COM Fabric	HW79	Oak	6-8 weeks	8.00 kg	6.084	7.605
			Walnut			6.440	8.050

Material: Shell made from 100% recycled polypropylene with fiber glass, covered with HR foam with fabric or leather upholstery. Water based lacquered oak or walnut base.

Wagner QuickClick Plast gliders are installed as standard.
Wagner QuickClick Felt gliders available upon request.

Fabric usage: 2.3 meters based on 140cm roll.

Leather usage: 3.4 square meters based on a yield of 60% pr hide.

COM must be approved by &Tradition to ensure suitability for upholstery.



EU Ecolabel certified, validating high standards of durability, circular design, and responsible use of chemicals. Please contact our sales team for a list of EU Ecolabel compliant combinations.

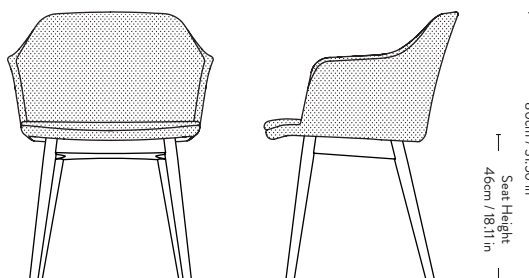

Rely ^{HW80} Hee Welling 2022



Please note that price is accumulated price of shell & seat.

Price group	Shell Upholstery	Base	Lead time	Weight	PRICE EX. VAT (SEK)	PRICE INC. VAT (SEK)
Fabric gr. 1	Hot Madison, Remix, Re-Wool	Oak	3-6 weeks	8.00 kg	4.896	6.120
		Walnut			5.244	6.555
Fabric gr. 2	Canvas, Barnum, Fiord, Ritz	Oak	3-6 weeks	8.00 kg	5.256	6.570
		Walnut			5.608	7.010
Fabric gr. 3	Clay, Hallingdal, Steelcut Quartet, Steelcut Trio	Oak	3-6 weeks	8.00 kg	5.376	6.720
		Walnut			5.732	7.165
Fabric gr. 4	Acca, Cifrado, Ecriture, Moss, Uniform Melange, Vidar	Oak	3-6 weeks	8.00 kg	5.728	7.160
		Walnut			6.092	7.615
Fabric gr. 5	Karakorum, Sisu	Oak	3-6 weeks	8.00 kg	6.692	8.365
		Walnut			7.048	8.810
Fabric gr. 6	Fuse, Gentle	Oak	3-6 weeks	8.00 kg	7.408	9.260
		Walnut			7.752	9.690
Leather	Tailor Semi-aniline leather	Oak	3-6 weeks	8.00 kg	6.200	7.750
		Walnut			6.572	8.215
Leather	Noble Aniline leather	Oak	3-6 weeks	8.00 kg	7.520	9.400
		Walnut			7.888	9.860
Leather	Elmosoft Semi-aniline leather	Oak	3-6 weeks	8.00 kg	8.124	10.155
		Walnut			8.484	10.605
Fabric COM	COM Fabric	Oak	3-6 weeks	8.00 kg	4.896	6.120
		Walnut			5.244	6.555

Price group	Seat Upholstery	Lead time	PRICE EX. VAT (SEK)	PRICE INC. VAT (SEK)
Fabric gr. 1	Hot Madison, Remix, Re-Wool	3-6 weeks	1.196	1.495
Fabric gr. 2	Canvas, Barnum, Fiord, Ritz	3-6 weeks	1.556	1.945
Fabric gr. 3	Clay, Hallingdal, Steelcut Quartet, Steelcut Trio	3-6 weeks	1.676	2.095
Fabric gr. 4	Acca, Cifrado, Ecriture, Moss, Uniform Melange, Vidar	3-6 weeks	2.032	2.540
Fabric gr. 5	Karakorum, Sisu	3-6 weeks	2.512	3.140
Fabric gr. 6	Fuse, Gentle	3-6 weeks	2.752	3.440
Leather	Tailor Semi-aniline leather	3-6 weeks	1.912	2.390
Leather	Noble Aniline leather	3-6 weeks	2.032	2.540
Leather	Elmosoft Semi-aniline leather	3-6 weeks	2.512	3.140
Fabric COM	COM Fabric	3-6 weeks	1.196	1.495

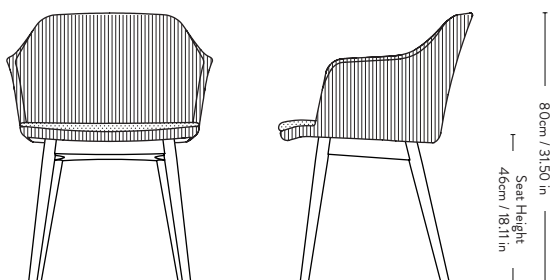

Material: Shell made from 100% recycled polypropylene with fiber glass, covered with HR foam with fabric or leather upholstery. Water based lacquered oak or walnut base.

Wagner QuickClick Plast gliders are installed as standard.

Wagner QuickClick Felt gliders available upon request.

Fabric usage: 1.5 meters (shell), 0.77 meters (cushion) based on 140cm roll.

Leather usage: 2.64 square meters (shell), 0.77 square meters (cushion) based on a yield of 60% pr hide.

COM must be approved by &Tradition to ensure suitability for upholstery.

Minimum order quantity of same variant: 4 pcs.



EU Ecolabel certified, validating high standards of durability, circular design, and responsible use of chemicals.

Please contact our sales team for a list of EU Ecolabel

compliant combinations.

Rely ^{HW81} Hee Welling 2022



Item code	Shell Colour	Model	Base	Colli qty.	Lead time	Weight	PRICE EX. VAT (SEK)	PRICE INC. VAT (SEK)
HW	Black	HW81	Black, Bronzed	1 pc	2-3 weeks	5.30 kg	2.740	3.425
HW	White	HW81	Black, Bronzed	1 pc	2-3 weeks	5.30 kg	2.740	3.425
HW	Beige Sand	HW81	Black, Bronzed	1 pc	2-3 weeks	5.30 kg	2.740	3.425
HW	Red Brown	HW81	Black, Bronzed	1 pc	2-3 weeks	5.30 kg	2.740	3.425
HW	Light Blue	HW81	Black, Bronzed	1 pc	2-3 weeks	5.30 kg	2.740	3.425
HW	Stone Grey	HW81	Black, Bronzed	1 pc	2-3 weeks	5.30 kg	2.740	3.425

Material: Shell made from 100% recycled polypropylene with fiber glass and a steel tube base.

Wagner QuickClick Plast gliders are installed as standard.
Wagner QuickClick Felt gliders available upon request.



EU Ecolabel certified, validating high standards of durability, circular design, and responsible use of chemicals. Please contact our sales team for a list of EU Ecolabel compliant combinations.

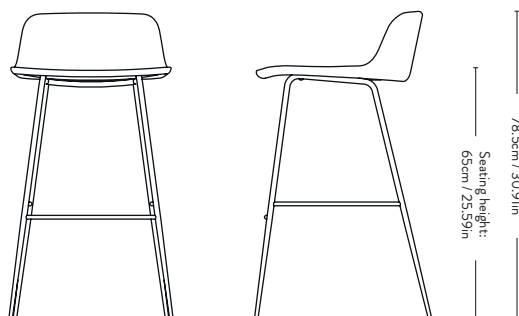

Rely ^{HW82} Hee Welling 2022



Price group	Shell Colour	Seat Cushion Upholstery	Base	Lead time	Weight	PRICE EX. VAT (SEK)	PRICE INC. VAT (SEK)
Fabric gr. 1	Black, White, Beige Sand, Red Brown, Light Blue, Stone Grey	Hot Madison, Remix, Re-Wool	Black, Bronzed	3-6 weeks	6.00 kg	3.936	4.920
Fabric gr. 2	Black, White, Beige Sand, Red Brown, Light Blue, Stone Grey	Canvas, Barnum, Fiord, Ritz	Black, Bronzed	3-6 weeks	6.00 kg	4.292	5.365
Fabric gr. 3	Black, White, Beige Sand, Red Brown, Light Blue, Stone Grey	Clay, Hallingdal, Steelcut Quartet, Steelcut Trio	Black, Bronzed	3-6 weeks	6.00 kg	4.412	5.515
Fabric gr. 4	Black, White, Beige Sand, Red Brown, Light Blue, Stone Grey	Acca, Cifrado, Ecriture, Moss, Uniform Melange, Vidar	Black, Bronzed	3-6 weeks	6.00 kg	4.772	5.965
Fabric gr. 5	Black, White, Beige Sand, Red Brown, Light Blue, Stone Grey	Karakorum, Sisu	Black, Bronzed	3-6 weeks	6.00 kg	5.248	6.560
Fabric gr. 6	Black, White, Beige Sand, Red Brown, Light Blue, Stone Grey	Fuse, Gentle	Black, Bronzed	3-6 weeks	6.00 kg	5.724	7.155
Leather	Black, White, Beige Sand, Red Brown, Light Blue, Stone Grey	Tailor Semi-aniline leather	Black, Bronzed	3-6 weeks	6.00 kg	4.412	5.515
Leather	Black, White, Beige Sand, Red Brown, Light Blue, Stone Grey	Noble Aniline leather	Black, Bronzed	3-6 weeks	6.00 kg	4.772	5.965
Leather	Black, White, Beige Sand, Red Brown, Light Blue, Stone Grey	Elmosoft Semi-aniline leather	Black, Bronzed	3-6 weeks	6.00 kg	5.128	6.410
Fabric COM	Black, White, Beige Sand, Red Brown, Light Blue, Stone Grey	COM Fabric	Black, Bronzed	3-6 weeks	6.00 kg	3.936	4.920

Material: Shell made from 100% recycled polypropylene with fiber glass, HR foam seat covered with fabric or leather upholstery, steel tube base.

Wagner QuickClick Plast gliders are installed as standard.
Wagner QuickClick Felt gliders available upon request.

Fabric usage: 0.49 meter based on a 140 cm roll.

Leather usage: 1 square meter based on a yield of 60% pr hide.

COM must be approved by &Tradition to ensure suitability for upholstery.



EU Ecolabel certified, validating high standards of durability, circular design, and responsible use of chemicals. Please contact our sales team for a list of EU Ecolabel compliant combinations.

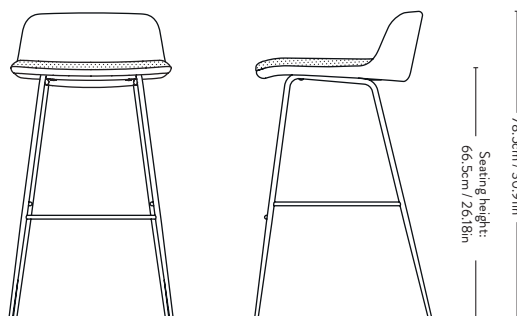

Rely ^{HW83} Hee Welling 2022



Price group	Upholstery	Model	Base	Lead time	Weight	PRICE EX. VAT (SEK)	PRICE INC. VAT (SEK)
Fabric gr. 1	Hot Madison, Remix, Re-Wool	HW83	Black, Bronzed	3-6 weeks	5.60 kg	4.772	5.965
Fabric gr. 2	Canvas, Barnum, Fiord, Ritz	HW83	Black, Bronzed	3-6 weeks	5.60 kg	5.488	6.860
Fabric gr. 3	Clay, Hallingdal, Steelcut Quartet, Steelcut Trio	HW83	Black, Bronzed	3-6 weeks	5.60 kg	5.724	7.155
Fabric gr. 4	Acca, Cifrado, Ecriture, Moss, Uniform Melange, Vidar	HW83	Black, Bronzed	3-6 weeks	5.60 kg	6.324	7.905
Fabric gr. 5	Karakorum, Sisu	HW83	Black, Bronzed	3-6 weeks	5.60 kg	7.756	9.695
Fabric gr. 6	Fuse, Gentle	HW83	Black, Bronzed	3-6 weeks	5.60 kg	8.472	10.590
Leather	Tailor Semi-aniline leather	HW83	Black, Bronzed	3-6 weeks	5.60 kg	6.680	8.350
Leather	Noble Aniline leather	HW83	Black, Bronzed	3-6 weeks	5.60 kg	7.040	8.800
Leather	Elmosoft Semi-aniline leather	HW83	Black, Bronzed	3-6 weeks	5.60 kg	7.636	9.545
Fabric COM	COM Fabric	HW83	Black, Bronzed	3-6 weeks	5.60 kg	4.772	5.965

Material: Shell made from 100% recycled polypropylene with fiber glass, covered with HR foam with fabric or leather upholstery, steel tube base.

Wagner QuickClick Plast gliders are installed as standard.
Wagner QuickClick Felt gliders available upon request.

Fabric usage: 1.1 meters based on 140cm roll.

Leather usage: 1.7 square meters based on a yield of 60% pr hide.

COM must be approved by &Tradition to ensure suitability for upholstery.



EU Ecolabel certified, validating high standards of durability, circular design, and responsible use of chemicals. Please contact our sales team for a list of EU Ecolabel compliant combinations.

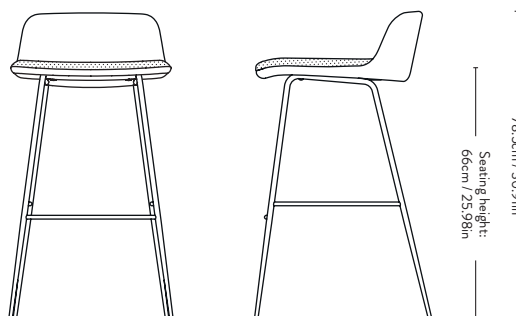

Rely ^{HW84} Hee Welling 2022



Price group	Upholstery	Model	Base	Lead time	Weight	PRICE EX. VAT (SEK)	PRICE INC. VAT (SEK)
Fabric gr. 1	Hot Madison, Remix, Re-Wool	HW84	Black, Bronzed	3-6 weeks	6.20 kg	5.008	6.260
Fabric gr. 2	Canvas, Barnum, Fiord, Ritz	HW84	Black, Bronzed	3-6 weeks	6.20 kg	5.724	7.155
Fabric gr. 3	Clay, Hallingdal, Steelcut Quartet, Steelcut Trio	HW84	Black, Bronzed	3-6 weeks	6.20 kg	5.964	7.455
Fabric gr. 4	Acca, Cifrado, Ecriture, Moss, Uniform Melange, Vidar	HW84	Black, Bronzed	3-6 weeks	6.20 kg	6.560	8.200
Fabric gr. 5	Karakorum, Sisu	HW84	Black, Bronzed	3-6 weeks	6.20 kg	7.996	9.995
Fabric gr. 6	Fuse, Gentle	HW84	Black, Bronzed	3-6 weeks	6.20 kg	8.828	11.035
Leather	Tailor Semi-aniline leather	HW84	Black, Bronzed	3-6 weeks	6.20 kg	6.920	8.650
Leather	Noble Aniline leather	HW84	Black, Bronzed	3-6 weeks	6.20 kg	7.276	9.095
Leather	Elmosoft Semi-aniline leather	HW84	Black, Bronzed	3-6 weeks	6.20 kg	7.996	9.995
Fabric COM	COM Fabric	HW84	Black, Bronzed	3-6 weeks	6.20 kg	5.008	6.260

Material: Shell made from 100% recycled polypropylene with fiber glass, covered with HR foam with fabric or leather upholstery, steel tube base.

Wagner QuickClick Plast gliders are installed as standard.
Wagner QuickClick Felt gliders available upon request.

Fabric usage: 1.8 meters based on a 140cm roll.

Leather usage: 2.2 square meters based on a yield of 60% pr hide.

COM must be approved by &Tradition to ensure suitability for upholstery.



EU Ecolabel certified, validating high standards of durability, circular design, and responsible use of chemicals. Please contact our sales team for a list of EU Ecolabel compliant combinations.

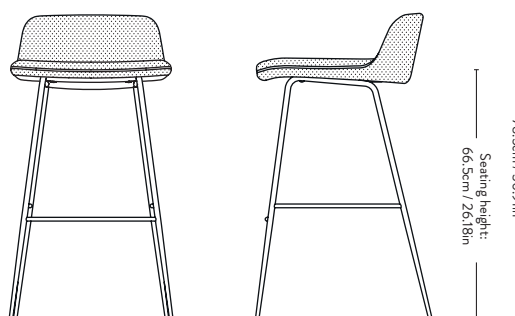

Rely ^{HW85} Hee Welling 2022



Please note that price is accumulated price of shell & seat.

Price group	Shell Upholstery	Base	Lead time	Weight	PRICE EX. VAT (SEK)	PRICE INC. VAT (SEK)
Fabric gr. 1	Hot Madison, Remix, Re-Wool	Black, Bronzed	3-6 weeks	10.50 kg	3.812	4.765
Fabric gr. 2	Canvas, Barnum, Fiord, Ritz	Black, Bronzed	3-6 weeks	10.50 kg	4.180	5.225
Fabric gr. 3	Clay, Hallingdal, Steelcut Quartet, Steelcut Trio	Black, Bronzed	3-6 weeks	10.50 kg	4.300	5.375
Fabric gr. 4	Acca, Cifrado, Ecriture, Moss, Uniform Melange, Vidar	Black, Bronzed	3-6 weeks	10.50 kg	4.540	5.675
Fabric gr. 5	Karakorum, Sisu	Black, Bronzed	3-6 weeks	10.50 kg	5.496	6.870
Fabric gr. 6	Fuse, Gentle	Black, Bronzed	3-6 weeks	10.50 kg	6.080	7.600
Leather	Tailor Semi-aniline leather	Black, Bronzed	3-6 weeks	10.50 kg	5.016	6.270
Leather	Noble Aniline leather	Black, Bronzed	3-6 weeks	10.50 kg	5.256	6.570
Leather	Elmosoft Semi-aniline leather	Black, Bronzed	3-6 weeks	10.50 kg	5.496	6.870
Fabric COM	COM Fabric	Black, Bronzed	3-6 weeks	10.50 kg	3.812	4.765

Price group	Seat Upholstery	Lead time	PRICE EX. VAT (SEK)	PRICE INC. VAT (SEK)
Fabric gr. 1	Hot Madison, Remix, Re-Wool	3-6 weeks	1.196	1.495
Fabric gr. 2	Canvas, Barnum, Fiord, Ritz	3-6 weeks	1.556	1.945
Fabric gr. 3	Clay, Hallingdal, Steelcut Quartet, Steelcut Trio	3-6 weeks	1.676	2.095
Fabric gr. 4	Acca, Cifrado, Ecriture, Moss, Uniform Melange, Vidar	3-6 weeks	2.032	2.540
Fabric gr. 5	Karakorum, Sisu	3-6 weeks	2.512	3.140
Fabric gr. 6	Fuse, Gentle	3-6 weeks	2.752	3.440
Leather	Tailor Semi-aniline leather	3-6 weeks	1.912	2.390
Leather	Noble Aniline leather	3-6 weeks	2.032	2.540
Leather	Elmosoft Semi-aniline leather	3-6 weeks	2.512	3.140
Fabric COM	COM Fabric	3-6 weeks	1.196	1.495

Material: Shell made from 100% recycled polypropylene with fiber glass, covered with HR foam with fabric or leather upholstery, steel tube base.

Wagner QuickClick Plast gliders are installed as standard.
Wagner QuickClick Felt gliders available upon request.

Fabric usage: 1.3 meters (shell), 0.8 meters (cushion) based on 140cm roll.
Leather usage: 2.3 square meters (shell), 0.7 square meters (cushion) based on a yield of 60% pr hide.

COM must be approved by &Tradition to ensure suitability for upholstery.

Minimum order quantity of same variant: 4 pcs.



EU Ecolabel certified, validating high standards of durability, circular design, and responsible use of chemicals. Please contact our sales team for a list of EU Ecolabel compliant combinations.



Rely ^{HW86} Hee Welling 2022



Item code	Shell Colour	Model	Base	Colli qty.	Lead time	Weight	PRICE EX. VAT (SEK)	PRICE INC. VAT (SEK)
HW	Black	HW86	Black, Bronzed	1 pc	2-3 weeks	5.50 kg	2.740	3.425
HW	White	HW86	Black, Bronzed	1 pc	2-3 weeks	5.50 kg	2.740	3.425
HW	Beige Sand	HW86	Black, Bronzed	1 pc	2-3 weeks	5.50 kg	2.740	3.425
HW	Red Brown	HW86	Black, Bronzed	1 pc	2-3 weeks	5.50 kg	2.740	3.425
HW	Light Blue	HW86	Black, Bronzed	1 pc	2-3 weeks	5.50 kg	2.740	3.425
HW	Stone Grey	HW86	Black, Bronzed	1 pc	2-3 weeks	5.50 kg	2.740	3.425

Material: Shell made from 100% recycled polypropylene with fiber glass and a steel tube base.

Wagner QuickClick Plast gliders are installed as standard.
Wagner QuickClick Felt gliders available upon request.



EU Ecolabel certified, validating high standards of durability, circular design, and responsible use of chemicals. Please contact our sales team for a list of EU Ecolabel compliant combinations.

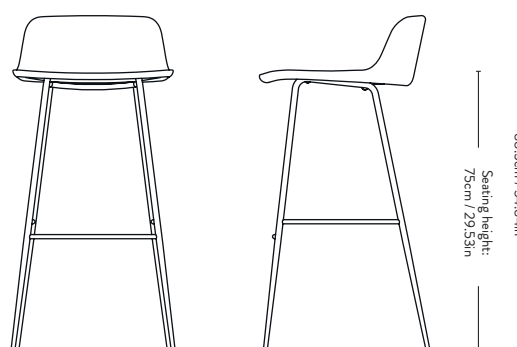

49cm / 17.32in 45cm / 17.72in Seating depth: 45cm / 17.72in
22% RABATT SKA DRAS AV PÅ ANGIVNA PRISER

Rely ^{HW87} Hee Welling 2022



Price group	Shell Colour	Seat Cushion Upholstery	Base	Lead time	Weight	PRICE EX. VAT (SEK)	PRICE INC. VAT (SEK)
Fabric gr. 1	Black, White, Beige Sand, Red Brown, Light Blue, Stone Grey	Hot Madison, Remix, Re-Wool	Black, Bronzed	3-6 weeks	6.30 kg	3.936	4.920
Fabric gr. 2	Black, White, Beige Sand, Red Brown, Light Blue, Stone Grey	Canvas, Barnum, Fiord, Ritz	Black, Bronzed	3-6 weeks	6.30 kg	4.292	5.365
Fabric gr. 3	Black, White, Beige Sand, Red Brown, Light Blue, Stone Grey	Clay, Hallingdal, Steelcut Quartet, Steelcut Black, Bronzed Trio	Black, Bronzed	3-6 weeks	6.30 kg	4.412	5.515
Fabric gr. 4	Black, White, Beige Sand, Red Brown, Light Blue, Stone Grey	Acca, Cifrado, Ecriture, Moss, Uniform Melange, Vidar	Black, Bronzed	3-6 weeks	6.30 kg	4.772	5.965
Fabric gr. 5	Black, White, Beige Sand, Red Brown, Light Blue, Stone Grey	Karakorum, Sisu	Black, Bronzed	3-6 weeks	6.30 kg	5.248	6.560
Fabric gr. 6	Black, White, Beige Sand, Red Brown, Light Blue, Stone Grey	Fuse, Gentle	Black, Bronzed	3-6 weeks	6.30 kg	5.724	7.155
Leather	Black, White, Beige Sand, Red Brown, Light Blue, Stone Grey	Tailor Semi-aniline leather	Black, Bronzed	3-6 weeks	6.30 kg	4.412	5.515
Leather	Black, White, Beige Sand, Red Brown, Light Blue, Stone Grey	Noble Aniline leather	Black, Bronzed	3-6 weeks	6.30 kg	4.772	5.965
Leather	Black, White, Beige Sand, Red Brown, Light Blue, Stone Grey	Elmosoft Semi-aniline leather	Black, Bronzed	3-6 weeks	6.30 kg	5.128	6.410
Fabric COM	Black, White, Beige Sand, Red Brown, Light Blue, Stone Grey	COM Fabric	Black, Bronzed	3-6 weeks	6.30 kg	3.936	4.920

Material: Shell made from 100% recycled polypropylene with fiber glass, HR foam seat covered with fabric or leather upholstery, steel tube base.

Wagner QuickClick Plast gliders are installed as standard.
Wagner QuickClick Felt gliders available upon request.

Fabric usage: 0.49 meter based on a 140 cm roll.

Leather usage: 1 square meter based on a yield of 60% pr hide.

COM must be approved by &Tradition to ensure suitability for upholstery.



EU Ecolabel certified, validating high standards of durability, circular design, and responsible use of chemicals. Please contact our sales team for a list of EU Ecolabel compliant combinations.

Rely ^{HW88} Hee Welling 2022



Price group	Upholstery	Model	Base	Lead time	Weight	PRICE EX. VAT (SEK)	PRICE INC. VAT (SEK)
Fabric gr. 1	Hot Madison, Remix, Re-Wool	HW88	Black, Bronzed	3-6 weeks	5.80 kg	4.772	5.965
Fabric gr. 2	Canvas, Barnum, Fiord, Ritz	HW88	Black, Bronzed	3-6 weeks	5.80 kg	5.488	6.860
Fabric gr. 3	Clay, Hallingdal, Steelcut Quartet, Steelcut Trio	HW88	Black, Bronzed	3-6 weeks	5.80 kg	5.724	7.155
Fabric gr. 4	Acca, Cifrado, Ecriture, Moss, Uniform Melange, Vidar	HW88	Black, Bronzed	3-6 weeks	5.80 kg	6.324	7.905
Fabric gr. 5	Karakorum, Sisu	HW88	Black, Bronzed	3-6 weeks	5.80 kg	7.756	9.695
Fabric gr. 6	Fuse, Gentle	HW88	Black, Bronzed	3-6 weeks	5.80 kg	8.472	10.590
Leather	Tailor Semi-aniline leather	HW88	Black, Bronzed	3-6 weeks	5.80 kg	6.680	8.350
Leather	Noble Aniline leather	HW88	Black, Bronzed	3-6 weeks	5.80 kg	7.040	8.800
Leather	Elmosoft Semi-aniline leather	HW88	Black, Bronzed	3-6 weeks	5.80 kg	7.636	9.545
Fabric COM	COM Fabric	HW88	Black, Bronzed	3-6 weeks	5.80 kg	4.772	5.965

Material: Shell made from 100% recycled polypropylene with fiber glass, covered with HR foam with fabric or leather upholstery, steel tube base.

Wagner QuickClick Plast gliders are installed as standard.
Wagner QuickClick Felt gliders available upon request.

Fabric usage: 1.1 meters based on 140cm roll.

Leather usage: 1.7 square meters based on a yield of 60% pr hide.

COM must be approved by &Tradition to ensure suitability for upholstery.



EU Ecolabel certified, validating high standards of durability, circular design, and responsible use of chemicals. Please contact our sales team for a list of EU Ecolabel compliant combinations.



Rely ^{HW89} Hee Welling 2022



Price group	Upholstery	Model	Base	Lead time	Weight	PRICE EX. VAT (SEK)	PRICE INC. VAT (SEK)
Fabric gr. 1	Hot Madison, Remix, Re-Wool	HW89	Black, Bronzed	3-6 weeks	6.50 kg	5.008	6.260
Fabric gr. 2	Canvas, Barnum, Fiord, Ritz	HW89	Black, Bronzed	3-6 weeks	6.50 kg	5.724	7.155
Fabric gr. 3	Clay, Hallingdal, Steelcut Quartet, Steelcut Trio	HW89	Black, Bronzed	3-6 weeks	6.50 kg	5.964	7.455
Fabric gr. 4	Acca, Cifrado, Ecriture, Moss, Uniform Melange, Vidar	HW89	Black, Bronzed	3-6 weeks	6.50 kg	6.560	8.200
Fabric gr. 5	Karakorum, Sisu	HW89	Black, Bronzed	3-6 weeks	6.50 kg	7.996	9.995
Fabric gr. 6	Fuse, Gentle	HW89	Black, Bronzed	3-6 weeks	6.50 kg	8.828	11.035
Leather	Tailor Semi-aniline leather	HW89	Black, Bronzed	3-6 weeks	6.50 kg	6.920	8.650
Leather	Noble Aniline leather	HW89	Black, Bronzed	3-6 weeks	6.50 kg	7.276	9.095
Leather	Elmosoft Semi-aniline leather	HW89	Black, Bronzed	3-6 weeks	6.50 kg	7.996	9.995
Fabric COM	COM Fabric	HW89	Black, Bronzed	3-6 weeks	6.50 kg	5.008	6.260

Material: Shell made from 100% recycled polypropylene with fiber glass, covered with HR foam with fabric or leather upholstery, steel tube base.

Wagner QuickClick Plast gliders are installed as standard.
Wagner QuickClick Felt gliders available upon request.

Fabric usage: 1.8 meters based on a 140cm roll.

Leather usage: 2.2 square meters based on a yield of 60% pr hide.

COM must be approved by &Tradition to ensure suitability for upholstery.



EU Ecolabel certified, validating high standards of durability, circular design, and responsible use of chemicals. Please contact our sales team for a list of EU Ecolabel compliant combinations.



Rely ^{HW90} Hee Welling 2022



Please note that price is accumulated price of shell & seat.

Price group	Shell Upholstery	Base	Lead time	Weight	PRICE EX. VAT (SEK)	PRICE INC. VAT (SEK)
Fabric gr. 1	Hot Madison, Remix, Re-Wool	Black, Bronzed	3-6 weeks	10.50 kg	3.812	4.765
Fabric gr. 2	Canvas, Barnum, Fiord, Ritz	Black, Bronzed	3-6 weeks	10.50 kg	4.180	5.225
Fabric gr. 3	Clay, Hallingdal, Steelcut Quartet, Steelcut Trio	Black, Bronzed	3-6 weeks	10.50 kg	4.300	5.375
Fabric gr. 4	Acca, Cifrado, Ecriture, Moss, Uniform Melange, Vidar	Black, Bronzed	3-6 weeks	10.50 kg	4.540	5.675
Fabric gr. 5	Karakorum, Sisu	Black, Bronzed	3-6 weeks	10.50 kg	5.496	6.870
Fabric gr. 6	Fuse, Gentle	Black, Bronzed	3-6 weeks	10.50 kg	6.080	7.600
Leather	Tailor Semi-aniline leather	Black, Bronzed	3-6 weeks	10.50 kg	5.016	6.270
Leather	Noble Aniline leather	Black, Bronzed	3-6 weeks	10.50 kg	5.256	6.570
Leather	Elmosoft Semi-aniline leather	Black, Bronzed	3-6 weeks	10.50 kg	5.496	6.870
Fabric COM	COM Fabric	Black, Bronzed	3-6 weeks	10.50 kg	3.812	4.765

Price group	Seat Upholstery	Lead time	PRICE EX. VAT (SEK)	PRICE INC. VAT (SEK)
Fabric gr. 1	Hot Madison, Remix, Re-Wool	3-6 weeks	1.196	1.495
Fabric gr. 2	Canvas, Barnum, Fiord, Ritz	3-6 weeks	1.556	1.945
Fabric gr. 3	Clay, Hallingdal, Steelcut Quartet, Steelcut Trio	3-6 weeks	1.676	2.095
Fabric gr. 4	Acca, Cifrado, Ecriture, Moss, Uniform Melange, Vidar	3-6 weeks	2.032	2.540
Fabric gr. 5	Karakorum, Sisu	3-6 weeks	2.512	3.140
Fabric gr. 6	Fuse, Gentle	3-6 weeks	2.752	3.440
Leather	Tailor Semi-aniline leather	3-6 weeks	1.912	2.390
Leather	Noble Aniline leather	3-6 weeks	2.032	2.540
Leather	Elmosoft Semi-aniline leather	3-6 weeks	2.512	3.140
Fabric COM	COM Fabric	3-6 weeks	1.196	1.495

Material: Shell made from 100% recycled polypropylene with fiber glass, covered with HR foam with fabric or leather upholstery, steel tube base.

Wagner QuickClick Plast gliders are installed as standard.
Wagner QuickClick Felt gliders available upon request.

Fabric usage: 1.3 meters (shell), 0.8 meters (cushion) based on 140cm roll.
Leather usage: 2.3 square meters (shell), 0.7 square meters (cushion) based on a yield of 60% pr hide.

COM must be approved by &Tradition to ensure suitability for upholstery.

Minimum order quantity of same variant: 4 pcs.



EU Ecolabel certified, validating high standards of durability, circular design, and responsible use of chemicals. Please contact our sales team for a list of EU Ecolabel compliant combinations.



Rely ^{HW91} Hee Welling 2022



Item code	Shell Colour	Model	Base	Colli qty.	Lead time	Weight	PRICE EX. VAT (SEK)	PRICE INC. VAT (SEK)
HW	Black	HW91	Black, Bronzed	1 pc	2-3 weeks	7.10 kg	2.980	3.725
HW	White	HW91	Black, Bronzed	1 pc	2-3 weeks	7.10 kg	2.980	3.725
HW	Beige Sand	HW91	Black, Bronzed	1 pc	2-3 weeks	7.10 kg	2.980	3.725
HW	Red Brown	HW91	Black, Bronzed	1 pc	2-3 weeks	7.10 kg	2.980	3.725
HW	Light Blue	HW91	Black, Bronzed	1 pc	2-3 weeks	7.10 kg	2.980	3.725
HW	Stone Grey	HW91	Black, Bronzed	1 pc	2-3 weeks	7.10 kg	2.980	3.725

Material: Shell made from 100% recycled polypropylene with fiber glass and a steel tube base.

Wagner QuickClick Plast gliders are installed as standard.
Wagner QuickClick Felt gliders available upon request.



EU Ecolabel certified, validating high standards of durability, circular design, and responsible use of chemicals. Please contact our sales team for a list of EU Ecolabel compliant combinations.

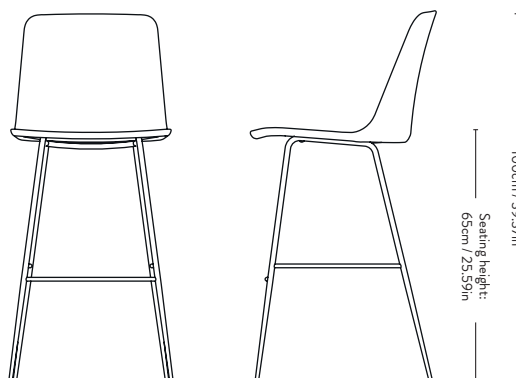

Rely ^{HW92} Hee Welling 2022



Price group	Shell Colour	Seat Cushion Upholstery	Base	Lead time	Weight	PRICE EX. VAT (SEK)	PRICE INC. VAT (SEK)
Fabric gr. 1	Black, White, Beige Sand, Red Brown, Light Blue, Stone Grey	Hot Madison, Remix, Re-Wool	Black, Bronzed	3-6 weeks	7.90 kg	4.172	5.215
Fabric gr. 2	Black, White, Beige Sand, Red Brown, Light Blue, Stone Grey	Canvas, Barnum, Fiord, Ritz	Black, Bronzed	3-6 weeks	7.90 kg	4.532	5.665
Fabric gr. 3	Black, White, Beige Sand, Red Brown, Light Blue, Stone Grey	Clay, Hallingdal, Steelcut Quartet, Steelcut Black, Bronzed Trio	Black, Bronzed	3-6 weeks	7.90 kg	4.652	5.815
Fabric gr. 4	Black, White, Beige Sand, Red Brown, Light Blue, Stone Grey	Acca, Cifrado, Ecriture, Moss, Uniform Melange, Vidar	Black, Bronzed	3-6 weeks	7.90 kg	5.008	6.260
Fabric gr. 5	Black, White, Beige Sand, Red Brown, Light Blue, Stone Grey	Karakorum, Sisu	Black, Bronzed	3-6 weeks	7.90 kg	5.488	6.860
Fabric gr. 6	Black, White, Beige Sand, Red Brown, Light Blue, Stone Grey	Fuse, Gentle	Black, Bronzed	3-6 weeks	7.90 kg	6.084	7.605
Leather	Black, White, Beige Sand, Red Brown, Light Blue, Stone Grey	Tailor Semi-aniline leather	Black, Bronzed	3-6 weeks	7.90 kg	4.652	5.815
Leather	Black, White, Beige Sand, Red Brown, Light Blue, Stone Grey	Noble Aniline leather	Black, Bronzed	3-6 weeks	7.90 kg	5.008	6.260
Leather	Black, White, Beige Sand, Red Brown, Light Blue, Stone Grey	Elmosoft Semi-aniline leather	Black, Bronzed	3-6 weeks	7.90 kg	5.368	6.710
Fabric COM	Black, White, Beige Sand, Red Brown, Light Blue, Stone Grey	COM Fabric	Black, Bronzed	3-6 weeks	7.90 kg	4.172	5.215

Material: Shell made from 100% recycled polypropylene with fiber glass, HR foam seat covered with fabric or leather upholstery, steel tube base.

Wagner QuickClick Plast gliders are installed as standard.
Wagner QuickClick Felt gliders available upon request.

Fabric usage: 0.49 meter based on a 140 cm roll.

Leather usage: 1 square meter based on a yield of 60% pr hide.

COM must be approved by &Tradition to ensure suitability for upholstery.



EU Ecolabel certified, validating high standards of durability, circular design, and responsible use of chemicals. Please contact our sales team for a list of EU Ecolabel compliant combinations.

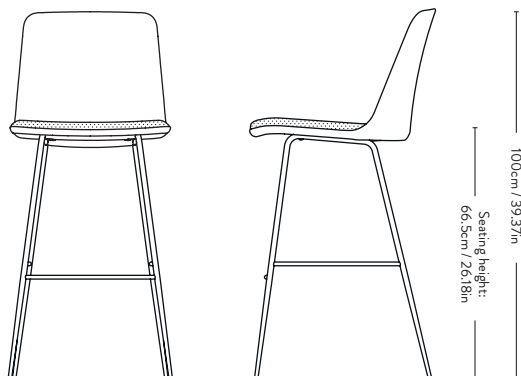

Rely ^{HW93} Hee Welling 2022



Price group	Upholstery	Model	Base	Lead time	Weight	PRICE EX. VAT (SEK)	PRICE INC. VAT (SEK)
Fabric gr. 1	Hot Madison, Remix, Re-Wool	HW93	Black, Bronzed	3-6 weeks	7.60 kg	5.128	6.410
Fabric gr. 2	Canvas, Barnum, Fiord, Ritz	HW93	Black, Bronzed	3-6 weeks	7.60 kg	5.844	7.305
Fabric gr. 3	Clay, Hallingdal, Steelcut Quartet, Steelcut Trio	HW93	Black, Bronzed	3-6 weeks	7.60 kg	6.084	7.605
Fabric gr. 4	Acca, Cifrado, Ecriture, Moss, Uniform Melange, Vidar	HW93	Black, Bronzed	3-6 weeks	7.60 kg	6.680	8.350
Fabric gr. 5	Karakorum, Sisu	HW93	Black, Bronzed	3-6 weeks	7.60 kg	8.112	10.140
Fabric gr. 6	Fuse, Gentle	HW93	Black, Bronzed	3-6 weeks	7.60 kg	8.948	11.185
Leather	Tailor Semi-aniline leather	HW93	Black, Bronzed	3-6 weeks	7.60 kg	7.040	8.800
Leather	Noble Aniline leather	HW93	Black, Bronzed	3-6 weeks	7.60 kg	7.396	9.245
Leather	Elmosoft Semi-aniline leather	HW93	Black, Bronzed	3-6 weeks	7.60 kg	7.996	9.995
Fabric COM	COM Fabric	HW93	Black, Bronzed	3-6 weeks	7.60 kg	5.128	6.410

Material: Shell made from 100% recycled polypropylene with fiber glass, covered with HR foam with fabric or leather upholstery, steel tube base.

Wagner QuickClick Plast gliders are installed as standard.
Wagner QuickClick Felt gliders available upon request.

Fabric usage: 1.4 meters based on 140cm roll.

Leather usage: 2.2 square meters based on a yield of 60% pr hide.

COM must be approved by &Tradition to ensure suitability for upholstery.

EU Ecolabel certified, validating high standards of durability, circular design, and responsible use of chemicals. Please contact our sales team for a list of EU Ecolabel compliant combinations.

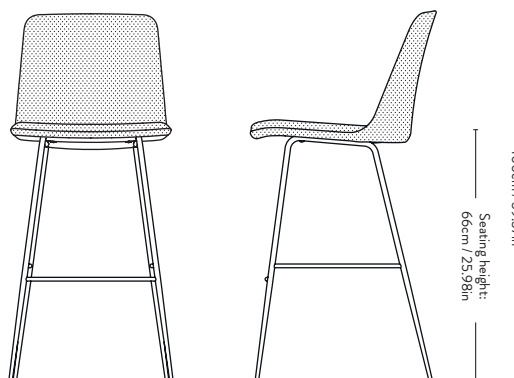

Rely ^{HW94} Hee Welling 2022



Price group	Upholstery	Model	Base	Lead time	Weight	PRICE EX. VAT (SEK)	PRICE INC. VAT (SEK)
Fabric gr. 1	Hot Madison, Remix, Re-Wool	HW94	Black, Bronzed	3-6 weeks	8.70 kg	5.368	6.710
Fabric gr. 2	Canvas, Barnum, Fiord, Ritz	HW94	Black, Bronzed	3-6 weeks	8.70 kg	6.084	7.605
Fabric gr. 3	Clay, Hallingdal, Steelcut Quartet, Steelcut Trio	HW94	Black, Bronzed	3-6 weeks	8.70 kg	6.204	7.755
Fabric gr. 4	Acca, Cifrado, Ecriture, Moss, Uniform Melange, Vidar	HW94	Black, Bronzed	3-6 weeks	8.70 kg	6.920	8.650
Fabric gr. 5	Karakorum, Sisu	HW94	Black, Bronzed	3-6 weeks	8.70 kg	8.352	10.440
Fabric gr. 6	Fuse, Gentle	HW94	Black, Bronzed	3-6 weeks	8.70 kg	9.188	11.485
Leather	Tailor Semi-aniline leather	HW94	Black, Bronzed	3-6 weeks	8.70 kg	7.276	9.095
Leather	Noble Aniline leather	HW94	Black, Bronzed	3-6 weeks	8.70 kg	7.636	9.545
Leather	Elmosoft Semi-aniline leather	HW94	Black, Bronzed	3-6 weeks	8.70 kg	8.712	10.890
Fabric COM	COM Fabric	HW94	Black, Bronzed	3-6 weeks	8.70 kg	5.368	6.710

Material: Shell made from 100% recycled polypropylene with fiber glass, covered with HR foam with fabric or leather upholstery, steel tube base.

Wagner QuickClick Plast gliders are installed as standard.
Wagner QuickClick Felt gliders available upon request.

Fabric usage: 1.8 meters based on a 140cm roll.

Leather usage: 2.7 square meters based on a yield of 60% pr hide.

COM must be approved by &Tradition to ensure suitability for upholstery.



EU Ecolabel certified, validating high standards of durability, circular design, and responsible use of chemicals. Please contact our sales team for a list of EU Ecolabel compliant combinations.

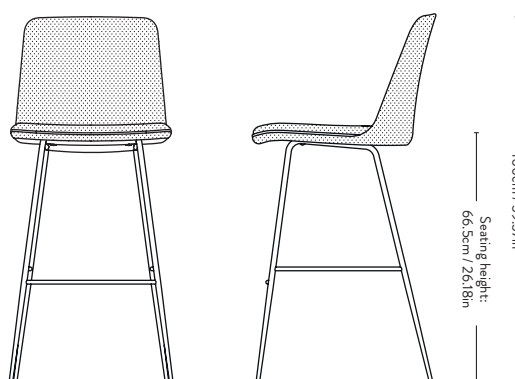

Rely ^{HW95} Hee Welling 2022



Please note that price is accumulated price of shell & seat.

Price group	Shell Upholstery	Base	Lead time	Weight	PRICE EX. VAT (SEK)	PRICE INC. VAT (SEK)
Fabric gr. 1	Hot Madison, Remix, Re-Wool	Black, Bronzed	3-6 weeks	10.50 kg	4.180	5.225
Fabric gr. 2	Canvas, Barnum, Fiord, Ritz	Black, Bronzed	3-6 weeks	10.50 kg	4.540	5.675
Fabric gr. 3	Clay, Hallingdal, Steelcut Quartet, Steelcut Trio	Black, Bronzed	3-6 weeks	10.50 kg	4.540	5.675
Fabric gr. 4	Acca, Cifrado, Ecriture, Moss, Uniform Melange, Vidar	Black, Bronzed	3-6 weeks	10.50 kg	4.892	6.115
Fabric gr. 5	Karakorum, Sisu	Black, Bronzed	3-6 weeks	10.50 kg	5.852	7.315
Fabric gr. 6	Fuse, Gentle	Black, Bronzed	3-6 weeks	10.50 kg	6.452	8.065
Leather	Tailor Semi-aniline leather	Black, Bronzed	3-6 weeks	10.50 kg	5.364	6.705
Leather	Noble Aniline leather	Black, Bronzed	3-6 weeks	10.50 kg	5.608	7.010
Leather	Elmosoft Semi-aniline leather	Black, Bronzed	3-6 weeks	10.50 kg	6.212	7.765
Fabric COM	COM Fabric	Black, Bronzed	3-6 weeks	10.50 kg	4.180	5.225

Price group	Seat Upholstery	Lead time	PRICE EX. VAT (SEK)	PRICE INC. VAT (SEK)
Fabric gr. 1	Hot Madison, Remix, Re-Wool	3-6 weeks	1.196	1.495
Fabric gr. 2	Canvas, Barnum, Fiord, Ritz	3-6 weeks	1.556	1.945
Fabric gr. 3	Clay, Hallingdal, Steelcut Quartet, Steelcut Trio	3-6 weeks	1.676	2.095
Fabric gr. 4	Acca, Cifrado, Ecriture, Moss, Uniform Melange, Vidar	3-6 weeks	2.032	2.540
Fabric gr. 5	Karakorum, Sisu	3-6 weeks	2.512	3.140
Fabric gr. 6	Fuse, Gentle	3-6 weeks	2.752	3.440
Leather	Tailor Semi-aniline leather	3-6 weeks	1.912	2.390
Leather	Noble Aniline leather	3-6 weeks	2.032	2.540
Leather	Elmosoft Semi-aniline leather	3-6 weeks	2.512	3.140
Fabric COM	COM Fabric	3-6 weeks	1.196	1.495

Material: Shell made from 100% recycled polypropylene with fiber glass, covered with HR foam with fabric or leather upholstery, steel tube base.

Wagner QuickClick Plast gliders are installed as standard.
Wagner QuickClick Felt gliders available upon request.

Fabric usage: 1.2 meters (shell), 0.7 meters (cushion) based on 140cm roll.
Leather usage: 2 square meters (shell), 0.9 square meters (cushion) based on a yield of 60% pr hide.

COM must be approved by &Tradition to ensure suitability for upholstery.

Minimum order quantity of same variant: 4 pcs.



EU Ecolabel certified, validating high standards of durability, circular design, and responsible use of chemicals. Please contact our sales team for a list of EU Ecolabel compliant combinations.



Rely ^{HW96} Hee Welling 2022



Item code	Shell Colour	Model	Base	Colli qty.	Lead time	Weight	PRICE EX. VAT (SEK)	PRICE INC. VAT (SEK)
HW	Black	HW96	Black, Bronzed	1 pc	2-3 weeks	7.40 kg	2.980	3.725
HW	White	HW96	Black, Bronzed	1 pc	2-3 weeks	7.40 kg	2.980	3.725
HW	Beige Sand	HW96	Black, Bronzed	1 pc	2-3 weeks	7.40 kg	2.980	3.725
HW	Red Brown	HW96	Black, Bronzed	1 pc	2-3 weeks	7.40 kg	2.980	3.725
HW	Light Blue	HW96	Black, Bronzed	1 pc	2-3 weeks	7.40 kg	2.980	3.725
HW	Stone Grey	HW96	Black, Bronzed	1 pc	2-3 weeks	7.40 kg	2.980	3.725

Material: Shell made from 100% recycled polypropylene with fiber glass and a steel tube base.

Wagner QuickClick Plast gliders are installed as standard.
Wagner QuickClick Felt gliders available upon request.



EU Ecolabel certified, validating high standards of durability, circular design, and responsible use of chemicals. Please contact our sales team for a list of EU Ecolabel compliant combinations.



49cm / 19.29in 54.4cm / 21.42in Seating depth: 45cm / 17.7in

22% RABATT SKA DRAS AV PÅ ANGIVNA PRISER

Rely^{HW97} Hee Welling 2022



Price group	Shell Colour	Seat Cushion Upholstery	Base	Lead time	Weight	PRICE EX. VAT (SEK)	PRICE INC. VAT (SEK)
Fabric gr. 1	Black, White, Beige Sand, Red Brown, Light Blue, Stone Grey	Hot Madison, Remix, Re-Wool	Black, Bronzed	3-6 weeks	8.20 kg	4.172	5.215
Fabric gr. 2	Black, White, Beige Sand, Red Brown, Light Blue, Stone Grey	Canvas, Barnum, Fiord, Ritz	Black, Bronzed	3-6 weeks	8.20 kg	4.532	5.665
Fabric gr. 3	Black, White, Beige Sand, Red Brown, Light Blue, Stone Grey	Clay, Hallingdal, Steelcut Quartet, Steelcut Black, Bronzed Trio	Black, Bronzed	3-6 weeks	8.20 kg	4.652	5.815
Fabric gr. 4	Black, White, Beige Sand, Red Brown, Light Blue, Stone Grey	Acca, Cifrado, Ecriture, Moss, Uniform Melange, Vidar	Black, Bronzed	3-6 weeks	8.20 kg	5.008	6.260
Fabric gr. 5	Black, White, Beige Sand, Red Brown, Light Blue, Stone Grey	Karakorum, Sisu	Black, Bronzed	3-6 weeks	8.20 kg	5.488	6.860
Fabric gr. 6	Black, White, Beige Sand, Red Brown, Light Blue, Stone Grey	Fuse, Gentle	Black, Bronzed	3-6 weeks	8.20 kg	6.084	7.605
Leather	Black, White, Beige Sand, Red Brown, Light Blue, Stone Grey	Tailor Semi-aniline leather	Black, Bronzed	3-6 weeks	8.20 kg	4.652	5.815
Leather	Black, White, Beige Sand, Red Brown, Light Blue, Stone Grey	Noble Aniline leather	Black, Bronzed	3-6 weeks	8.20 kg	5.008	6.260
Leather	Black, White, Beige Sand, Red Brown, Light Blue, Stone Grey	Elmosoft Semi-aniline leather	Black, Bronzed	3-6 weeks	8.20 kg	5.368	6.710
Fabric COM	Black, White, Beige Sand, Red Brown, Light Blue, Stone Grey	COM Fabric	Black, Bronzed	3-6 weeks	8.20 kg	4.172	5.215

Material: Shell made from 100% recycled polypropylene with fiber glass, HR foam seat covered with fabric or leather upholstery, steel tube base.

Wagner QuickClick Plast gliders are installed as standard.
Wagner QuickClick Felt gliders available upon request.

Fabric usage: 0.49 meter based on a 140 cm roll.

Leather usage: 1 square meter based on a yield of 60% pr hide.

COM must be approved by &Tradition to ensure suitability for upholstery.



EU Ecolabel certified, validating high standards of durability, circular design, and responsible use of chemicals. Please contact our sales team for a list of EU Ecolabel compliant combinations.



Rely^{HW98} Hee Welling 2022



Price group	Upholstery	Model	Base	Lead time	Weight	PRICE EX. VAT (SEK)	PRICE INC. VAT (SEK)
Fabric gr. 1	Hot Madison, Remix, Re-Wool	HW98	Black, Bronzed	3-6 weeks	7.90 kg	5.128	6.410
Fabric gr. 2	Canvas, Barnum, Fiord, Ritz	HW98	Black, Bronzed	3-6 weeks	7.90 kg	5.844	7.305
Fabric gr. 3	Clay, Hallingdal, Steelcut Quartet, Steelcut Trio	HW98	Black, Bronzed	3-6 weeks	7.90 kg	6.084	7.605
Fabric gr. 4	Acca, Cifrado, Ecriture, Moss, Uniform Melange, Vidar	HW98	Black, Bronzed	3-6 weeks	7.90 kg	6.680	8.350
Fabric gr. 5	Karakorum, Sisu	HW98	Black, Bronzed	3-6 weeks	7.90 kg	8.112	10.140
Fabric gr. 6	Fuse, Gentle	HW98	Black, Bronzed	3-6 weeks	7.90 kg	8.948	11.185
Leather	Tailor Semi-aniline leather	HW98	Black, Bronzed	3-6 weeks	7.90 kg	7.040	8.800
Leather	Noble Aniline leather	HW98	Black, Bronzed	3-6 weeks	7.90 kg	7.396	9.245
Leather	Elmosoft Semi-aniline leather	HW98	Black, Bronzed	3-6 weeks	7.90 kg	7.996	9.995
Fabric COM	COM Fabric	HW98	Black, Bronzed	3-6 weeks	7.90 kg	5.128	6.410

Material: Shell made from 100% recycled polypropylene with fiber glass, covered with HR foam with fabric or leather upholstery, steel tube base.

Wagner QuickClick Plast gliders are installed as standard.
Wagner QuickClick Felt gliders available upon request.

Fabric usage: 1.4 meters based on 140cm roll.

Leather usage: 2.2 square meters based on a yield of 60% pr hide.

COM must be approved by &Tradition to ensure suitability for upholstery.



EU Ecolabel certified, validating high standards of durability, circular design, and responsible use of chemicals. Please contact our sales team for a list of EU Ecolabel compliant combinations.

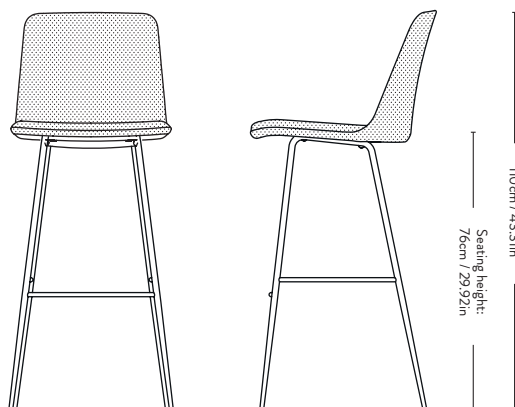

Rely ^{HW99} Hee Welling 2022



Price group	Upholstery	Model	Base	Lead time	Weight	PRICE EX. VAT (SEK)	PRICE INC. VAT (SEK)
Fabric gr. 1	Hot Madison, Remix, Re-Wool	HW99	Black, Bronzed	3-6 weeks	9.00 kg	5.368	6.710
Fabric gr. 2	Canvas, Barnum, Fiord, Ritz	HW99	Black, Bronzed	3-6 weeks	9.00 kg	6.084	7.605
Fabric gr. 3	Clay, Hallingdal, Steelcut Quartet, Steelcut Trio	HW99	Black, Bronzed	3-6 weeks	9.00 kg	6.324	7.905
Fabric gr. 4	Acca, Cifrado, Ecriture, Moss, Uniform Melange, Vidar	HW99	Black, Bronzed	3-6 weeks	9.00 kg	6.920	8.650
Fabric gr. 5	Karakorum, Sisu	HW99	Black, Bronzed	3-6 weeks	9.00 kg	8.352	10.440
Fabric gr. 6	Fuse, Gentle	HW99	Black, Bronzed	3-6 weeks	9.00 kg	9.188	11.485
Leather	Tailor Semi-aniline leather	HW99	Black, Bronzed	3-6 weeks	9.00 kg	7.276	9.095
Leather	Noble Aniline leather	HW99	Black, Bronzed	3-6 weeks	9.00 kg	7.636	9.545
Leather	Elmosoft Semi-aniline leather	HW99	Black, Bronzed	3-6 weeks	9.00 kg	8.712	10.890
Fabric COM	COM Fabric	HW99	Black, Bronzed	3-6 weeks	9.00 kg	5.368	6.710

Material: Shell made from 100% recycled polypropylene with fiber glass, covered with HR foam with fabric or leather upholstery, steel tube base.

Wagner QuickClick Plast gliders are installed as standard.
Wagner QuickClick Felt gliders available upon request.

Fabric usage: 1.8 meters based on a 140cm roll.

Leather usage: 2.7 square meters based on a yield of 60% pr hide.

COM must be approved by &Tradition to ensure suitability for upholstery.



EU Ecolabel certified, validating high standards of durability, circular design, and responsible use of chemicals. Please contact our sales team for a list of EU Ecolabel compliant combinations.

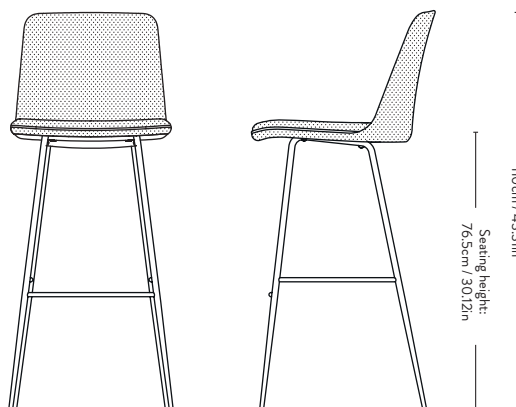

Rely ^{HW100} Hee Welling 2022



Please note that price is accumulated price of shell & seat.

Price group	Shell Upholstery	Base	Lead time	Weight	PRICE EX. VAT (SEK)	PRICE INC. VAT (SEK)
Fabric gr. 1	Hot Madison, Remix, Re-Wool	Black, Bronzed	3-6 weeks	9.00 kg	4.180	5.225
Fabric gr. 2	Canvas, Barnum, Fiord, Ritz	Black, Bronzed	3-6 weeks	9.00 kg	4.540	5.675
Fabric gr. 3	Clay, Hallingdal, Steelcut Quartet, Steelcut Trio	Black, Bronzed	3-6 weeks	9.00 kg	4.656	5.820
Fabric gr. 4	Acca, Cifrado, Ecriture, Moss, Uniform Melange, Vidar	Black, Bronzed	3-6 weeks	9.00 kg	4.892	6.115
Fabric gr. 5	Karakorum, Sisu	Black, Bronzed	3-6 weeks	9.00 kg	5.852	7.315
Fabric gr. 6	Fuse, Gentle	Black, Bronzed	3-6 weeks	9.00 kg	6.452	8.065
Leather	Tailor Semi-aniline leather	Black, Bronzed	3-6 weeks	9.00 kg	5.364	6.705
Leather	Noble Aniline leather	Black, Bronzed	3-6 weeks	9.00 kg	5.608	7.010
Leather	Elmosoft Semi-aniline leather	Black, Bronzed	3-6 weeks	9.00 kg	6.212	7.765
Fabric COM	COM Fabric	Black, Bronzed	3-6 weeks	9.00 kg	4.180	5.225

Price group	Seat Upholstery	Lead time	PRICE EX. VAT (SEK)	PRICE INC. VAT (SEK)
Fabric gr. 1	Hot Madison, Remix, Re-Wool	3-6 weeks	1.196	1.495
Fabric gr. 2	Canvas, Barnum, Fiord, Ritz	3-6 weeks	1.556	1.945
Fabric gr. 3	Clay, Hallingdal, Steelcut Quartet, Steelcut Trio	3-6 weeks	1.676	2.095
Fabric gr. 4	Acca, Cifrado, Ecriture, Moss, Uniform Melange, Vidar	3-6 weeks	2.032	2.540
Fabric gr. 5	Karakorum, Sisu	3-6 weeks	2.512	3.140
Fabric gr. 6	Fuse, Gentle	3-6 weeks	2.752	3.440
Leather	Tailor Semi-aniline leather	3-6 weeks	1.912	2.390
Leather	Noble Aniline leather	3-6 weeks	2.032	2.540
Leather	Elmosoft Semi-aniline leather	3-6 weeks	2.512	3.140
Fabric COM	COM Fabric	3-6 weeks	1.196	1.495

Material: Shell made from 100% recycled polypropylene with fiber glass, covered with HR foam with fabric or leather upholstery, steel tube base.

Wagner QuickClick Plast gliders are installed as standard.
Wagner QuickClick Felt gliders available upon request.

Fabric usage: 1.2 meters (shell), 0.7 meters (cushion) based on 140cm roll.
Leather usage: 2 square meters (shell), 0.9 square meters (cushion) based on a yield of 60% pr hide.

COM must be approved by &Tradition to ensure suitability for upholstery.

Minimum order quantity of same variant: 4 pcs.



EU Ecolabel certified, validating high standards of durability, circular design, and responsible use of chemicals. Please contact our sales team for a list of EU Ecolabel compliant combinations.



Rely ^{HW101} Hee Welling 2022



Item code	Shell Colour	Model	Base	Colli qty.	Lead time	Weight	PRICE EX. VAT (SEK)	PRICE INC. VAT (SEK)
HW	Black	HW101	Black	1 pc	2-3 weeks	6.40 kg	2.740	3.425
HW	White	HW101	Black	1 pc	2-3 weeks	6.40 kg	2.740	3.425
HW	Beige Sand	HW101	Black	1 pc	2-3 weeks	6.40 kg	2.740	3.425
HW	Red Brown	HW101	Black	1 pc	2-3 weeks	6.40 kg	2.740	3.425
HW	Light Blue	HW101	Black	1 pc	2-3 weeks	6.40 kg	2.740	3.425
HW	Stone Grey	HW101	Black	1 pc	2-3 weeks	6.40 kg	2.740	3.425

Material: Shell is made from 100% recycled polypropylene with fiber glass.

Wagner QuickClick Plast gliders are installed as standard.
Wagner QuickClick Felt gliders available upon request.



EU Ecolabel certified, validating high standards of durability, circular design, and responsible use of chemicals. Please contact our sales team for a list of EU Ecolabel compliant combinations.

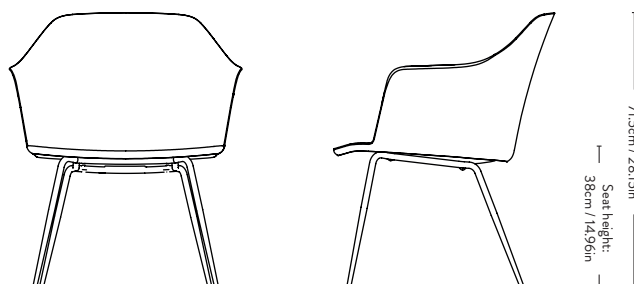

Rely ^{HW102} Hee Welling 2022



Price group	Shell Colour	Seat Cushion Upholstery	Base	Lead time	Weight	PRICE EX. VAT (SEK)	PRICE INC. VAT (SEK)
Fabric gr. 1	Black, White, Beige Sand, Red Brown, Light Blue, Stone Grey	Hot Madison, Remix, Re-Wool	Black	3-6 weeks	7.60 kg	3.936	4.920
Fabric gr. 2	Black, White, Beige Sand, Red Brown, Light Blue, Stone Grey	Canvas, Barnum, Fiord, Ritz	Black	3-6 weeks	7.60 kg	4.412	5.515
Fabric gr. 3	Black, White, Beige Sand, Red Brown, Light Blue, Stone Grey	Clay, Hallingdal, Steelcut Quartet, Steelcut Trio	Black	3-6 weeks	7.60 kg	4.652	5.815
Fabric gr. 4	Black, White, Beige Sand, Red Brown, Light Blue, Stone Grey	Acca, Cifrado, Ecriture, Moss, Uniform Melange, Vidar	Black	3-6 weeks	7.60 kg	4.888	6.110
Fabric gr. 5	Black, White, Beige Sand, Red Brown, Light Blue, Stone Grey	Karakorum, Sisu	Black	3-6 weeks	7.60 kg	5.368	6.710
Fabric gr. 6	Black, White, Beige Sand, Red Brown, Light Blue, Stone Grey	Fuse, Gentle	Black	3-6 weeks	7.60 kg	5.844	7.305
Leather	Black, White, Beige Sand, Red Brown, Light Blue, Stone Grey	Tailor Semi-aniline leather	Black	3-6 weeks	7.60 kg	4.532	5.665
Leather	Black, White, Beige Sand, Red Brown, Light Blue, Stone Grey	Noble Aniline leather	Black	3-6 weeks	7.60 kg	4.888	6.110
Leather	Black, White, Beige Sand, Red Brown, Light Blue, Stone Grey	Elmosoft Semi-aniline leather	Black	3-6 weeks	7.60 kg	5.248	6.560
Fabric COM	Black, White, Beige Sand, Red Brown, Light Blue, Stone Grey	COM Fabric	Black	3-6 weeks	7.60 kg	3.936	4.920

Material: Shell made from 100% recycled polypropylene with fiber glass, covered with HR foam with fabric or leather upholstery, steel tube base.

Wagner QuickClick Plast gliders are installed as standard.
Wagner QuickClick Felt gliders available upon request.

Fabric usage: 0.49 meters based on 140cm roll.

Leather usage: 1 square meter based on a yield of 60% pr hide.

COM must be approved by &Tradition to ensure suitability for upholstery.



EU Ecolabel certified, validating high standards of durability, circular design, and responsible use of chemicals. Please contact our sales team for a list of EU Ecolabel compliant combinations.

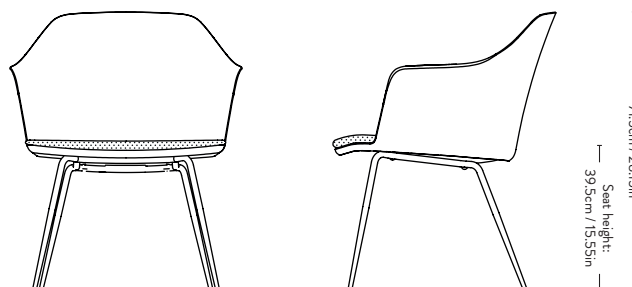

Rely^{HW103} Hee Welling 2022



Price group	Upholstery	Model	Base	Lead time	Weight	PRICE EX. VAT (SEK)	PRICE INC. VAT (SEK)
Fabric gr. 1	Hot Madison, Remix, Re-Wool	HW103	Black	3-6 weeks	7.10 kg	5.128	6.410
Fabric gr. 2	Canvas, Barnum, Fiord, Ritz	HW103	Black	3-6 weeks	7.10 kg	5.844	7.305
Fabric gr. 3	Clay, Hallingdal, Steelcut Quartet, Steelcut Trio	HW103	Black	3-6 weeks	7.10 kg	6.084	7.605
Fabric gr. 4	Acca, Cifrado, Ecriture, Moss, Uniform Melange, Vidar	HW103	Black	3-6 weeks	7.10 kg	6.800	8.500
Fabric gr. 5	Karakorum, Sisu	HW103	Black	3-6 weeks	7.10 kg	9.068	11.335
Fabric gr. 6	Fuse, Gentle	HW103	Black	3-6 weeks	7.10 kg	10.024	12.530
Leather	Tailor Semi-aniline leather	HW103	Black	3-6 weeks	7.10 kg	7.160	8.950
Leather	Noble Aniline leather	HW103	Black	3-6 weeks	7.10 kg	8.592	10.740
Leather	Elmosoft Semi-aniline leather	HW103	Black	3-6 weeks	7.10 kg	9.428	11.785
Fabric COM	COM Fabric	HW103	Black	3-6 weeks	7.10 kg	5.128	6.410

Material: Shell made from 100% recycled polypropylene with fiber glass, covered with HR foam with fabric or leather upholstery, steel tube base.

Wagner QuickClick Plast gliders are installed as standard.
Wagner QuickClick Felt gliders available upon request.

Fabric usage: 1.5 meters based on 140cm roll.

Leather usage: 2.7 square meters based on a yield of 60% pr hide.

COM must be approved by &Tradition to ensure suitability for upholstery.



EU Ecolabel certified, validating high standards of durability, circular design, and responsible use of chemicals. Please contact our sales team for a list of EU Ecolabel compliant combinations.

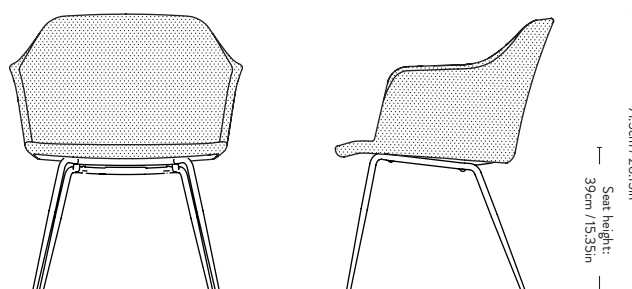

Rely^{HW104} Hee Welling 2022



Price group	Upholstery	Model	Base	Lead time	Weight	PRICE EX. VAT (SEK)	PRICE INC. VAT (SEK)
Fabric gr. 1	Hot Madison, Remix, Re-Wool	HW104	Black	3-6 weeks	7.40 kg	5.488	6.860
Fabric gr. 2	Canvas, Barnum, Fiord, Ritz	HW104	Black	3-6 weeks	7.40 kg	6.204	7.755
Fabric gr. 3	Clay, Hallingdal, Steelcut Quartet, Steelcut Trio	HW104	Black	3-6 weeks	7.40 kg	6.440	8.050
Fabric gr. 4	Acca, Cifrado, Ecriture, Moss, Uniform Melange, Vidar	HW104	Black	3-6 weeks	7.40 kg	7.160	8.950
Fabric gr. 5	Karakorum, Sisu	HW104	Black	3-6 weeks	7.40 kg	9.428	11.785
Fabric gr. 6	Fuse, Gentle	HW104	Black	3-6 weeks	7.40 kg	10.384	12.980
Leather	Tailor Semi-aniline leather	HW104	Black	3-6 weeks	7.40 kg	7.516	9.395
Leather	Noble Aniline leather	HW104	Black	3-6 weeks	7.40 kg	8.948	11.185
Leather	Elmosoft Semi-aniline leather	HW104	Black	3-6 weeks	7.40 kg	10.024	12.530
Fabric COM	COM Fabric	HW104	Black	3-6 weeks	7.40 kg	5.488	6.860

Material: Shell made from 100% recycled polypropylene with fiber glass, covered with HR foam with fabric or leather upholstery, steel tube base.

Wagner QuickClick Plast gliders are installed as standard.
Wagner QuickClick Felt gliders available upon request.

Fabric usage: 2.3 meters based on 140cm roll.

Leather usage: 3.4 square meters based on a yield of 60% pr hide.

COM must be approved by &Tradition to ensure suitability for upholstery.



EU Ecolabel certified, validating high standards of durability, circular design, and responsible use of chemicals. Please contact our sales team for a list of EU Ecolabel compliant combinations.

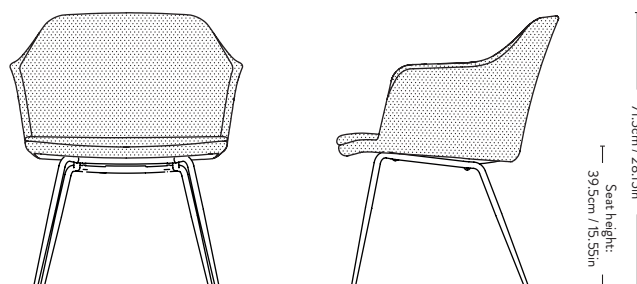

Rely^{HW105} Hee Welling 2022



Please note that price is accumulated price of shell & seat.

Price group	Shell Upholstery	Model	Base	Lead time	Weight	PRICE EX. VAT (SEK)	PRICE INC. VAT (SEK)
Fabric gr. 1	Hot Madison, Remix, Re-Wool	HW105	Black	3-6 weeks	7.40 kg	4.300	5.375
Fabric gr. 2	Canvas, Barnum, Fiord, Ritz	HW105	Black	3-6 weeks	7.40 kg	4.656	5.820
Fabric gr. 3	Clay, Hallingdal, Steelcut Quartet, Steelcut Trio	HW105	Black	3-6 weeks	7.40 kg	4.768	5.960
Fabric gr. 4	Acca, Cifrado, Ecriture, Moss, Uniform Melange, Vidar	HW105	Black	3-6 weeks	7.40 kg	5.132	6.415
Fabric gr. 5	Karakorum, Sisu	HW105	Black	3-6 weeks	7.40 kg	6.928	8.660
Fabric gr. 6	Fuse, Gentle	HW105	Black	3-6 weeks	7.40 kg	7.648	9.560
Leather	Tailor Semi-aniline leather	HW105	Black	3-6 weeks	7.40 kg	5.616	7.020
Leather	Noble Aniline leather	HW105	Black	3-6 weeks	7.40 kg	6.928	8.660
Leather	Elmosoft Semi-aniline leather	HW105	Black	3-6 weeks	7.40 kg	7.528	9.410
Fabric COM	COM Fabric	HW105	Black	3-6 weeks	7.40 kg	4.300	5.375

Price group	Seat Upholstery	Lead time	PRICE EX. VAT (SEK)	PRICE INC. VAT (SEK)
Fabric gr. 1	Hot Madison, Remix, Re-Wool	3-6 weeks	1.196	1.495
Fabric gr. 2	Canvas, Barnum, Fiord, Ritz	3-6 weeks	1.556	1.945
Fabric gr. 3	Clay, Hallingdal, Steelcut Quartet, Steelcut Trio	3-6 weeks	1.676	2.095
Fabric gr. 4	Acca, Cifrado, Ecriture, Moss, Uniform Melange, Vidar	3-6 weeks	2.032	2.540
Fabric gr. 5	Karakorum, Sisu	3-6 weeks	2.512	3.140
Fabric gr. 6	Fuse, Gentle	3-6 weeks	2.752	3.440
Leather	Tailor Semi-aniline leather	3-6 weeks	1.912	2.390
Leather	Noble Aniline leather	3-6 weeks	2.032	2.540
Leather	Elmosoft Semi-aniline leather	3-6 weeks	2.512	3.140
Fabric COM	COM Fabric	3-6 weeks	1.196	1.495

Material: Shell made from 100% recycled polypropylene with fiber glass, covered with HR foam with fabric or leather upholstery, steel tube base.

Wagner QuickClick Plast gliders are installed as standard.
Wagner QuickClick Felt gliders available upon request.

Fabric usage: 1.5 meters (shell), 0.8 meters (cushion) based on 140cm roll.
Leather usage: 2.7 square meters (shell), 0.8 square meters (cushion) based on a yield of 60% pr hide.

COM must be approved by &Tradition to ensure suitability for upholstery.

Minimum order quantity of same variant: 4 pcs.



EU Ecolabel certified, validating high standards of durability, circular design, and responsible use of chemicals. Please contact our sales team for a list of EU Ecolabel compliant combinations.

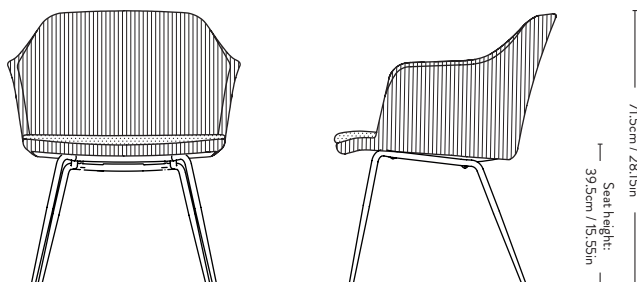

Rely Seat Pad Hee Welling 2020



Price group	Upholstery	Lead time	Weight	PRICE EX. VAT (SEK)	PRICE INC. VAT (SEK)
Fabric gr. 1	Hot Madison, Remix, Re-Wool	3-6 weeks	0.30 kg	888	1.110
Fabric gr. 2	Canvas, Barnum, Fiord, Ritz	3-6 weeks	0.30 kg	1.068	1.335
Fabric gr. 3	Clay, Hallingdal, Steelcut Quartet, Steelcut Trio	3-6 weeks	0.30 kg	1.188	1.485
Fabric gr. 4	Acca, Cifrado, Ecriture, Moss, Uniform Melange, Vidar	3-6 weeks	0.30 kg	1.428	1.785
Fabric gr. 5	Karakorum, Sisu	3-6 weeks	0.30 kg	2.264	2.830
Fabric gr. 6	Fuse, Gentle	3-6 weeks	0.30 kg	2.500	3.125
Leather	Tailor Semi-aniline leather	3-6 weeks	0.30 kg	1.068	1.335
Leather	Noble Aniline leather	3-6 weeks	0.30 kg	1.308	1.635
Leather	Elmosoft Semi-aniline leather	3-6 weeks	0.30 kg	1.428	1.785
Fabric COM	COM Fabric	3-6 weeks	0.30 kg	888	1.110

Material: HR foam with anti-slip backing with textile or leather upholstery.

Fabric usage: 0.5 meter based on a 140 cm roll.

Leather usage: 1 square meters based on a yield of 60% pr hide.

Suitable for all Rely plastic sidechairs

COM must be approved by &Tradition to ensure suitability for upholstery.

Minimum order quantity of same variant: 4 pcs.

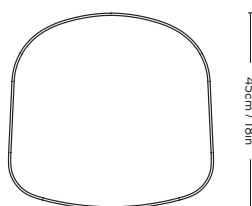

Rely Armchair Seat Pad

Hee Welling

2021



Price group	Upholstery	Lead time	Weight	PRICE EX. VAT (SEK)	PRICE INC. VAT (SEK)
Fabric gr. 1	Hot Madison, Remix, Re-Wool	3-6 weeks	0.30 kg	888	1.110
Fabric gr. 2	Canvas, Barnum, Fiord, Ritz	3-6 weeks	0.30 kg	1.068	1.335
Fabric gr. 3	Clay, Hallingdal, Steelcut Quartet, Steelcut Trio	3-6 weeks	0.30 kg	1.188	1.485
Fabric gr. 4	Acca, Cifrado, Ecriture, Moss, Uniform Melange, Vidar	3-6 weeks	0.30 kg	1.428	1.785
Fabric gr. 5	Karakorum, Sisu	3-6 weeks	0.30 kg	2.264	2.830
Fabric gr. 6	Fuse, Gentle	3-6 weeks	0.30 kg	2.500	3.125
Leather	Tailor Semi-aniline leather	3-6 weeks	0.30 kg	1.068	1.335
Leather	Noble Aniline leather	3-6 weeks	0.30 kg	1.308	1.635
Leather	Elmosoft Semi-aniline leather	3-6 weeks	0.30 kg	1.428	1.785
Fabric COM	COM Fabric	3-6 weeks	0.30 kg	888	1.110

Material: HR foam with anti-slip backing with textile or leather upholstery.

Fabric usage: 0.5 meter based on a 140 cm roll.

Leather usage: 1 square meters based on a yield of 60% pr hide.

Suitable for all Rely plastic armchairs

COM must be approved by &Tradition to ensure suitability for upholstery.

Minimum order quantity of same variant: 4 pcs.

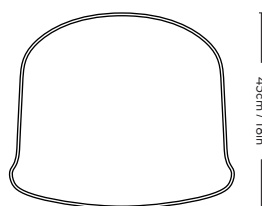

Rely Stool Seat Pad

Hee Welling

2021



Price group	Upholstery	Lead time	Weight	PRICE EX. VAT (SEK)	PRICE INC. VAT (SEK)
Fabric gr. 1	Hot Madison, Remix, Re-Wool	3-6 weeks	0.30 kg	888	1.110
Fabric gr. 2	Canvas, Barnum, Fiord, Ritz	3-6 weeks	0.30 kg	1.068	1.335
Fabric gr. 3	Clay, Hallingdal, Steelcut Quartet, Steelcut Trio	3-6 weeks	0.30 kg	1.188	1.485
Fabric gr. 4	Acca, Cifrado, Ecriture, Moss, Uniform Melange, Vidar	3-6 weeks	0.30 kg	1.428	1.785
Fabric gr. 5	Karakorum, Sisu	3-6 weeks	0.30 kg	2.264	2.830
Fabric gr. 6	Fuse, Gentle	3-6 weeks	0.30 kg	2.500	3.125
Leather	Tailor Semi-aniline leather	3-6 weeks	0.30 kg	1.068	1.335
Leather	Noble Aniline leather	3-6 weeks	0.30 kg	1.308	1.635
Leather	Elmosoft Semi-aniline leather	3-6 weeks	0.30 kg	1.428	1.785
Fabric COM	COM Fabric	3-6 weeks	0.30 kg	888	1.110

Material: HR foam with anti-slip backing with textile or leather upholstery.

Fabric usage: 0.5 meter based on a 140 cm roll.

Leather usage: 1 square meters based on a yield of 60% pr hide.

Suitable for all Rely plastic stool

COM must be approved by &Tradition to ensure suitability for upholstery.

Minimum order quantity of same variant: 4 pcs.

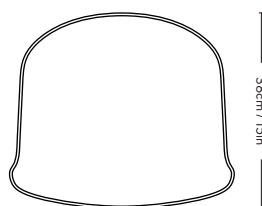

Betty^{TK1 & TK2} Thau & Kallio 2019



Item code	Product	Webbing	Model	Colli qty.	Lead time	Weight	PRICE EX. VAT (SEK)	PRICE INC. VAT (SEK)
13010094	Black	Natural	TK1	2 pcs	Stock item	4.00 kg	4.412	5.515
13010092	Oak	Natural	TK1	2 pcs	Stock item	4.00 kg	4.412	5.515
13010093	Smoked oak NEW	Natural	TK1	2 pcs	Stock item	4.00 kg	4.412	5.515
13011094	Black	Black	TK1	2 pcs	Stock item	4.00 kg	4.412	5.515
13020094	Black		TK2	2 pcs	Stock item	4.70 kg	3.576	4.470
13020092	Oak		TK2	2 pcs	Stock item	4.70 kg	3.576	4.470
13020093	Smoked oak NEW		TK2	2 pcs	Stock item	4.70 kg	3.576	4.470
13010000	Betty linking system *must be specified with the order			1 pc	6-8 weeks	0.40 kg	712	890

Frame **Seat**

TK1 Wood Natural or Black Linen and PP webbing
TK2 Wood Wood

Material: Water based lacquered or oiled solid wood and formpressed veneer with seat in natural or black linen and PP webbing or form pressed veneer.

TK1, TK2 Black water based lacquered ash.
 TK1, TK2 Water based lacquered oak and Smoked oiled oak.

Wagner QuickClick Plast gliders are installed as standard.
 Wagner QuickClick Felt gliders available upon request.

Stackable chair: 8 pcs



TK2: EU Ecolabel certified, validating high standards of durability, circular design, and responsible use of chemicals. Please contact our sales team for a list of EU Ecolabel compliant combinations.

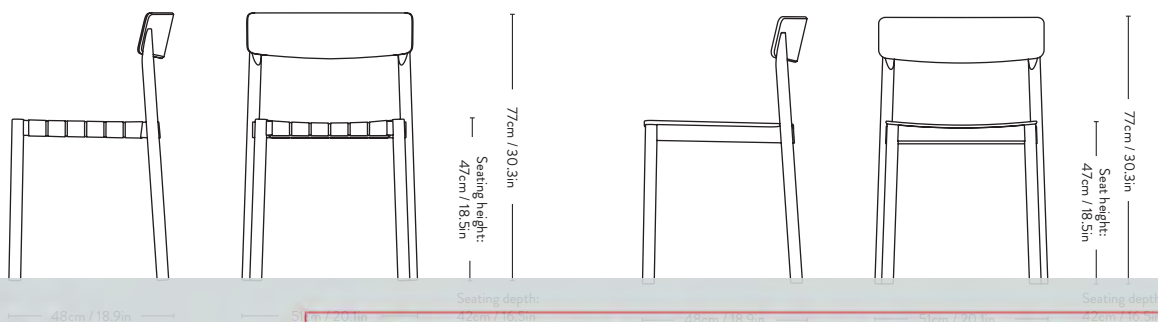

Betty^{TK3} Thau & Kallio 2019



Item code	Product	Model	Frame	Colli qty.	Lead time	Weight	PRICE EX. VAT (SEK)	PRICE INC. VAT (SEK)
13039520	Noble Aniline leather Black	TK3	Black	2 pcs	Stock item	5.60 kg	5.368	6.710
13039525	Noble Aniline leather Cognac	TK3	Oak	2 pcs	Stock item	5.60 kg	5.368	6.710
13039521	Noble Aniline leather Black	TK3	Smoked Oak NEW	2 pcs	Stock item	5.60 kg	5.368	6.710

Price group	Upholstery	Model	Frame	Lead time	Weight	PRICE EX. VAT (SEK)	PRICE INC. VAT (SEK)
Fabric gr. 1	Hot Madison, Remix, Re-Wool	TK3	Black, Oak,	6-8 weeks	5.60 kg	4.772	5.965
		TK3	Smoked Oak NEW	6-8 weeks	5.60 kg		
Fabric gr. 2	Canvas, Barnum, Fiord, Ritz	TK3	Black, Oak,	6-8 weeks	5.60 kg	5.008	6.260
		TK3	Smoked Oak NEW	6-8 weeks	5.60 kg		
Fabric gr. 3	Clay, Hallingdal, Steelcut Quartet, Steelcut Trio	TK3	Black, Oak,	6-8 weeks	5.60 kg	5.128	6.410
		TK3	Smoked Oak NEW	6-8 weeks	5.60 kg		
Fabric gr. 4	Acca, Cifrado, Ecriture, Moss, Uniform Melange, Vidar	TK3	Black, Oak,	6-8 weeks	5.60 kg	5.248	6.560
		TK3	Smoked Oak NEW	6-8 weeks	5.60 kg		
Fabric gr. 5	Karakorum, Sisu	TK3	Black, Oak,	6-8 weeks	5.60 kg	5.604	7.005
		TK3	Smoked Oak NEW	6-8 weeks	5.60 kg		
Fabric gr. 6	Fuse, Gentle	TK3	Black, Oak,	6-8 weeks	5.60 kg	6.204	7.755
		TK3	Smoked Oak NEW	6-8 weeks	5.60 kg		
Leather	Tailor Semi-aniline leather	TK3	Black, Oak,	6-8 weeks	5.60 kg	4.888	6.110
		TK3	Smoked Oak NEW	6-8 weeks	5.60 kg		
Leather	Noble Aniline leather	TK3	Black, Oak,	6-8 weeks	5.60 kg	5.368	6.710
		TK3	Smoked Oak NEW	6-8 weeks	5.60 kg		
Leather	Elmosoft Semi-aniline leather	TK3	Black, Oak,	6-8 weeks	5.60 kg	5.724	7.155
		TK3	Smoked Oak NEW	6-8 weeks	5.60 kg		
Fabric COM	COM Fabric	TK3	Black, Oak,	6-8 weeks	5.60 kg	4.772	5.965
		TK3	Smoked Oak NEW	6-8 weeks	5.60 kg		
13010000	Betty linking system *must be specified with the order			6-8 weeks	0.40 kg	712	890

Frame Seat

TK3 Wood Upholstered

Material: Water based lacquered or oiled solid wood and formpressed veneer with upholstered HR foam seat.

TK3 Black water based lacquered ash.

TK3 Water based lacquered oak and Smoked oiled oak.

Fabric usage: 0.36 meter based on a 140 cm roll.

Leather usage: 0.36 square meters based on a yield of 60% pr hide.

COM must be approved by Tradition to ensure suitability for upholstery.

Wagner QuickClick Plast gliders are installed as standard.

Wagner QuickClick Felt gliders available upon request.



EU Ecolabel certified, validating high standards of durability, circular design, and responsible use of chemicals. Please contact our sales team for a list of EU Ecolabel compliant combinations.

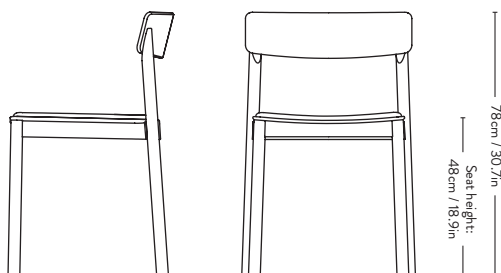

NEW

Betty^{TK9 & TK10} Thau & Kallio 2024

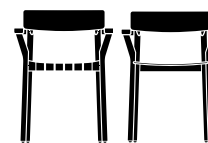

Item code	Product	Webbing	Model	Colli qty.	Lead time	Weight	PRICE EX. VAT (SEK)	PRICE INC. VAT (SEK)
13090001	Oak	Natural	TK9	2 pcs	Stock item	5.00 kg	6.560	8.200
13090002	Black	Natural	TK9	2 pcs	Stock item	5.00 kg	6.560	8.200
13090003	Smoked Oak	Natural	TK9	2 pcs	Stock item	5.00 kg	6.560	8.200
13090004	Black	Black	TK9	2 pcs	Stock item	5.00 kg	6.560	8.200
13100001	Oak		TK10	2 pcs	Stock item	5.00 kg	5.724	7.155
13100002	Black		TK10	2 pcs	Stock item	5.00 kg	5.724	7.155
13100003	Smoked Oak		TK10	2 pcs	Stock item	5.00 kg	5.724	7.155

Frame **Seat**

TK9 Wood Natural or Black Linen and PP webbing
TK10 Wood Wood

Material: Water based lacquered or oiled solid wood and formpressed veneer with seat in natural or black linen and PP webbing or form pressed veneer.

TK9, TK10 Black water based lacquered ash.
 TK9, TK10 Water based lacquered oak and Smoked oiled oak.

Wagner QuickClick Plast gliders are installed as standard.
 Wagner QuickClick Felt gliders available upon request.

Stackable chair: 8 pcs

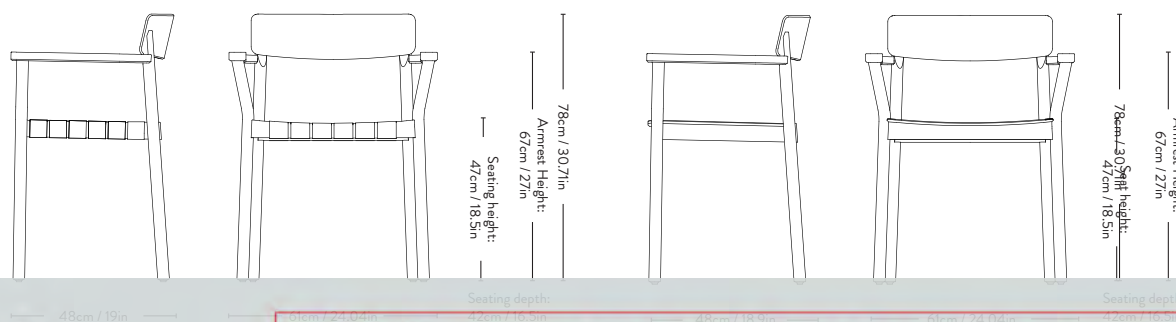

NEW

Betty^{TK11} Thau & Kallio 2024



Item code	Product	Model	Frame	Colli qty.	Lead time	Weight	PRICE EX. VAT (SEK)	PRICE INC. VAT (SEK)
13110016	Noble Aniline leather Cognac	TK11	Oak	2 pcs	Stock item	5.60 kg	7.516	9.395
13110017	Noble Aniline leather Black	TK11	Black	2 pcs	Stock item	5.60 kg	7.516	9.395
13110033	Noble Aniline leather Black	TK11	Smoked oak	2 pcs	Stock item	5.60 kg	7.516	9.395

Price group	Upholstery	Model	Frame	Lead time	Weight	PRICE EX. VAT (SEK)	PRICE INC. VAT (SEK)
Fabric gr. 1	Hot Madison, Remix, Re-Wool	TK11	Black, Oak, Smoked oak	6-8 weeks	5.60 kg	6.920	8.650
Fabric gr. 2	Canvas, Barnum, Fiord, Ritz	TK11	Black, Oak, Smoked oak	6-8 weeks	5.60 kg	7.160	8.950
Fabric gr. 3	Clay, Hallingdal, Steelcut Quartet, Steelcut Trio	TK11	Black, Oak, Smoked oak	6-8 weeks	5.60 kg	7.276	9.095
Fabric gr. 4	Acca, Cifrado, Ecriture, Moss, Uniform Melange, Vidar	TK11	Black, Oak, Smoked oak	6-8 weeks	5.60 kg	7.396	9.245
Fabric gr. 5	Karakorum, Sisu	TK11	Black, Oak, Smoked oak	6-8 weeks	5.60 kg	7.756	9.695
Fabric gr. 6	Fuse, Gentle	TK11	Black, Oak, Smoked oak	6-8 weeks	5.60 kg	8.352	10.440
Leather	Tailor Semi-aniline leather	TK11	Black, Oak, Smoked oak	6-8 weeks	5.60 kg	7.040	8.800
Leather	Noble Aniline leather	TK11	Black, Oak, Smoked oak	6-8 weeks	5.60 kg	7.516	9.395
Leather	Elmosoft Semi-aniline leather	TK11	Black, Oak, Smoked oak	6-8 weeks	5.60 kg	7.876	9.845
Fabric COM	COM Fabric	TK11	Black, Oak, Smoked oak	6-8 weeks	5.60 kg	6.920	8.650

Frame Seat

TK11 Wood Upholstered

Material: Water based lacquered or oiled solid wood and formpressed veneer with upholstered HR foam seat.

TK11 Black water based lacquered ash.
TK11 Water based lacquered oak and Smoked oiled oak.

Fabric usage: 0.36 meter based on a 140 cm roll.
Leather usage: 0.36 square meters based on a yield of 60% pr hide.

COM must be approved by Tradition to ensure suitability for upholstery.

Wagner QuickClick Plast gliders are installed as standard.
Wagner QuickClick Felt gliders available upon request.

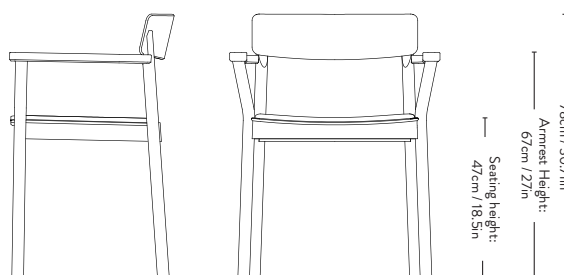

Betty^{TK4 & TK5} Thau & Kallio 2019



Item code	Product	Webbing	Model	Colli qty.	Lead time	Weight	PRICE EX. VAT (SEK)	PRICE INC. VAT (SEK)
13040094	Black	Natural	TK4	1 pc	Stock item	5.80 kg	6.560	8.200
13041094	Black	Black	TK4	1 pc	Stock item	5.80 kg	6.560	8.200
13040092	Oak	Natural	TK4	1 pc	Stock item	5.80 kg	6.560	8.200
13040093	Smoked Oak NEW	Natural	TK4	1 pc	Stock item	5.80 kg	6.560	8.200
13050094	Black	Natural	TK5	1 pc	Stock item	7.40 kg	7.756	9.695
13051094	Black	Black	TK5	1 pc	Stock item	7.40 kg	7.756	9.695
13050092	Oak	Natural	TK5	1 pc	Stock item	7.40 kg	7.756	9.695
13050093	Smoked oak NEW	Natural	TK5	1 pc	Stock item	7.40 kg	7.756	9.695

Frame Seat

TK4 Wood Natural or Black Linen and PP webbing
TK5 Wood Natural or Black Linen and PP webbing

Material: Water based lacquered or oiled solid wood and formpressed veneer with seat in natural linen and PP webbing.

TK4, TK5 Black water based lacquered ash.
 TK4, TK5 Water based lacquered oak and Smoked oiled oak.

Felt gliders installed as standard.

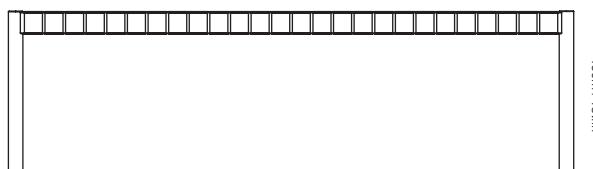
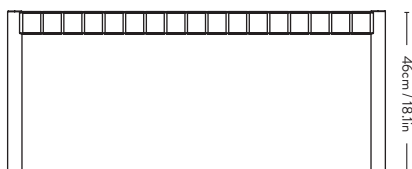
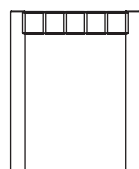

Betty^{TK7 & TK8} Thau & Kallio 2021



Item code	Product	Webbing	Model	Colli qty.	Lead time	Weight	PRICE EX. VAT (SEK)	PRICE INC. VAT (SEK)
13070094	Black	Natural	TK7	1 pc	Stock item	3.50 kg	4.532	5.665
13071094	Black	Black	TK7	1 pc	Stock item	3.50 kg	4.532	5.665
13070092	Oak	Natural	TK7	1 pc	Stock item	3.50 kg	4.532	5.665
13070093	Smoked oak NEW	Natural	TK7	1 pc	Stock item	3.50 kg	4.532	5.665
13071199	TK7 w. Footrest Protector*		TK7	1 pc	6-8 weeks	3.60 kg	4.884	6.105
13080094	Black	Natural	TK8	1 pc	Stock item	3.50 kg	4.532	5.665
13081094	Black	Black	TK8	1 pc	Stock item	3.50 kg	4.532	5.665
13080092	Oak	Natural	TK8	1 pc	Stock item	3.50 kg	4.532	5.665
13080093	Smoked oak NEW	Natural	TK8	1 pc	Stock item	3.50 kg	4.532	5.665
13081199	TK8 w. Footrest Protector*		TK8	1 pc	6-8 weeks	3.60 kg	4.884	6.105
13010005	Footrest protector			1 pc	Stock item	0.10 kg	352	440

Frame Seat

TK7 Wood Natural or Black Linen and PP webbing
TK8 Wood Natural or Black Linen and PP webbing

Material: Water based lacquered or oiled solid wood with seat in natural linen and PP webbing.
 The footrest protector is from steel.

TK7, TK8 Water based Black lacquered ash.
 TK7, TK8 Water based lacquered oak and Smoked oiled oak.

Felt gliders installed as standard.
 Plastic gliders are available upon request

*Please specify stool colour with the order
 (Black, Black/Black, Oak, Smoked Oak).

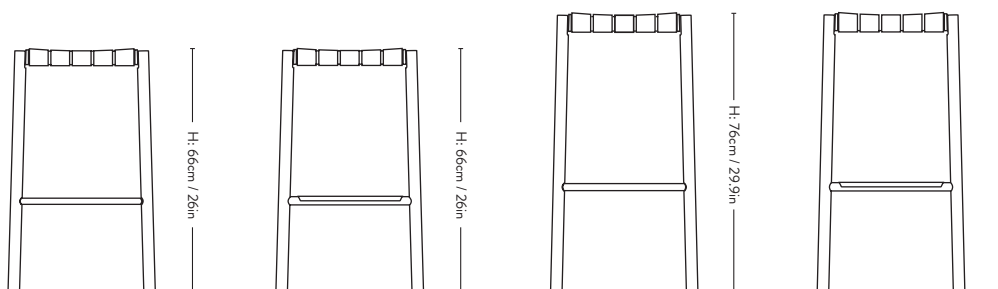

NEW

Allwood AV35 Anderssen & Voll 2024



Item code	Product	Model	Finish	Colli qty.	Lead time	Weight	PRICE EX. VAT (SEK)	PRICE INC. VAT (SEK)
91101002	Allwood Chair	AV35	Oak	2 pcs	Stock item	4.80 kg	5.144	6.430
91101008	Allwood Stacking trolley	AV35	Oak	1 pc	Stock item	9.30 kg	5.964	7.455

Material: Water based lacquered Solid oak & oak veneer

Stacking quantity: 12 pcs

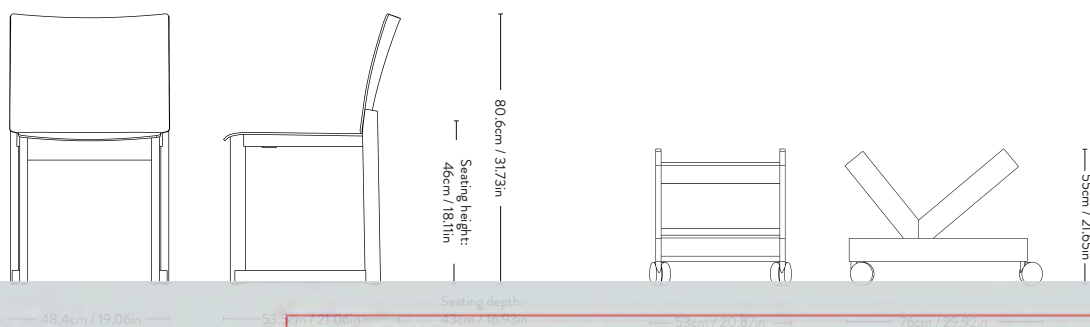

Boomerang^{HM1} Hvidt & Mølgaard 1956



Item no.	Upholstery	Base	Finish	Model	Lead time	Weight	PRICE EX. VAT (SEK)	PRICE INC. VAT (SEK)
14019205	Karakorum 003	Brass	Oiled Oak	HM1	Stock item	8.50 kg	26.264	32.830
14019605		Brass	Oiled Walnut				28.652	35.815
14019405		Stainless Steel	Oiled Oak				26.264	32.830
14019705		Stainless Steel	Oiled Walnut				28.652	35.815

	Upholstery	Base	Finish	Model	Lead time	Weight	PRICE EX. VAT (SEK)	PRICE INC. VAT (SEK)
Fabric gr. 1	Hot Madison, Remix, Re-Wool	Brass	Oiled Oak	HM1	6-8 weeks	8.50 kg	26.264	32.830
		Brass	Oiled Walnut				28.652	35.815
		Stainless Steel	Oiled Oak				26.264	32.830
		Stainless Steel	Oiled Walnut				28.652	35.815
Fabric gr. 2	Canvas, Barnum, Fiord, Ritz	Brass	Oiled Oak	HM1	6-8 weeks	8.50 kg	27.456	34.320
		Brass	Oiled Walnut				29.844	37.305
		Stainless Steel	Oiled Oak				27.456	34.320
		Stainless Steel	Oiled Walnut				29.844	37.305
Fabric gr. 3	Clay, Hallingdal, Steelcut Quartet, Steelcut Trio	Brass	Oiled Oak	HM1	6-8 weeks	8.50 kg	28.052	35.065
		Brass	Oiled Walnut				30.440	38.050
		Stainless Steel	Oiled Oak				28.052	35.065
		Stainless Steel	Oiled Walnut				30.440	38.050
Fabric gr. 4	Acca, Cifrado, Ecriture, Moss, Uniform Melange, Vidar	Brass	Oiled Oak	HM1	6-8 weeks	8.50 kg	28.652	35.815
		Brass	Oiled Walnut				31.040	38.800
		Stainless Steel	Oiled Oak				28.652	35.815
		Stainless Steel	Oiled Walnut				31.040	38.800
Fabric gr. 5	Karakorum, Sisu	Brass	Oiled Oak	HM1	6-8 weeks	8.50 kg	29.844	37.305
		Brass	Oiled Walnut				32.232	40.290
		Stainless Steel	Oiled Oak				29.844	37.305
		Stainless Steel	Oiled Walnut				32.232	40.290
Fabric gr. 6	Fuse, Gentle	Brass	Oiled Oak	HM1	6-8 weeks	8.50 kg	33.428	41.785
		Brass	Oiled Walnut				35.816	44.770
		Stainless Steel	Oiled Oak				33.428	41.785
		Stainless Steel	Oiled Walnut				35.816	44.770
Fabric COM	COM Fabric	Brass	Oiled Oak	HM1	6-8 weeks	8.50 kg	26.264	32.830
		Brass	Oiled Walnut				28.652	35.815
		Stainless Steel	Oiled Oak				26.264	32.830
		Stainless Steel	Oiled Walnut				28.652	35.815

Frame	Finish
Wood	Oiled Oak, Oiled Walnut
Metal	Brass, Stainless Steel

Material: Wood, HR foam, polyester wadding, fabric upholstery, brass, and stainless steel.

Fabric usage: 2 meters based on a 140cm roll.

COM must be approved by &Tradition to ensure suitability for upholstery.

HM1 is not available in leather.

Plastic gliders are installed as standard.

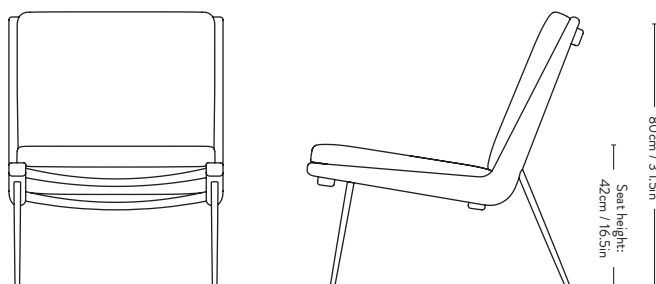

Boomerang^{HM2} Hvidt & Mølgaard 1956

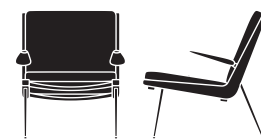

Item no.	Upholstery	Base	Finish	Model	Lead time	Weight	PRICE EX. VAT (SEK)	PRICE INC. VAT (SEK)
14029205	Karakorum 003	Brass	Oiled Oak	HM2	Stock item	8.50 kg	28.652	35.815
14029605		Brass	Oiled Walnut				32.236	40.295
14029405		Stainless Steel	Oiled Oak				28.652	35.815
14029705		Stainless Steel	Oiled Walnut				32.236	40.295

	Upholstery	Base	Finish	Model	Lead time	Weight	PRICE EX. VAT (SEK)	PRICE INC. VAT (SEK)
Fabric gr. 1	Hot Madison, Remix, Re-Wool	Brass	Oiled Oak	HM2	6-8 weeks	8.50 kg	28.652	35.815
		Brass	Oiled Walnut				32.236	40.295
		Stainless Steel	Oiled Oak				28.652	35.815
		Stainless Steel	Oiled Walnut				32.236	40.295
Fabric gr. 2	Canvas, Barnum, Fiord, Ritz	Brass	Oiled Oak	HM2	6-8 weeks	8.50 kg	29.844	37.305
		Brass	Oiled Walnut				33.428	41.785
		Stainless Steel	Oiled Oak				29.844	37.305
		Stainless Steel	Oiled Walnut				33.428	41.785
Fabric gr. 3	Clay, Hallingdal, Steelcut Quartet, Steelcut Trio	Brass	Oiled Oak	HM2	6-8 weeks	8.50 kg	30.440	38.050
		Brass	Oiled Walnut				34.024	42.530
		Stainless Steel	Oiled Oak				30.440	38.050
		Stainless Steel	Oiled Walnut				34.024	42.530
Fabric gr. 4	Acca, Cifrado, Ecriture, Moss, Uniform Melange, Vidar	Brass	Oiled Oak	HM2	6-8 weeks	8.50 kg	31.040	38.800
		Brass	Oiled Walnut				34.624	43.280
		Stainless Steel	Oiled Oak				31.040	38.800
		Stainless Steel	Oiled Walnut				34.624	43.280
Fabric gr. 5	Karakorum, Sisu	Brass	Oiled Oak	HM2	6-8 weeks	8.50 kg	32.232	40.290
		Brass	Oiled Walnut				35.816	44.770
		Stainless Steel	Oiled Oak				32.232	40.290
		Stainless Steel	Oiled Walnut				35.816	44.770
Fabric gr. 6	Fuse, Gentle	Brass	Oiled Oak	HM2	6-8 weeks	8.50 kg	35.816	44.770
		Brass	Oiled Walnut				39.400	49.250
		Stainless Steel	Oiled Oak				35.816	44.770
		Stainless Steel	Oiled Walnut				39.400	49.250
Fabric COM	COM Fabric	Brass	Oiled Oak	HM2	6-8 weeks	8.50 kg	28.652	35.815
		Brass	Oiled Walnut				32.236	40.295
		Stainless Steel	Oiled Oak				28.652	35.815
		Stainless Steel	Oiled Walnut				32.236	40.295

Frame	Finish
Wood	Oiled Oak, Oiled Walnut
Metal	Brass, Stainless Steel

Material: Wood, HR foam, polyester wadding, fabric upholstery, brass, and stainless steel.

Fabric usage: 2 meters based on a 140cm roll.

COM must be approved by &Tradition to ensure suitability for upholstery.

HM2 is not available in leather.

Plastic gliders are installed as standard.

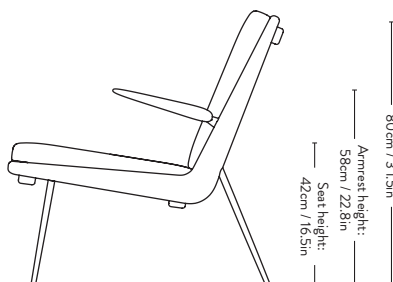
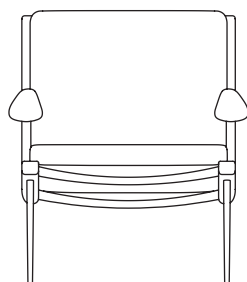

69cm / 27.2in

79cm / 31in

50cm / 19.7in

80cm / 31.5in
Armrest height:
58cm / 22.8in
Seat height:
42cm / 16.5in

X HM10

Hvidt & Mølgaard 1959



Item code	Product	Model	Colli qty.	Lead time	Weight	PRICE EX. VAT (SEK)	PRICE INC. VAT (SEK)
15120092	Oak w. walnut inserts and natural rattan	HM10	1 pc	Stock item	6.27 kg	11.936	14.920

Material: Water based lacquered oak veneer w. solid walnut inserts and natural rattan seat

Plastic gliders are installed as standard, and interchangeable felt gliders are available upon request.

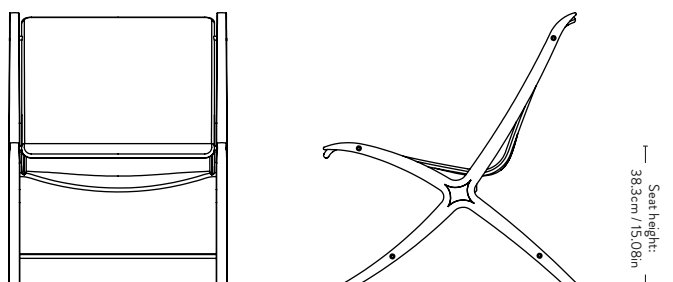

NEW

AX^{HM11} Hvidt & Mølgaard 1950

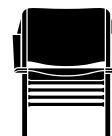

Item code	Product	Model	Colli qty.	Lead time	Weight	PRICE EX. VAT (SEK)	PRICE INC. VAT (SEK)
15100096	Oak and Walnut	HM11	1 pc	Stock item	6.20 kg	11.936	14.920
15100097	Dark Stained Oak	HM11	1 pc	Stock item	6.20 kg	11.936	14.920

Material: Water based lacquered oak veneer, walnut veneer, and solid walnut inserts

Plastic gliders are installed as standard, and interchangeable felt gliders are available upon request.

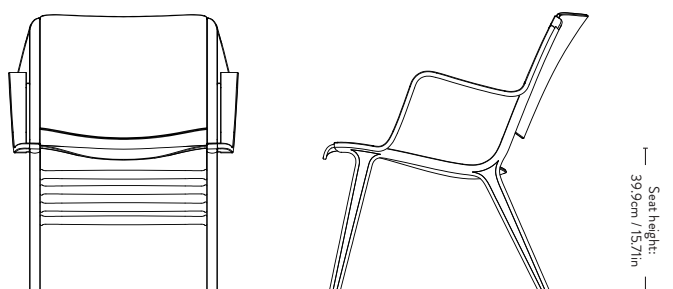

Drawn^{HM3 & HM4} Hvidt & Mølgaard 1956

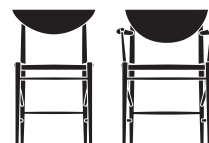

Item code	Upholstery	Model	Colli qty.	Lead time	Weight	PRICE EX. VAT (SEK)	PRICE INC. VAT (SEK)
14030092	Oiled Oak w. Natural Paper Cord	HM3	1 pc	Stock item	4.50 kg	6.920	8.650
14030094	Black Oak w. Natural Paper Cord	HM3	1 pc	Stock item	4.30 kg	6.920	8.650
14030096	Walnut w. Natural Paper Cord	HM3	1 pc	Stock item	4.50 kg	7.756	9.695
14040092	Oiled Oak w. Natural Paper Cord	HM4	1 pc	Stock item	6.00 kg	9.308	11.635
14040094	Black Oak with Natural Paper Cord	HM4	1 pc	Stock item	5.70 kg	9.308	11.635
14040096	Walnut w. Natural Paper Cord	HM4	1 pc	Stock item	6.00 kg	10.500	13.125

Item code	Upholstery	Model	Colli qty.	Lead time	Weight	PRICE EX. VAT (SEK)	PRICE INC. VAT (SEK)
14100107	Drawn Seat Pad w. Black Prescott Leather	HM3	1 pc	Stock item	0.60 kg	888	1.110
14100207	Drawn Seat Pad w. Cognac Prescott Leather	HM3	1 pc	Stock item	0.60 kg	888	1.110
14100307	Drawn Seat Pad w. Black Prescott Leather	HM4	1 pc	Stock item	0.70 kg	1.068	1.335
14100407	Drawn Seat Pad w. Cognac Prescott Leather	HM4	1 pc	Stock item	0.70 kg	1.068	1.335

Frame

Oiled Oak
Black water based lacquered Oak
Oiled Walnut

Seat

Natural Paper Cord

Material: Solid wood, formpressed wood veneer & paper cord.

Wagner QuickClick Plast gliders are installed as standard.
Wagner QuickClick Felt gliders available upon request.

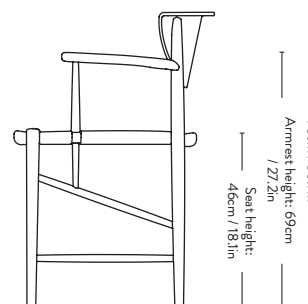
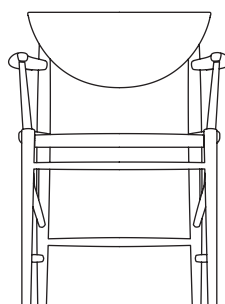
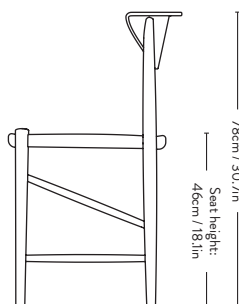
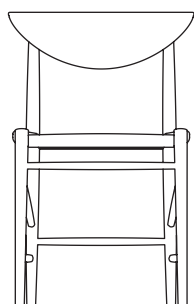

Little Petra^{VB1}

Viggo Boesen

1938



Item no.	Upholstery	Model	Base	Lead time	Weight	PRICE EX. VAT (SEK)	PRICE INC. VAT (SEK)
69113203	Karakorum 003	VB1	Oak	2-4 weeks	20.00 kg	29.844	37.305
69113204	Karakorum 003	VB1	Walnut	2-4 weeks	20.00 kg	29.844	37.305
69113205	Sheepskin Moonlight 17mm	VB1	Oak	Stock item	20.00 kg	40.592	50.740
69113206	Sheepskin Moonlight 17mm	VB1	Walnut	Stock item	20.00 kg	40.592	50.740
69113207	Sheepskin Sahara 17mm	VB1	Oak	Stock item	20.00 kg	40.592	50.740
69113208	Sheepskin Sahara 17mm	VB1	Walnut	Stock item	20.00 kg	40.592	50.740
69113209	Sheepskin Honey 50mm	VB1	Oak	2-4 weeks	20.00 kg	40.592	50.740
69113210	Sheepskin Honey 50mm	VB1	Walnut	2-4 weeks	20.00 kg	40.592	50.740

Item no.	Upholstery	Model	Base	Lead time	Weight	PRICE EX. VAT (SEK)	PRICE INC. VAT (SEK)
Fabric gr. 2	Canvas, Barnum, Fiord, Ritz	VB1	Oak	6-8 weeks	20.00 kg	26.264	32.830
		VB1	Walnut	6-8 weeks	20.00 kg		
Fabric gr. 3	Clay, Hallingdal, Steelcut Quartet, Steelcut Trio	VB1	Oak	6-8 weeks	20.00 kg	27.456	34.320
		VB1	Walnut	6-8 weeks	20.00 kg		
Fabric gr. 4	Acca, Cifrado, Ecriture, Moss, Uniform Melange, Vidar	VB1	Oak	6-8 weeks	20.00 kg	28.652	35.815
		VB1	Walnut	6-8 weeks	20.00 kg		
Fabric gr. 5	Karakorum, Sisu	VB1	Oak	6-8 weeks	20.00 kg	34.620	43.275
		VB1	Walnut	6-8 weeks	20.00 kg		
Fabric gr. 6	Gentle	VB1	Oak	6-8 weeks	20.00 kg	38.204	47.755
		VB1	Walnut	6-8 weeks	20.00 kg		
Sheepskin MTO	Sheepskin 17mm, Sheepskin 50mm	VB1	Oak	6-8 weeks	20.00 kg	47.756	59.695
		VB1	Walnut	6-8 weeks	20.00 kg		
Fabric COM	COM Fabric	VB1	Oak	6-8 weeks	20.00 kg	26.264	32.830
		VB1	Walnut	6-8 weeks	20.00 kg		

As with most natural materials, differences in structure, density and thickness are expected, as two pieces of sheepskin never look identical and tend to show natural variations in both curls and tones.

Base Finish

Solid Oak Oiled Oak
Solid Walnut Oiled Walnut

Material: Wood, HR foam, polyester wadding, fabric upholstery.

Fabric usage: 3.5 meters based on a 140cm roll.

COM must be approved by &Tradition to ensure suitability for upholstery.

Little Petra VB1 is not available in leather.

Felt gliders installed as standard.

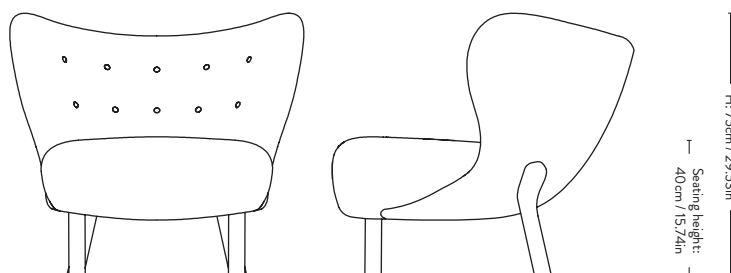

Little Petra^{VB2} Viggo Boesen 1938

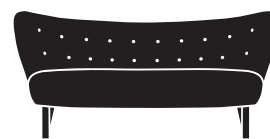

Item no.	Upholstery	Model	Base	Lead time	Weight	PRICE EX. VAT (SEK)	PRICE INC. VAT (SEK)
69113406	Karakorum 003	VB2	Oak	2-4 weeks	35.00 kg	44.172	55.215
69113405	Karakorum 003	VB2	Walnut	2-4 weeks	35.00 kg	44.172	55.215
69113402	Sheepskin Moonlight 17mm	VB2	Oak	Stock item	35.00 kg	59.696	74.620
69113401	Sheepskin Moonlight 17mm	VB2	Walnut	Stock item	35.00 kg	59.696	74.620
69113404	Sheepskin Sahara 17mm	VB2	Oak	Stock item	35.00 kg	59.696	74.620
69113403	Sheepskin Sahara 17mm	VB2	Walnut	Stock item	35.00 kg	59.696	74.620

Item no.	Upholstery	Model	Base	Lead time	Weight	PRICE EX. VAT (SEK)	PRICE INC. VAT (SEK)
Fabric gr. 2	Canvas, Barnum, Fiord, Ritz	VB2	Oak	6-8 weeks	35.00 kg	43.576	54.470
		VB2	Walnut	6-8 weeks	35.00 kg		
Fabric gr. 3	Clay, Hallingdal, Steelcut Quartet, Steelcut Trio	VB2	Oak	6-8 weeks	35.00 kg	44.772	55.965
		VB2	Walnut	6-8 weeks	35.00 kg		
Fabric gr. 4	Acca, Cifrado, Ecriture, Moss, Uniform Melange, Vidar	VB2	Oak	6-8 weeks	35.00 kg	47.160	58.950
		VB2	Walnut	6-8 weeks	35.00 kg		
Fabric gr. 5	Karakorum, Sisu	VB2	Oak	6-8 weeks	35.00 kg	52.532	65.665
		VB2	Walnut	6-8 weeks	35.00 kg		
Fabric gr. 6	Gentle	VB2	Oak	6-8 weeks	35.00 kg	57.904	72.380
		VB2	Walnut	6-8 weeks	35.00 kg		
Sheepskin MTO	Sheepskin 17mm, Sheepskin 50mm	VB2	Oak	6-8 weeks	35.00 kg	65.664	82.080
		VB2	Walnut	6-8 weeks	35.00 kg		
Fabric COM	COM Fabric	VB2	Oak	6-8 weeks	35.00 kg	43.576	54.470
		VB2	Walnut	6-8 weeks	35.00 kg		

As with most natural materials, differences in structure, density and thickness are expected, as two pieces of sheepskin never look identical and tend to show natural variations in both curls and tones.

Base Finish

Solid Oak Oiled Oak
Solid Walnut Oiled Walnut

Material: Wood, HR foam, polyester wadding, fabric upholstery.

Fabric usage: 5.6 meters based on a 140cm roll.

COM must be approved by &Tradition to ensure suitability for upholstery.

Little Petra VB2 is not available in leather.

Felt gliders installed as standard.

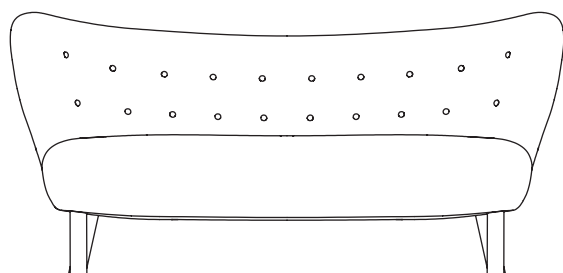

NEW

Petra^{VB3}

Viggo Boesen

1938



Item no.	Upholstery	Model	Base	Lead time	Weight	PRICE EX. VAT (SEK)	PRICE INC. VAT (SEK)
69113510	Karakorum 003	VB3	Oak	2-4 weeks	26.50 kg	35.816	44.770
69113511	Karakorum 003	VB3	Walnut	2-4 weeks	26.50 kg	35.816	44.770
69113504	Sheepskin Moonlight 17mm	VB3	Oak	2-4 weeks	26.50 kg	59.696	74.620
69113505	Sheepskin Moonlight 17mm	VB3	Walnut	2-4 weeks	26.50 kg	59.696	74.620
69113506	Sheepskin Sahara 17mm	VB3	Oak	2-4 weeks	26.50 kg	59.696	74.620
69113507	Sheepskin Sahara 17mm	VB3	Walnut	2-4 weeks	26.50 kg	59.696	74.620
69113512	Sheepskin Honey 50 mm	VB3	Oak	2-4 weeks	26.50 kg	59.696	74.620
69113513	Sheepskin Honey 50 mm	VB3	Walnut	2-4 weeks	26.50 kg	59.696	74.620

Item no.	Upholstery	Model	Base	Lead time	Weight	PRICE EX. VAT (SEK)	PRICE INC. VAT (SEK)
Fabric gr. 2	Canvas, Barnum, Fiord, Ritz	VB3	Oak	6-8 weeks	26.50 kg	32.232	40.290
		VB3	Walnut	6-8 weeks	26.50 kg		
Fabric gr. 3	Clay, Hallingdal, Steelcut Quartet, Steelcut Trio	VB3	Oak	6-8 weeks	26.50 kg	33.428	41.785
		VB3	Walnut	6-8 weeks	26.50 kg		
Fabric gr. 4	Acca, Cifrado, Ecriture, Moss, Uniform Melange, Vidar	VB3	Oak	6-8 weeks	26.50 kg	34.620	43.275
		VB3	Walnut	6-8 weeks	26.50 kg		
Fabric gr. 5	Karakorum, Sisu	VB3	Oak	6-8 weeks	26.50 kg	40.592	50.740
		VB3	Walnut	6-8 weeks	26.50 kg		
Fabric gr. 6	Gentle	VB3	Oak	6-8 weeks	26.50 kg	45.368	56.710
		VB3	Walnut	6-8 weeks	26.50 kg		
Sheepskin MTO	Sheepskin 17mm, Sheepskin 50mm	VB3	Oak	6-8 weeks	26.50 kg	66.860	83.575
		VB3	Walnut	6-8 weeks	26.50 kg		
Fabric COM	COM Fabric	VB2	Oak	6-8 weeks	35.00 kg	32.232	40.290
		VB2	Walnut	6-8 weeks	35.00 kg		

As with most natural materials, differences in structure, density and thickness are expected, as two pieces of sheepskin never look identical and tend to show natural variations in both curls and tones.

Base Finish

Solid Oak Oiled Oak
Solid Walnut Oiled Walnut

Material: Wood, HR foam, polyester wadding, fabric upholstery

Fabric usage: 4.4 meters based on a 140cm roll

COM must be approved by &Tradition to ensure suitability for upholstery. Petra VB3 is not available in leather. Felt gliders installed as standard.

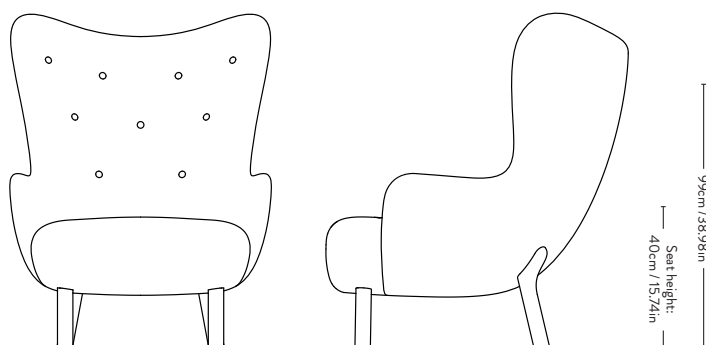

Pouf^{ATD1} &Tradition 2020



Item no.	Upholstery	Model	Base	Colli qty.	Lead time	Weight	PRICE EX. VAT (SEK)	PRICE INC. VAT (SEK)
Fabric gr. 2	Canvas, Barnum, Fiord, Ritz	ATD1	Oak	1 pc	6-8 weeks	5.20 kg	8.956	11.195
		ATD1	Walnut	1 pc	6-8 weeks	5.20 kg		
Fabric gr. 3	Clay, Hallingdal, Steelcut Quartet, Steelcut Trio	ATD1	Oak	1 pc	6-8 weeks	5.20 kg	9.252	11.565
		ATD1	Walnut	1 pc	6-8 weeks	5.20 kg		
Fabric gr. 4	Acca, Cifrado, Ecriture, Moss, Uniform Melange, Vidar	ATD1	Oak	1 pc	6-8 weeks	5.20 kg	9.312	11.640
		ATD1	Walnut	1 pc	6-8 weeks	5.20 kg		
Fabric gr. 5	Karakorum, Sisu	ATD1	Oak	1 pc	6-8 weeks	5.20 kg	9.552	11.940
		ATD1	Walnut	1 pc	6-8 weeks	5.20 kg		
Fabric gr. 6	Gentle	ATD1	Oak	1 pc	6-8 weeks	5.20 kg	10.508	13.135
		ATD1	Walnut	1 pc	6-8 weeks	5.20 kg		
Sheepskin MTO	Sheepskin 17mm, Sheepskin 50mm	ATD1	Oak	1 pc	6-8 weeks	5.20 kg	12.536	15.670
		ATD1	Walnut	1 pc	6-8 weeks	5.20 kg		
Fabric COM	COM Fabric	ATD1	Oak	1 pc	6-8 weeks	5.20 kg	8.956	11.195
		ATD1	Walnut	1 pc	6-8 weeks	5.20 kg		

As with most natural materials, differences in structure, density and thickness are expected, as two pieces of sheepskin never look identical and tend to show natural variations in both curls and tones.

Base Finish

Solid Oak Oiled Oak
Solid Walnut Oiled Walnut

Material: Wood, HR foam, polyester wadding, fabric upholstery.

Fabric usage: 1.2 meter based on a 140cm roll.

COM must be approved by &Tradition to ensure suitability for upholstery.

Pouf ATD1 is not available in leather.

Felt gliders installed as standard.

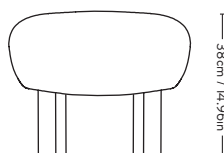

Little Petra & Pouf^{VB1 & ATD1}Viggo Boesen
1938

Item no.	Upholstery	Model	Base	Lead time	Weight	PRICE EX. VAT (SEK)	PRICE INC. VAT (SEK)
69112912	Karakorum 003	VB1 & ATD1	Oak	6-8 weeks	25.20 kg	39.396	49.245
69112913	Karakorum 003	VB1 & ATD1	Walnut	6-8 weeks	25.20 kg	39.396	49.245
69112914	Sheepskin Moonlight 17mm	VB1 & ATD1	Oak	6-8 weeks	25.20 kg	53.128	66.410
69112915	Sheepskin Moonlight 17mm	VB1 & ATD1	Walnut	6-8 weeks	25.20 kg	53.128	66.410
69112916	Sheepskin Sahara 17mm	VB1 & ATD1	Oak	6-8 weeks	25.20 kg	53.128	66.410
69112917	Sheepskin Sahara 17mm	VB1 & ATD1	Walnut	6-8 weeks	25.20 kg	53.128	66.410
69112918	Sheepskin Honey 50mm	VB1 & ATD1	Oak	6-8 weeks	25.20 kg	53.128	66.410
69112919	Sheepskin Honey 50mm	VB1 & ATD1	Walnut	6-8 weeks	25.20 kg	53.128	66.410

Item no.	Upholstery	Model	Base	Lead time	Weight	PRICE EX. VAT (SEK)	PRICE INC. VAT (SEK)
Fabric gr. 2	Canvas, Barnum, Fiord, Ritz	VB1 & ATD1	Oak	6-8 weeks	25.20 kg	35.216	44.020
		VB1 & ATD1	Walnut	6-8 weeks	25.20 kg		
Fabric gr. 3	Clay, Hallingdal, Steelcut Quartet, Steelcut Trio	VB1 & ATD1	Oak	6-8 weeks	25.20 kg	36.412	45.515
		VB1 & ATD1	Walnut	6-8 weeks	25.20 kg		
Fabric gr. 4	Acca, Cifrado, Ecriture, Moss, Uniform Melange, Vidar	VB1 & ATD1	Oak	6-8 weeks	25.20 kg	37.964	47.455
		VB1 & ATD1	Walnut	6-8 weeks	25.20 kg		
Fabric gr. 5	Karakorum, Sisu	VB1 & ATD1	Oak	6-8 weeks	25.20 kg	44.172	55.215
		VB1 & ATD1	Walnut	6-8 weeks	25.20 kg		
Fabric gr. 6	Gentle	VB1 & ATD1	Oak	6-8 weeks	25.20 kg	48.592	60.740
		VB1 & ATD1	Walnut	6-8 weeks	25.20 kg		
Sheepskin MTO	Sheepskin 17mm, Sheepskin 50mm	VB1 & ATD1	Oak	6-8 weeks	25.20 kg	60.292	75.365
		VB1 & ATD1	Walnut	6-8 weeks	25.20 kg		
Fabric COM	COM Fabric	VB1 & ATD1	Oak	6-8 weeks	25.20 kg	35.216	44.020
		VB1 & ATD1	Walnut	6-8 weeks	25.20 kg		

As with most natural materials, differences in structure, density and thickness are expected, as two pieces of sheepskin never look identical and tend to show natural variations in both curls and tones.

Base Finish

Solid Oak Oiled Oak
Solid Walnut Oiled Walnut

Material: Wood, HR foam, polyester wadding, fabric upholstery.

Fabric usage: 4.7 meters based on a 140cm roll.

COM must be approved by &Tradition to ensure suitability for upholstery. Little Petra VB1 & Pouf ATD1 are not available in leather. Felt gliders installed as standard.

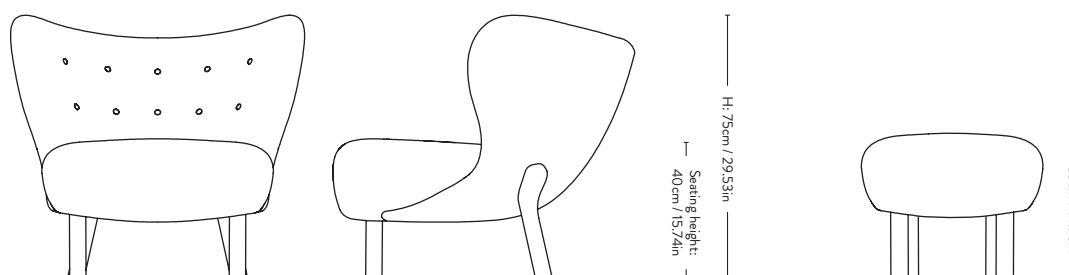

22% RABATT SKA DRAS AV PÅ ANGIVNA PRISER

NEW

Petra & Puff^{VB3 & ATD1}

Viggo Boesen

1938



Item no.	Upholstery	Model	Base	Lead time	Weight	PRICE EX. VAT (SEK)	PRICE INC. VAT (SEK)
69123511	Karakorum 003	VB3 & ATD1	Oak	6-8 weeks	31.70 kg	45.368	56.710
69123512	Karakorum 003	VB3 & ATD1	Walnut	6-8 weeks	31.70 kg	45.368	56.710
69123501	Sheepskin Moonlight 17mm	VB3 & ATD1	Oak	6-8 weeks	31.70 kg	72.828	91.035
69123502	Sheepskin Moonlight 17mm	VB3 & ATD1	Walnut	6-8 weeks	31.70 kg	72.828	91.035
69123503	Sheepskin Sahara 17mm	VB3 & ATD1	Oak	6-8 weeks	31.70 kg	72.828	91.035
69123504	Sheepskin Sahara 17mm	VB3 & ATD1	Walnut	6-8 weeks	31.70 kg	72.828	91.035
69123513	Sheepskin Honey 50 mm	VB3 & ATD1	Oak	6-8 weeks	31.70 kg	72.828	91.035
69123514	Sheepskin Honey 50 mm	VB3 & ATD1	Walnut	6-8 weeks	31.70 kg	72.828	91.035

Item no.	Upholstery	Model	Base	Lead time	Weight	PRICE EX. VAT (SEK)	PRICE INC. VAT (SEK)
Fabric gr. 2	Canvas, Barnum, Fiord, Ritz	VB3 & ATD1	Oak	6-8 weeks	31.70 kg	41.188	51.485
		VB3 & ATD1	Walnut	6-8 weeks	31.70 kg		
Fabric gr. 3	Clay, Hallingdal, Steelcut Trio, Steelcut Quartet	VB3 & ATD1	Oak	6-8 weeks	31.70 kg	42.384	52.980
		VB3 & ATD1	Walnut	6-8 weeks	31.70 kg		
Fabric gr. 4	Acca, Cifrado, Ecriture, Moss, Uniform Melange, Vidar	VB3 & ATD1	Oak	6-8 weeks	31.70 kg	43.936	54.920
		VB3 & ATD1	Walnut	6-8 weeks	31.70 kg		
Fabric gr. 5	Karakorum, Sisu	VB3 & ATD1	Oak	6-8 weeks	31.70 kg	50.144	62.680
		VB3 & ATD1	Walnut	6-8 weeks	31.70 kg		
Fabric gr. 6	Gentle	VB3 & ATD1	Oak	6-8 weeks	31.70 kg	54.920	68.650
		VB3 & ATD1	Walnut	6-8 weeks	31.70 kg		
Sheepskin MTO	Sheepskin 17mm, Sheepskin 50mm	VB3 & ATD1	Oak	6-8 weeks	31.70 kg	79.396	99.245
		VB3 & ATD1	Walnut	6-8 weeks	31.70 kg		
Fabric COM	COM Fabric	VB3 & ATD1	Oak	6-8 weeks	31.70 kg	41.188	51.485
		VB3 & ATD1	Walnut	6-8 weeks	31.70 kg		

As with most natural materials, differences in structure, density and thickness are expected, as two pieces of sheepskin never look identical and tend to show natural variations in both curls and tones.

Base Finish

Solid Oak Oiled Oak
Solid Walnut Oiled Walnut

Material: Wood, HR foam, polyester wadding,
Fabric usage: 5.6 meters based on a 140cm roll
COM must be approved by &Tradition to ensure suitability for upholstery.
Petra VB3 and Pouf ATD1 are not available in leather
Felt gliders installed as standard.

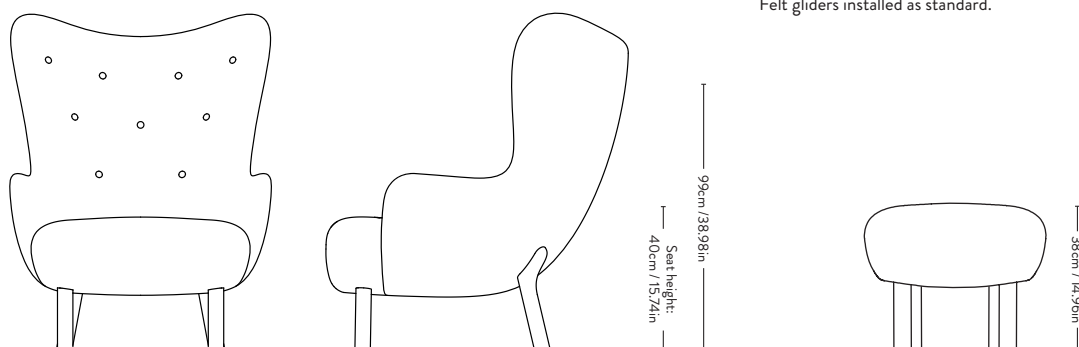

Wulff ^{ATD2} &Tradition 1938 / 2021



Item no.	Upholstery	Model	Base	Lead time	Weight	PRICE EX. VAT (SEK)	PRICE INC. VAT (SEK)
41103202	Karakorum 003	ATD2	Oak	2-4 weeks	15.00 kg	31.040	38.800
41104202		ATD2	Walnut	2-4 weeks	15.00 kg	33.428	41.785
41103204	Sheepskin Moonlight 17mm	ATD2	Oak	2-4 weeks	15.00 kg	41.784	52.230
41104204		ATD2	Walnut	2-4 weeks	15.00 kg	44.172	55.215
41103205	Sheepskin Honey 50mm	ATD2	Oak	2-4 weeks	15.00 kg	41.784	52.230
41104205		ATD2	Walnut	2-4 weeks	15.00 kg	44.172	55.215

Item no.	Upholstery	Model	Base	Lead time	Weight	PRICE EX. VAT (SEK)	PRICE INC. VAT (SEK)
Fabric gr. 1	Hot Madison, Remix, Re-Wool	ATD2	Oak	6-8 weeks	15.00 kg	26.264	32.830
		ATD2	Walnut	6-8 weeks	15.00 kg	31.040	38.800
Fabric gr. 2	Canvas, Barnum, Fiord, Ritz	ATD2	Oak	6-8 weeks	15.00 kg	27.456	34.320
		ATD2	Walnut	6-8 weeks	15.00 kg	32.232	40.290
Fabric gr. 3	Clay, Hallingdal, Steelcut Quartet, Steelcut Trio	ATD2	Oak	6-8 weeks	15.00 kg	28.652	35.815
		ATD2	Walnut	6-8 weeks	15.00 kg	33.428	41.785
Fabric gr. 4	Acca, Cifrado, Ecriture, Moss, Uniform Melange, Vidar	ATD2	Oak	6-8 weeks	15.00 kg	29.844	37.305
		ATD2	Walnut	6-8 weeks	15.00 kg	34.620	43.275
Fabric gr. 5	Karakorum, Sisu	ATD2	Oak	6-8 weeks	15.00 kg	35.816	44.770
		ATD2	Walnut	6-8 weeks	15.00 kg	40.592	50.740
Fabric gr. 6	Gentle	ATD2	Oak	6-8 weeks	15.00 kg	39.396	49.245
		ATD2	Walnut	6-8 weeks	15.00 kg	44.772	55.965
Sheepskin MTO	Sheepskin 17mm, Sheepskin 50mm	ATD2	Oak	6-8 weeks	15.00 kg	47.696	59.620
		ATD2	Walnut	6-8 weeks	15.00 kg	52.472	65.590
Fabric COM	COM Fabric	ATD2	Oak	6-8 weeks	15.00 kg	26.264	32.830
		ATD2	Walnut	6-8 weeks	15.00 kg	31.040	38.800

As with most natural materials, differences in structure, density and thickness are expected, as two pieces of sheepskin never look identical and tend to show natural variations in both curls and tones.

Material: Oiled wood, HR foam, polyester wadding, fabric upholstery.

Fabric usage: 2.5 meters based on a 140cm roll.

COM must be approved by &Tradition to ensure suitability for upholstery.

Wulff ATD2 is not available in leather.

Felt gliders installed as standard.

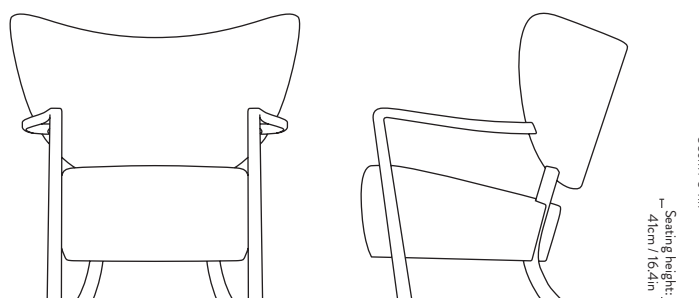

Wulff ^{ATD3} &Tradition 2022



	Upholstery	Model	Base	Lead time	Weight	PRICE EX. VAT (SEK)	PRICE INC. VAT (SEK)
Fabric gr. 1	Hot Madison, Remix, Re-Wool	ATD3	Oak	6-8 weeks	6.70 kg	10.740	13.425
		ATD3	Walnut	6-8 weeks	6.70 kg	11.336	14.170
Fabric gr. 2	Canvas, Barnum, Fiord, Ritz	ATD3	Oak	6-8 weeks	6.70 kg	11.336	14.170
		ATD3	Walnut	6-8 weeks	6.70 kg	11.936	14.920
Fabric gr. 3	Clay, Hallingdal, Steelcut Quartet, Steelcut Trio	ATD3	Oak	6-8 weeks	6.70 kg	11.936	14.920
		ATD3	Walnut	6-8 weeks	6.70 kg	12.532	15.665
Fabric gr. 4	Acca, Cifrado, Ecriture, Moss, Uniform Melange, Vidar	ATD3	Oak	6-8 weeks	6.70 kg	12.532	15.665
		ATD3	Walnut	6-8 weeks	6.70 kg	13.128	16.410
Fabric gr. 5	Karakorum, Sisu	ATD3	Oak	6-8 weeks	6.70 kg	14.324	17.905
		ATD3	Walnut	6-8 weeks	6.70 kg	14.920	18.650
Fabric gr. 6	Gentle	ATD3	Oak	6-8 weeks	6.70 kg	15.516	19.395
		ATD3	Walnut	6-8 weeks	6.70 kg	16.712	20.890
Sheepskin MTO	Sheepskin 17mm, Sheepskin 50mm	ATD3	Oak	6-8 weeks	6.70 kg	16.112	20.140
		ATD3	Walnut	6-8 weeks	6.70 kg	16.712	20.890
Fabric COM	COM Fabric	ATD3	Oak	6-8 weeks	6.70 kg	10.740	13.425
		ATD3	Walnut	6-8 weeks	6.70 kg	11.336	14.170

As with most natural materials, differences in structure, density and thickness are expected, as two pieces of sheepskin never look identical and tend to show natural variations in both curls and tones.

Material: Oiled wood, HR foam, polyester wadding, fabric upholstery.

Fabric usage: 1.3 meters based on a 140cm roll.

COM must be approved by &Tradition to ensure suitability for upholstery.

Wulff ATD3 is not available in leather.

Felt gliders installed as standard.

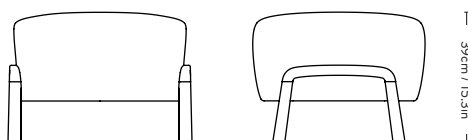

Wulff ATD2 & ATD3 &Tradition 2022



Item no.	Upholstery	Model	Base	Lead time	Weight	PRICE EX. VAT (SEK)	PRICE INC. VAT (SEK)
41105202	Karakorum 003	ATD2 & ATD3	Oak	6-8 weeks	21.70 kg	41.784	52.230
41106202		ATD2 & ATD3	Walnut	6-8 weeks	21.70 kg	44.772	55.965
41105204	Sheepskin Moonlight 17mm	ATD2 & ATD3	Oak	6-8 weeks	21.70 kg	54.324	67.905
41106204		ATD2 & ATD3	Walnut	6-8 weeks	21.70 kg	57.308	71.635
41105205	Sheepskin Honey 50mm	ATD2 & ATD3	Oak	6-8 weeks	21.70 kg	54.324	67.905
41106205		ATD2 & ATD3	Walnut	6-8 weeks	21.70 kg	57.308	71.635

	Upholstery	Model	Base	Lead time	Weight	PRICE EX. VAT (SEK)	PRICE INC. VAT (SEK)
Fabric gr. 1	Hot Madison, Remix, Re-Wool	ATD2 & ATD3	Oak	6-8 weeks	21.70 kg	33.428	41.785
		ATD2 & ATD3	Walnut	6-8 weeks	21.70 kg	38.800	48.500
Fabric gr. 2	Canvas, Barnum, Fiord, Ritz	ATD2 & ATD3	Oak	6-8 weeks	21.70 kg	35.216	44.020
		ATD2 & ATD3	Walnut	6-8 weeks	21.70 kg	40.592	50.740
Fabric gr. 3	Clay, Hallingdal, Steelcut Quartet, Steelcut Trio	ATD2 & ATD3	Oak	6-8 weeks	21.70 kg	36.412	45.515
		ATD2 & ATD3	Walnut	6-8 weeks	21.70 kg	41.784	52.230
Fabric gr. 4	Acca, Cifrado, Ecriture, Moss, Uniform Melange, Vidar	ATD2 & ATD3	Oak	6-8 weeks	21.70 kg	38.800	48.500
		ATD2 & ATD3	Walnut	6-8 weeks	21.70 kg	44.172	55.215
Fabric gr. 5	Karakorum, Sisu	ATD2 & ATD3	Oak	6-8 weeks	21.70 kg	46.560	58.200
		ATD2 & ATD3	Walnut	6-8 weeks	21.70 kg	51.936	64.920
Fabric gr. 6	Gentle	ATD2 & ATD3	Oak	6-8 weeks	21.70 kg	51.336	64.170
		ATD2 & ATD3	Walnut	6-8 weeks	21.70 kg	57.904	72.380
Sheepskin MTO	Sheepskin 17mm, Sheepskin 50mm	ATD2 & ATD3	Oak	6-8 weeks	21.70 kg	60.232	75.290
		ATD2 & ATD3	Walnut	6-8 weeks	21.70 kg	65.604	82.005
Fabric COM	COM Fabric	ATD2 & ATD3	Oak	6-8 weeks	21.70 kg	33.428	41.785
		ATD2 & ATD3	Walnut	6-8 weeks	21.70 kg	38.800	48.500

As with most natural materials, differences in structure, density and thickness are expected, as two pieces of sheepskin never look identical and tend to show natural variations in both curls and tones.

Material: Oiled wood, HR foam, polyester wadding, fabric upholstery.

Fabric usage: 3.8 meters based on a 140cm roll.

COM must be approved by &Tradition to ensure suitability for upholstery.

Wulff ATD2 & ATD3 are not available in leather.

Felt gliders installed as standard.

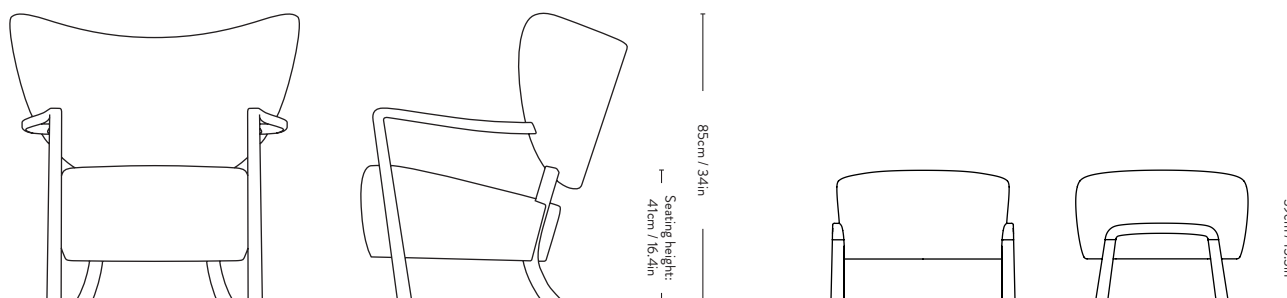

Margas LC1

Liljencrantz

2022

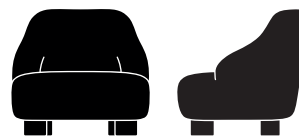

Item no.	Upholstery	Base	Model	Lead time	Weight	PRICE EX. VAT (SEK)	PRICE INC. VAT (SEK)
11500202	Karakorum 001	Black Oak	LC1	2-4 weeks	26.0 kg	25.068	31.335
11500402		Oak	LC1	2-4 weeks	26.0 kg	25.068	31.335
11500602		Walnut	LC1	2-4 weeks	26.0 kg	28.652	35.815
11500205	Clay 0011	Black Oak	LC1	2-4 weeks	26.0 kg	23.276	29.095
11500405		Oak	LC1	2-4 weeks	26.0 kg	23.276	29.095
11500605		Walnut	LC1	2-4 weeks	26.0 kg	26.860	33.575

	Upholstery	Base	Model	Lead time	Weight	PRICE EX. VAT (SEK)	PRICE INC. VAT (SEK)
Fabric gr. 1	Hot Madison, Remix, Re-Wool	Black Oak	LC1	6-8 weeks	26.0 kg	20.292	25.365
		Oak	LC1	6-8 weeks	26.0 kg	20.292	25.365
		Walnut	LC1	6-8 weeks	26.0 kg	23.876	29.845
Fabric gr. 2	Canvas, Barnum, Fiord, Ritz	Black Oak	LC1	6-8 weeks	26.0 kg	22.680	28.350
		Oak	LC1	6-8 weeks	26.0 kg	22.680	28.350
		Walnut	LC1	6-8 weeks	26.0 kg	26.264	32.830
Fabric gr. 3	Clay, Hallingdal, Steelcut Quartet, Steelcut Trio	Black Oak	LC1	6-8 weeks	26.0 kg	23.276	29.095
		Oak	LC1	6-8 weeks	26.0 kg	23.276	29.095
		Walnut	LC1	6-8 weeks	26.0 kg	26.860	33.575
Fabric gr. 4	Acca, Cifrado, Ecriture, Moss, Uniform Melange, Vidar	Black Oak	LC1	6-8 weeks	26.0 kg	23.876	29.845
		Oak	LC1	6-8 weeks	26.0 kg	23.876	29.845
		Walnut	LC1	6-8 weeks	26.0 kg	27.456	34.320
Fabric gr. 5	Karakorum, Sisu	Black Oak	LC1	6-8 weeks	26.0 kg	28.652	35.815
		Oak	LC1	6-8 weeks	26.0 kg	28.652	35.815
		Walnut	LC1	6-8 weeks	26.0 kg	32.232	40.290
Fabric gr. 6	Gentle	Black Oak	LC1	6-8 weeks	26.0 kg	31.636	39.545
		Oak	LC1	6-8 weeks	26.0 kg	31.636	39.545
		Walnut	LC1	6-8 weeks	26.0 kg	35.816	44.770
COM Fabric	COM Fabric	Black Oak	LC1	6-8 weeks	26.0 kg	20.292	25.365
		Oak	LC1	6-8 weeks	26.0 kg	20.292	25.365
		Walnut	LC1	6-8 weeks	26.0 kg	23.876	29.845

Material: Wood, HR foam, polyester wadding, fabric upholstery.

Frame: Black water based lacquered Oak, Oiled Oak or Oiled Walnut

Fabric usage: 2.8 meters based on a 140cm roll. COM must be approved by &Tradition to ensure suitability for upholstery.

Margas LC1 is not available in leather.

Felt gliders installed as standard.

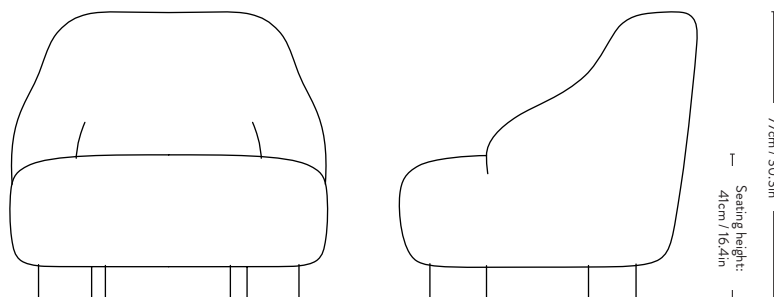

Margas LC2

Liljencrantz

2022

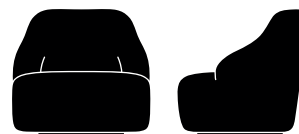

Item no.	Upholstery	Base	Model	Lead time	Weight	PRICE EX. VAT (SEK)	PRICE INC. VAT (SEK)
11550202	Karakorum 001	Black Swivel	LC2	2-4 weeks	32.0 kg	25.068	31.335
11550205	Clay 0011	Black Swivel	LC2	2-4 weeks	32.0 kg	20.292	25.365

	Upholstery	Base	Model	Lead time	Weight	PRICE EX. VAT (SEK)	PRICE INC. VAT (SEK)
Fabric gr. 1	Hot Madison, Remix, Re-Wool	Black Swivel	LC2	6-8 weeks	32.0 kg	20.292	25.365
Fabric gr. 2	Canvas, Barnum, Fiord, Ritz	Black Swivel	LC2	6-8 weeks	32.0 kg	22.680	28.350
Fabric gr. 3	Clay, Hallingdal, Steelcut Quartet, Steelcut Trio	Black Swivel	LC2	6-8 weeks	32.0 kg	23.276	29.095
Fabric gr. 4	Acca, Cifrado, Ecriture, Moss, Uniform Melange, Vidar	Black Swivel	LC2	6-8 weeks	32.0 kg	23.876	29.845
Fabric gr. 5	Karakorum, Sisu	Black Swivel	LC2	6-8 weeks	32.0 kg	28.652	35.815
Fabric gr. 6	Gentle	Black Swivel	LC2	6-8 weeks	32.0 kg	31.636	39.545
COM Fabric	COM Fabric	Black Swivel	LC2	6-8 weeks	32.0 kg	20.292	25.365

Material: Wood, HR foam, polyester wadding, fabric upholstery.

Fabric usage: 2.8 meters based on a 140cm roll.
COM must be approved by &Tradition to ensure suitability for upholstery.

Margas LC2 is not available in leather.

Felt gliders installed as standard.
Swivel w. return function.

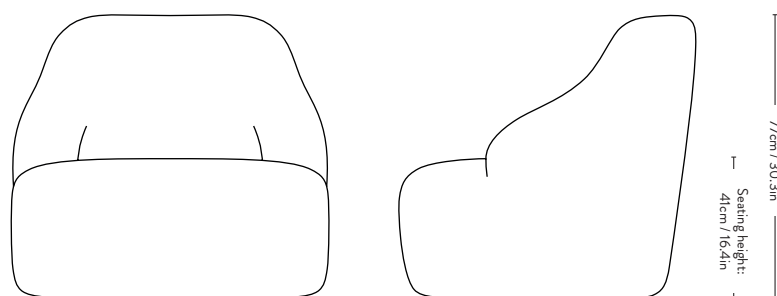

Margas LC3

Liljencrantz

2022



Item no.	Upholstery	Base	Model	Lead time	Weight	PRICE EX. VAT (SEK)	PRICE INC. VAT (SEK)
11600202	Karakorum 001	Black Oak	LC3	2-4 weeks	38.0 kg	34.620	43.275
11600402		Oak	LC3	2-4 weeks	38.0 kg	34.620	43.275
11600602		Walnut	LC3	2-4 weeks	38.0 kg	38.204	47.755
11600205	Clay 0011	Black Oak	LC3	2-4 weeks	38.0 kg	32.232	40.290
11600405		Oak	LC3	2-4 weeks	38.0 kg	32.232	40.290
11600605		Walnut	LC3	2-4 weeks	38.0 kg	35.816	44.770

	Upholstery	Base	Model	Lead time	Weight	PRICE EX. VAT (SEK)	PRICE INC. VAT (SEK)
Fabric gr. 1	Hot Madison, Remix, Re-Wool	Black Oak, Oak	LC3	6-8 weeks	38.0 kg	27.456	34.320
		Walnut	LC3	6-8 weeks	38.0 kg	31.040	38.800
Fabric gr. 2	Canvas, Barnum, Fiord, Ritz	Black Oak, Oak	LC3	6-8 weeks	38.0 kg	31.040	38.800
		Walnut	LC3	6-8 weeks	38.0 kg	34.620	43.275
Fabric gr. 3	Clay, Hallingdal, Steelcut Quartet, Steelcut Trio	Black Oak, Oak	LC3	6-8 weeks	38.0 kg	32.232	40.290
		Walnut	LC3	6-8 weeks	38.0 kg	35.816	44.770
Fabric gr. 4	Acca, Cifrado, Ecriture, Moss, Uniform Melange, Vidar	Black Oak, Oak	LC3	6-8 weeks	38.0 kg	33.428	41.785
		Walnut	LC3	6-8 weeks	38.0 kg	37.008	46.260
Fabric gr. 5	Karakorum, Sisu	Black Oak, Oak	LC3	6-8 weeks	38.0 kg	38.204	47.755
		Walnut	LC3	6-8 weeks	38.0 kg	41.784	52.230
Fabric gr. 6	Gentle	Black Oak, Oak	LC3	6-8 weeks	38.0 kg	41.784	52.230
		Walnut	LC3	6-8 weeks	38.0 kg	45.964	57.455
COM Fabric	COM Fabric	Black Oak, Oak	LC3	6-8 weeks	38.0 kg	27.456	34.320
		Walnut	LC3	6-8 weeks	38.0 kg	31.040	38.800

Material: Wood, HR foam, polyester wadding, fabric upholstery.

Frame: Black water based lacquered Oak, Oiled Oak or Oiled Walnut

Fabric usage: 4.2 meters based on a 140cm roll.

COM must be approved by &Tradition to ensure suitability for upholstery.

Margas LC3 is not available in leather.

Felt gliders installed as standard.

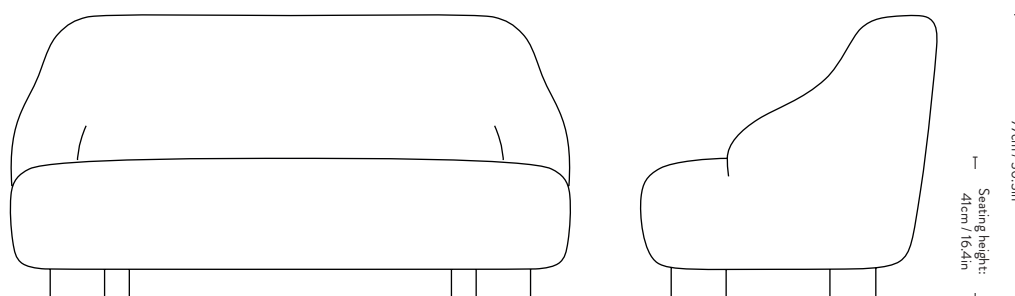

Loafer ^{SC24}

Space Copenhagen

2019



Price gr.	Upholstery	Model	Lead time	Weight	PRICE EX. VAT (SEK)	PRICE INC. VAT (SEK)
Fabric gr. 1	Hot Madison, Remix, Re-Wool	SC24	6-8 weeks	15.50 kg	12.532	15.665
Fabric gr. 2	Canvas, Barnum, Fiord, Ritz	SC24	6-8 weeks	15.50 kg	13.724	17.155
Fabric gr. 3	Clay, Hallingdal, Steelcut Quartet, Steelcut Trio	SC24	6-8 weeks	15.50 kg	14.324	17.905
Fabric gr. 4	Acca, Cifrado, Ecriture, Moss, Uniform Melange, Vidar	SC24	6-8 weeks	15.50 kg	16.112	20.140
Fabric gr. 5	Karakorum, Sisu	SC24	6-8 weeks	15.50 kg	19.696	24.620
Fabric gr. 6	Fuse, Gentle	SC24	6-8 weeks	15.50 kg	21.488	26.860
Leather	Noble Aniline leather	SC24	6-8 weeks	15.50 kg	24.472	30.590
Leather	Elmosoft Semi-aniline leather	SC24	6-8 weeks	15.50 kg	29.248	36.560
COM	COM Fabric	SC24	6-8 weeks	15.50 kg	12.532	15.665

Material: Wood, HR foam, polyester wadding, fabric upholstery.

Fabric usage: 2.7 meters based on 140cm roll.

Leather usage: 6.4 square meters based on a yield of 60% pr hide.

COM must be approved by &Tradition to ensure suitability for upholstery.

Plastic gliders installed as standard.

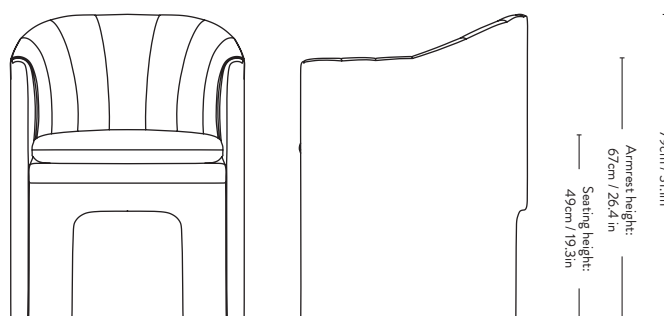

Loafer SC23

Space Copenhagen

2018



Price gr.	Upholstery	Model	Lead time	Weight	PRICE EX. VAT (SEK)	PRICE INC. VAT (SEK)
Fabric gr. 1	Hot Madison, Remix, Re-Wool	SC23	6-8 weeks	26.00 kg	14.920	18.650
Fabric gr. 2	Canvas, Barnum, Fiord, Ritz	SC23	6-8 weeks	26.00 kg	16.112	20.140
Fabric gr. 3	Clay, Hallingdal, Steelcut Quartet, Steelcut Trio	SC23	6-8 weeks	26.00 kg	16.712	20.890
Fabric gr. 4	Acca, Cifrado, Ecriture, Moss, Uniform Melange, Vidar	SC23	6-8 weeks	26.00 kg	18.500	23.125
Fabric gr. 5	Karakorum, Sisu	SC23	6-8 weeks	26.00 kg	22.084	27.605
Fabric gr. 6	Fuse, Gentle	SC23	6-8 weeks	26.00 kg	24.472	30.590
Leather	Noble Aniline leather	SC23	6-8 weeks	26.00 kg	25.664	32.080
Leather	Elmosoft Semi-aniline leather	SC23	6-8 weeks	26.00 kg	30.440	38.050
Sheepskin MTO	Sheepskin 17mm	SC23	6-8 weeks	26.00 kg	36.412	45.515
COM	COM Fabric	SC23	6-8 weeks	26.00 kg	14.920	18.650

As with most natural materials, differences in structure, density and thickness are expected, as two pieces of sheepskin never look identical and tend to show natural variations in both curls and tones.

Material: Wood, HR foam, polyester wadding, fabric upholstery.

Fabric usage: 3.3 meters based on 140cm roll.

Leather usage: 7.7 square meters based on a yield of 60% pr hide.

COM must be approved by &Tradition to ensure suitability for upholstery.

Felt gliders installed as standard.

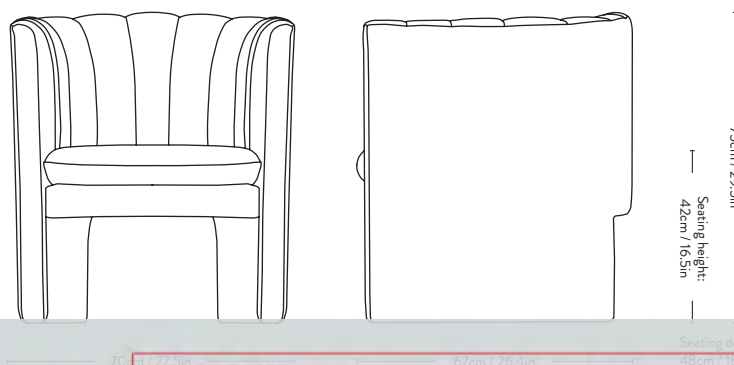

Loafer SC25

Space Copenhagen

2019



Price gr.	Upholstery	Model	Lead time	Weight	PRICE EX. VAT (SEK)	PRICE INC. VAT (SEK)
Fabric gr. 1	Hot Madison, Remix, Re-Wool	SC25	6-8 weeks	36.00 kg	31.040	38.800
Fabric gr. 2	Canvas, Barnum, Fiord, Ritz	SC25	6-8 weeks	36.00 kg	34.620	43.275
Fabric gr. 3	Clay, Hallingdal, Steelcut Quartet, Steelcut Trio	SC25	6-8 weeks	36.00 kg	35.816	44.770
Fabric gr. 4	Acca, Cifrado, Ecriture, Moss, Uniform Melange, Vidar	SC25	6-8 weeks	36.00 kg	40.592	50.740
Fabric gr. 5	Karakorum, Sisu	SC25	6-8 weeks	36.00 kg	42.980	53.725
Fabric gr. 6	Fuse, Gentle	SC25	6-8 weeks	36.00 kg	47.160	58.950
Leather	Noble Aniline leather	SC25	6-8 weeks	36.00 kg	46.560	58.200
Leather	Elmosoft Semi-aniline leather	SC25	6-8 weeks	36.00 kg	56.112	70.140
COM	COM Fabric	SC25	6-8 weeks	36.00 kg	31.040	38.800

Material: Wood, HR foam, polyester wadding, fabric upholstery.

Fabric usage: 5.8 meters based on 140cm roll.

Leather usage: 11 square meters based on a yield of 60% pr hide.

COM must be approved by &Tradition to ensure suitability for upholstery.

Felt gliders installed as standard.

Customized sizes available upon request.

Extra height: 10% upcharge

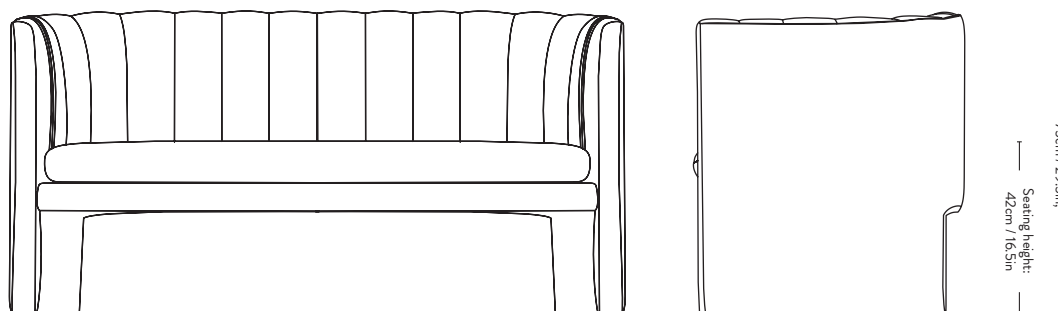

Loafer^{SC26} Space Copenhagen 2019



Price gr.	Upholstery	Model	Lead time	Weight	PRICE EX. VAT (SEK)	PRICE INC. VAT (SEK)
Fabric gr. 1	Hot Madison, Remix, Re-Wool	SC26	6-8 weeks	45.00 kg	34.024	42.530
Fabric gr. 2	Canvas, Barnum, Fiord, Ritz	SC26	6-8 weeks	45.00 kg	37.604	47.005
Fabric gr. 3	Clay, Hallingdal, Steelcut Quartet, Steelcut Trio	SC26	6-8 weeks	45.00 kg	38.800	48.500
Fabric gr. 4	Acca, Cifrado, Ecriture, Moss, Uniform Melange, Vidar	SC26	6-8 weeks	45.00 kg	43.576	54.470
Fabric gr. 5	Karakorum, Sisu	SC26	6-8 weeks	45.00 kg	45.964	57.455
Fabric gr. 6	Fuse, Gentle	SC26	6-8 weeks	45.00 kg	50.740	63.425
Leather	Noble Aniline leather	SC26	6-8 weeks	45.00 kg	49.548	61.935
Leather	Elmosoft Semi-aniline leather	SC26	6-8 weeks	45.00 kg	59.456	74.320
COM	COM Fabric	SC26	6-8 weeks	45.00 kg	34.024	42.530

Material: Wood, HR foam, polyester wadding, fabric upholstery.

Fabric usage: 6.7 meters based on 140cm roll.

Leather usage: 12.7 square meters based on a yield of 60% pr hide.

COM must be approved by &Tradition to ensure suitability for upholstery.

Felt gliders installed as standard.

Customized sizes available upon request.

Extra height: 10% upcharge

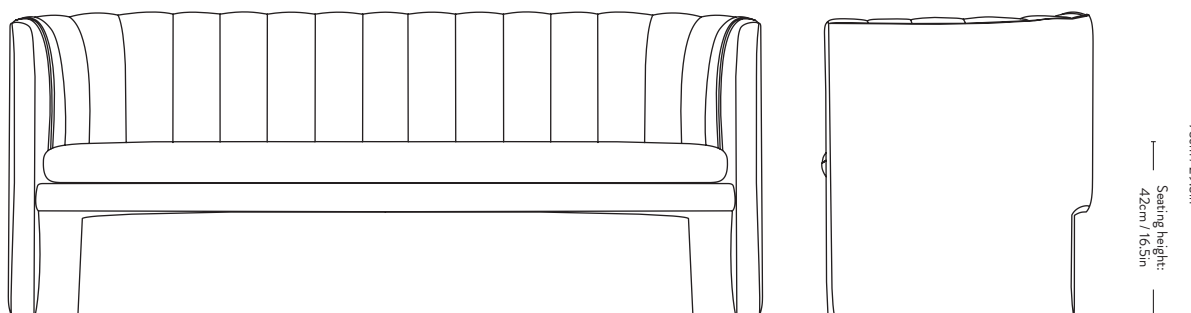

Inland ^{AV21} Anderssen & Voll 2023



Item no.	Upholstery	Base	Model	Lead time	Weight	PRICE EX. VAT (SEK)	PRICE INC. VAT (SEK)
12100300	Noble Aniline leather Cognac	Warm Black	AV21	Stock item	48 kg	35.816	44.770
Price gr.	Upholstery	Base	Model	Lead time	Weight	PRICE EX. VAT (SEK)	PRICE INC. VAT (SEK)
Fabric gr. 1	Hot Madison, Remix, Re-Wool	Warm Black Polished aluminium	AV21	6-8 weeks 6-8 weeks	48 kg	21.488	26.860
Fabric gr. 2	Canvas, Barnum, Fiord	Warm Black Polished aluminium	AV21	6-8 weeks 6-8 weeks	48 kg	23.876	29.845
Fabric gr. 3	Clay, Hallingdal, Steelcut Quartet, Steelcut Trio	Warm Black Polished aluminium	AV21	6-8 weeks 6-8 weeks	48 kg	24.472	30.590
Fabric gr. 4	Acca, Cifrado, Ecriture, Moss, Uniform Melange, Vidar	Warm Black Polished aluminium	AV21	6-8 weeks 6-8 weeks	48 kg	27.456	34.320
Fabric gr. 5	Karakorum, Sisu	Warm Black Polished aluminium	AV21	6-8 weeks 6-8 weeks	48 kg	35.816	44.770
Fabric gr. 6	Fuse, Gentle	Warm Black Polished aluminium	AV21	6-8 weeks 6-8 weeks	48 kg	39.396	49.245
Leather	Noble Aniline leather	Warm Black Polished aluminium	AV21	6-8 weeks 6-8 weeks	48 kg	35.816	44.770
Leather	Elmosoft Semi-aniline leather	Warm Black Polished aluminium	AV21	6-8 weeks 6-8 weeks	48 kg	38.204	47.755
COM	COM Fabric	Warm Black Polished aluminium	AV21	6-8 weeks 6-8 weeks	48 kg	21.488	26.860

Material: Wood, steel base, HR foam, polyester wadding, fabric upholstery.

Fabric usage: 6.1 meters based on 140cm roll.

Leather usage: 10.8 square meters based on a yield of 60% pr hide.

COM must be approved by &Tradition to ensure suitability for upholstery. Felt gliders installed as standard.

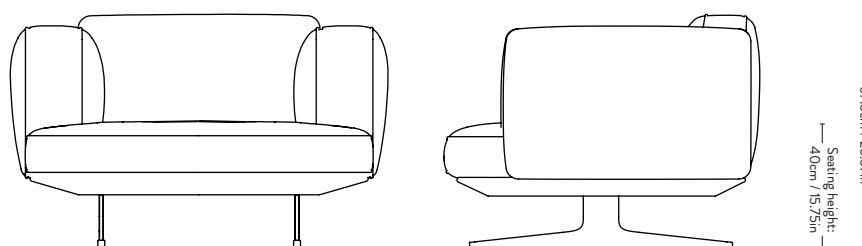

Inland AV22

Anderssen & Voll

2022

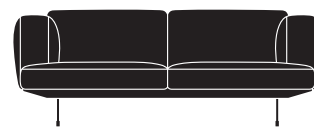

Item no.	Upholstery	Base	Model	Lead time	Weight	PRICE EX. VAT (SEK)	PRICE INC. VAT (SEK)
12200300	Noble Aniline leather Cognac	Warm Black	AV22	Stock item	78.0 kg	47.756	59.695
Price gr.	Upholstery	Base	Model	Lead time	Weight	PRICE EX. VAT (SEK)	PRICE INC. VAT (SEK)
Fabric gr. 1	Hot Madison, Remix, Re-Wool	Warm Black Polished aluminium	AV22	6-8 weeks 6-8 weeks	78.0 kg	29.844	37.305
Fabric gr. 2	Canvas, Barnum, Fiord	Warm Black Polished aluminium	AV22	6-8 weeks 6-8 weeks	78.0 kg	32.232	40.290
Fabric gr. 3	Clay, Hallingdal, Steelcut Quartet, Steelcut Trio	Warm Black Polished aluminium	AV22	6-8 weeks 6-8 weeks	78.0 kg	33.428	41.785
Fabric gr. 4	Acca, Cifrado, Ecriture, Moss, Uniform Melange, Vidar	Warm Black Polished aluminium	AV22	6-8 weeks 6-8 weeks	78.0 kg	35.816	44.770
Fabric gr. 5	Karakorum, Sisu	Warm Black Polished aluminium	AV22	6-8 weeks 6-8 weeks	78.0 kg	45.368	56.710
Fabric gr. 6	Fuse, Gentle	Warm Black Polished aluminium	AV22	6-8 weeks 6-8 weeks	78.0 kg	50.144	62.680
Leather	Noble Aniline leather	Warm Black Polished aluminium	AV22	6-8 weeks 6-8 weeks	78.0 kg	47.756	59.695
Leather	Elmosoft Semi-aniline leather	Warm Black Polished aluminium	AV22	6-8 weeks 6-8 weeks	78.0 kg	53.724	67.155
COM	COM Fabric	Warm Black Polished aluminium	AV22	6-8 weeks 6-8 weeks	78.0 kg	29.844	37.305

Material: Wood, steel base, HR foam, polyester wadding, fabric upholstery.

Fabric usage: 7.9 meters based on 140cm roll.

Leather usage: 19.8 square meters based on a yield of 60% pr hide.

COM must be approved by &Tradition to ensure suitability for upholstery. Felt gliders installed as standard.

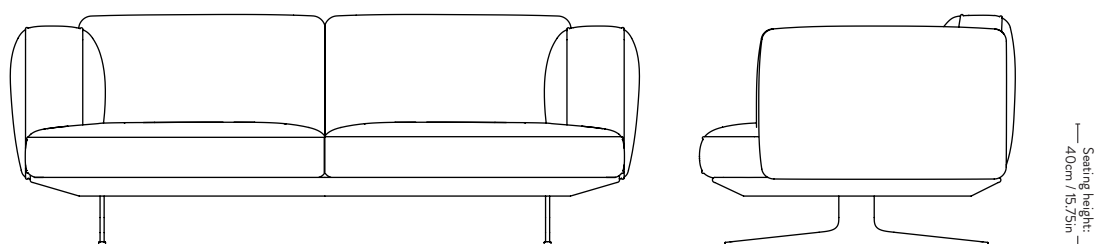

Inland AV23

Anderssen & Voll

2022



Item no.	Upholstery	Base	Model	Lead time	Weight	PRICE EX. VAT (SEK)	PRICE INC. VAT (SEK)
12300300	Noble Aniline leather Cognac	Warm Black	AV23	Stock item	92.0 kg	53.724	67.155
Price gr.	Upholstery	Base	Model	Lead time	Weight	PRICE EX. VAT (SEK)	PRICE INC. VAT (SEK)
Fabric gr. 1	Hot Madison, Remix, Re-Wool	Warm Black Polished aluminium	AV23	6-8 weeks 6-8 weeks	92.0 kg	35.816	44.770
Fabric gr. 2	Canvas, Barnum, Fiord	Warm Black Polished aluminium	AV23	6-8 weeks 6-8 weeks	92.0 kg	38.204	47.755
Fabric gr. 3	Clay, Hallingdal, Steelcut Quartet, Steelcut Trio	Warm Black Polished aluminium	AV23	6-8 weeks 6-8 weeks	92.0 kg	39.396	49.245
Fabric gr. 4	Acca, Cifrado, Ecriture, Moss, Uniform Melange, Vidar	Warm Black Polished aluminium	AV23	6-8 weeks 6-8 weeks	92.0 kg	41.784	52.230
Fabric gr. 5	Karakorum, Sisu	Warm Black Polished aluminium	AV23	6-8 weeks 6-8 weeks	92.0 kg	53.724	67.155
Fabric gr. 6	Fuse, Gentle	Warm Black Polished aluminium	AV23	6-8 weeks 6-8 weeks	92.0 kg	59.696	74.620
Leather	Noble Aniline leather	Warm Black Polished aluminium	AV23	6-8 weeks 6-8 weeks	92.0 kg	53.724	67.155
Leather	Elmosoft Semi-aniline leather	Warm Black Polished aluminium	AV23	6-8 weeks 6-8 weeks	92.0 kg	59.696	74.620
COM	COM Fabric	Warm Black Polished aluminium	AV23	6-8 weeks 6-8 weeks	92.0 kg	35.816	44.770

Material: Wood, steel base, HR foam, polyester wadding, fabric upholstery.

Fabric usage: 9.8 meters based on 140cm roll.

Leather usage: 25.3 square meters based on a yield of 60% pr hide.

COM must be approved by &Tradition to ensure suitability for upholstery.

Felt gliders installed as standard.

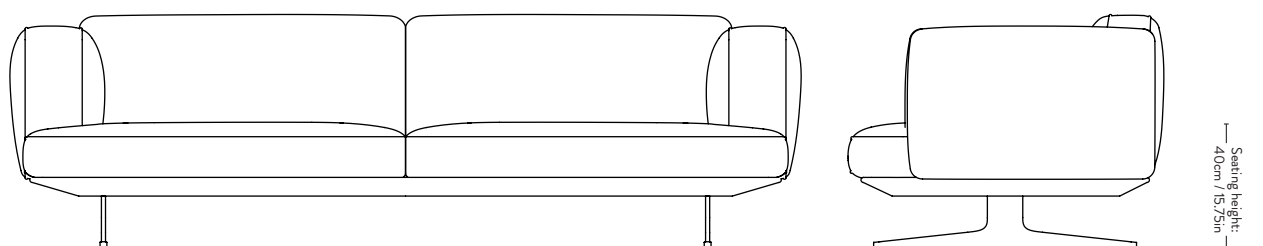

228cm / 89.76in

95.5cm / 37.60in

Seating depth: 40cm / 15.75in

Inland ^{AV32} Anderssen & Voll 2023



Price gr.	Upholstery	Base	Model	Lead time	Weight	PRICE EX. VAT (SEK)	PRICE INC. VAT (SEK)
Fabric gr. 1	Hot Madison, Remix, Re-Wool	Warm Black Polished aluminium	AV32	6-8 weeks 6-8 weeks	29 kg	11.936	14.920
Fabric gr. 2	Canvas, Barnum, Fiord	Warm Black Polished aluminium	AV32	6-8 weeks 6-8 weeks	29 kg	14.324	17.905
Fabric gr. 3	Clay, Hallingdal, Steelcut Quartet, Steelcut Trio	Warm Black Polished aluminium	AV32	6-8 weeks 6-8 weeks	29 kg	14.920	18.650
Fabric gr. 4	Acca, Cifrado, Ecriture, Moss, Uniform Melange, Vidar	Warm Black Polished aluminium	AV32	6-8 weeks 6-8 weeks	29 kg	17.904	22.380
Fabric gr. 5	Karakorum, Sisu	Warm Black Polished aluminium	AV32	6-8 weeks 6-8 weeks	29 kg	21.488	26.860
Fabric gr. 6	Fuse, Gentle	Warm Black Polished aluminium	AV32	6-8 weeks 6-8 weeks	29 kg	23.876	29.845
Leather	Noble Aniline leather	Warm Black Polished aluminium	AV32	6-8 weeks 6-8 weeks	29 kg	20.292	25.365
Leather	Elmosoft Semi-aniline leather	Warm Black Polished aluminium	AV32	6-8 weeks 6-8 weeks	29 kg	22.680	28.350
COM	COM Fabric	Warm Black Polished aluminium	AV32	6-8 weeks 6-8 weeks	29 kg	11.936	14.920

Material: Wood, steel base, HR foam, polyester wadding, fabric upholstery.

Fabric usage: 3.6 meters based on 140cm roll.

Leather usage: 4.3 square meters based on a yield of 60% pr hide.

COM must be approved by &Tradition to ensure suitability for upholstery. Felt gliders installed as standard.

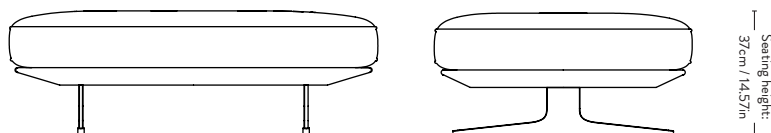

Mayor ^{AJ5}

Arne Jacobsen & Flemming Lassen

1939



Price gr.	Upholstery	Model	Base	Lead time	Weight	PRICE EX. VAT (SEK)	PRICE INC. VAT (SEK)
Fabric gr. 1	Hot Madison, Remix, Re-Wool	AJ5	Oak	6-8 weeks	45.00 kg	44.172	55.215
		AJ5	Walnut	6-8 weeks	45.00 kg	50.144	62.680
Fabric gr. 2	Canvas, Barnum, Fiord, Ritz	AJ5	Oak	6-8 weeks	45.00 kg	47.756	59.695
		AJ5	Walnut	6-8 weeks	45.00 kg	53.724	67.155
Fabric gr. 3	Clay, Hallingdal, Steelcut Quartet, Steelcut Trio	AJ5	Oak	6-8 weeks	45.00 kg	48.948	61.185
		AJ5	Walnut	6-8 weeks	45.00 kg	54.920	68.650
Fabric gr. 4	Acca, Cifrado, Ecriture, Moss, Uniform Melange, Vidar	AJ5	Oak	6-8 weeks	45.00 kg	51.336	64.170
		AJ5	Walnut	6-8 weeks	45.00 kg	57.308	71.635
Fabric gr. 5	Karakorum, Sisu	AJ5	Oak	6-8 weeks	45.00 kg	59.696	74.620
		AJ5	Walnut	6-8 weeks	45.00 kg	65.664	82.080
Fabric gr. 6	Fuse, Gentle	AJ5	Oak	6-8 weeks	45.00 kg	65.664	82.080
		AJ5	Walnut	6-8 weeks	45.00 kg	72.232	90.290
Leather	Noble Aniline leather	AJ5	Oak	6-8 weeks	45.00 kg	71.636	89.545
		AJ5	Walnut	6-8 weeks	45.00 kg	77.604	97.005
Leather	Elmosoft Semi-aniline leather	AJ5	Oak	6-8 weeks	45.00 kg	85.964	107.455
		AJ5	Walnut	6-8 weeks	45.00 kg	91.936	114.920
Sheepskin	Sheepskin 17mm (Moonlight & Sahara)	AJ5	Oak	6-8 weeks	45.00 kg	85.964	107.455
		AJ5	Walnut	6-8 weeks	45.00 kg	91.936	114.920
Fabric COM	COM Fabric	AJ5	Oak	6-8 weeks	45.00 kg	44.172	55.215
		AJ5	Walnut	6-8 weeks	45.00 kg	50.144	62.680

Item no.	Add on	Lead time	Weight	PRICE EX. VAT (SEK)	PRICE INC. VAT (SEK)
101015	Mayor high legs - legs providing a seating height of 47cm. *must be specified with the order	9-10 weeks	0.10 kg	2.980	3.725
101016	Piping & buttons in Noble Aniline leather. *must be specified with the order	6-8 weeks		6.560	8.200

As with most natural materials, differences in structure, density and thickness are expected, as two pieces of sheepskin never look identical and tend to show natural variations in both curls and tones.

COM must be approved by &Tradition to ensure suitability for upholstery. Felt gliders installed as standard.

Fabric usage: 6.5 meters based on 140cm roll.

Leather usage: 12 square meters based on a yield of 60% pr hide.

Base	Finish
Solid Oak	Oiled Oak, Smoked Oiled Oak, Black Water Based Lacquered Oak
Solid Walnut	Oiled Walnut

Material: Solid oak or walnut base, solid beech frame, elastic belts and HR foam. Fabric or leather upholstery.

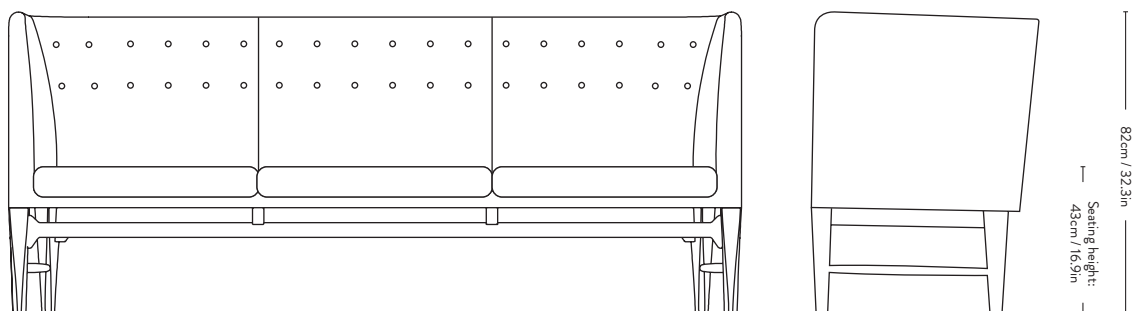

Mayor ^{AJ6}

Arne Jacobsen & Flemming Lassen

1939

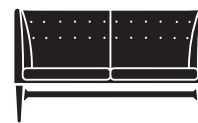

Price gr.	Upholstery	Model	Base	Lead time	Weight	PRICE EX. VAT (SEK)	PRICE INC. VAT (SEK)
Fabric gr. 1	Hot Madison, Remix, Re-Wool	AJ6	Oak	6-8 weeks	38.00 kg	39.396	49.245
		AJ6	Walnut	6-8 weeks	38.00 kg	44.172	55.215
Fabric gr. 2	Canvas, Barnum, Fiord, Ritz	AJ6	Oak	6-8 weeks	38.00 kg	42.980	53.725
		AJ6	Walnut	6-8 weeks	38.00 kg	47.756	59.695
Fabric gr. 3	Clay, Hallingdal, Steelcut Quartet, Steelcut Trio	AJ6	Oak	6-8 weeks	38.00 kg	44.172	55.215
		AJ6	Walnut	6-8 weeks	38.00 kg	48.948	61.185
Fabric gr. 4	Acca, Cifrado, Ecriture , Moss, Uniform Melange, Vidar	AJ6	Oak	6-8 weeks	38.00 kg	46.560	58.200
		AJ6	Walnut	6-8 weeks	38.00 kg	51.336	64.170
Fabric gr. 5	Karakorum, Sisu	AJ6	Oak	6-8 weeks	38.00 kg	52.532	65.665
		AJ6	Walnut	6-8 weeks	38.00 kg	57.308	71.635
Fabric gr. 6	Fuse, Gentle	AJ6	Oak	6-8 weeks	38.00 kg	57.904	72.380
		AJ6	Walnut	6-8 weeks	38.00 kg	63.276	79.095
Leather	Noble Aniline leather	AJ6	Oak	6-8 weeks	38.00 kg	60.888	76.110
		AJ6	Walnut	6-8 weeks	38.00 kg	65.664	82.080
Leather	Elmosoft Semi-aniline leather	AJ6	Oak	6-8 weeks	38.00 kg	74.024	92.530
		AJ6	Walnut	6-8 weeks	38.00 kg	78.800	98.500
Sheepskin	Sheepskin 17mm (Moonlight & Sahara)	AJ6	Oak	6-8 weeks	38.00 kg	74.024	92.530
		AJ6	Walnut	6-8 weeks	38.00 kg	78.800	98.500
Fabric COM	COM Fabric	AJ6	Oak	6-8 weeks	38.00 kg	39.396	49.245
		AJ6	Walnut	6-8 weeks	38.00 kg	44.172	55.215

Item no.	Add on	Lead time	Weight	PRICE EX. VAT (SEK)	PRICE INC. VAT (SEK)
101015	Mayor high legs - legs providing a seating height of 47cm. *must be specified with the order	9-10 weeks	0.10 kg	2.980	3.725
101016	Piping & buttons in Noble Aniline leather. *must be specified with the order	6-8 weeks		6.560	8.200

As with most natural materials, differences in structure, density and thickness are expected, as two pieces of sheepskin never look identical and tend to show natural variations in both curls and tones.

COM must be approved by &Tradition to ensure suitability for upholstery.
Felt gliders installed as standard.

Fabric usage: 5 meters based on 140cm roll.

Leather usage: 10 square meters based on a yield of 60% pr hide.

Base	Finish
Solid Oak	Oiled Oak, Smoked Oiled Oak, Black Water Based Lacquered Oak
Solid Walnut	Oiled Walnut

Material: Solid oak or walnut base, solid beech frame, elastic belts and HR foam.
Fabric or leather upholstery.

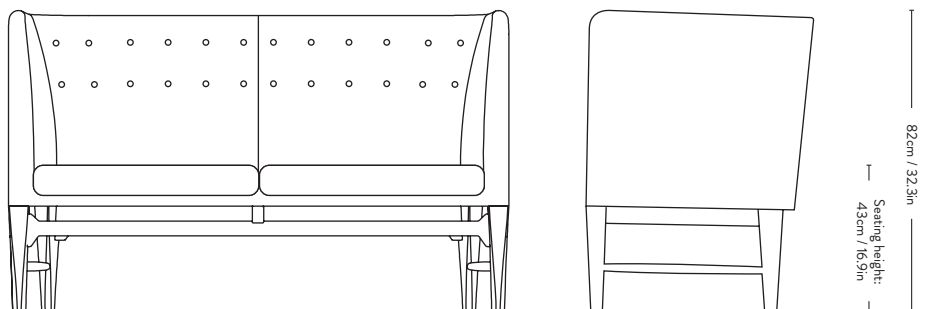

Cloud^{LN1}

Luca Nichetto

2015



Price gr.	Upholstery	Model	Base	Lead time	Weight	PRICE EX. VAT (SEK)	PRICE INC. VAT (SEK)
Fabric gr. 1	Hot Madison, Remix, Re-Wool	LN1	Warm Black or Chrome	6-8 weeks	40.00 kg	25.068	31.335
Fabric gr. 2	Canvas, Barnum, Fiord, Ritz	LN1	Warm Black or Chrome	6-8 weeks	40.00 kg	28.652	35.815
Fabric gr. 3	Clay, Hallingdal, Steelcut Quartet, Steelcut Trio	LN1	Warm Black or Chrome	6-8 weeks	40.00 kg	29.248	36.560
Fabric gr. 4	Acca, Cifrado, Ecriture, Moss, Uniform Melange, Vidar	LN1	Warm Black or Chrome	6-8 weeks	40.00 kg	31.040	38.800
Fabric gr. 5	Karakorum, Sisu	LN1	Warm Black or Chrome	6-8 weeks	40.00 kg	38.204	47.755
Fabric gr. 6	Fuse, Gentle	LN1	Warm Black or Chrome	6-8 weeks	40.00 kg	41.784	52.230
Leather	Noble Aniline leather	LN1	Warm Black or Chrome	6-8 weeks	40.00 kg	46.560	58.200
Leather	Elmosoft Semi-aniline leather	LN1	Warm Black or Chrome	6-8 weeks	40.00 kg	56.112	70.140
Fabric COM	COM Fabric	LN1	Warm Black or Chrome	6-8 weeks	40.00 kg	25.068	31.335

Legs Finish

Solid	Powder Coated Warm Black
Steel tube	Chrome

Material: Plywood, solid wood and steel base with no-zag springs. HR foam, polyester fibers and feather pillows. Solid steel legs. Fabric or leather upholstery.

Fabric usage: 6 meters based on 140cm roll.

Leather usage: 14 square meters based on a yield of 60% pr hide.

COM must be approved by &Tradition to ensure suitability for upholstery.

Felt gliders installed as standard.

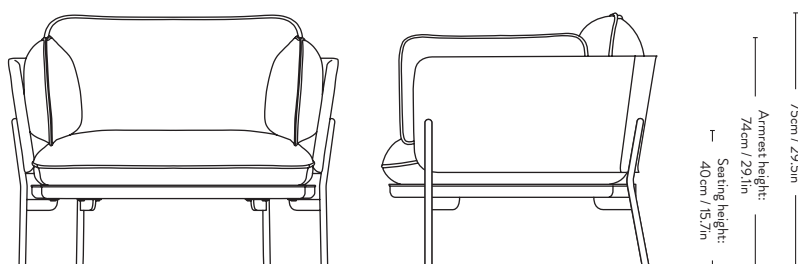

Cloud LN2

Luca Nichetto

2015



Price gr.	Upholstery	Model	Base	Lead time	Weight	PRICE EX. VAT (SEK)	PRICE INC. VAT (SEK)
Fabric gr. 1	Hot Madison, Remix, Re-Wool	LN2	Warm Black or Chrome	6-8 weeks	57.00 kg	33.428	41.785
Fabric gr. 2	Canvas, Barnum, Fiord, Ritz	LN2	Warm Black or Chrome	6-8 weeks	57.00 kg	38.204	47.755
Fabric gr. 3	Clay, Hallingdal, Steelcut Quartet, Steelcut Trio	LN2	Warm Black or Chrome	6-8 weeks	57.00 kg	39.396	49.245
Fabric gr. 4	Acca, Cifrado, Ecriture, Moss, Uniform Melange, Vidar	LN2	Warm Black or Chrome	6-8 weeks	57.00 kg	40.592	50.740
Fabric gr. 5	Karakorum, Sisu	LN2	Warm Black or Chrome	6-8 weeks	57.00 kg	54.324	67.905
Fabric gr. 6	Fuse, Gentle	LN2	Warm Black or Chrome	6-8 weeks	57.00 kg	59.696	74.620
Leather	Noble Aniline leather	LN2	Warm Black or Chrome	6-8 weeks	57.00 kg	62.680	78.350
Leather	Elmosoft Semi-aniline leather	LN2	Warm Black or Chrome	6-8 weeks	57.00 kg	75.216	94.020
Fabric COM	COM Fabric	LN2	Warm Black or Chrome	6-8 weeks	57.00 kg	33.428	41.785

Legs Finish

Solid	Powder Coated Warm Black
Steel tube	Chrome

Material: Plywood, solid wood and steel base with no-zag springs. HR foam, polyester fibers and feather pillows. Solid steel legs. Fabric or leather upholstery.

Fabric usage: 8 meters based on 140cm roll.

Leather usage: 19 square meters based on a yield of 60% pr hide.

COM must be approved by Tradition to ensure suitability for upholstery.

Felt gliders installed as standard.

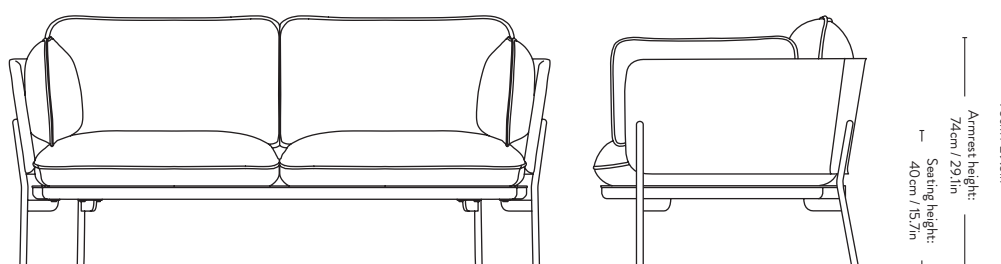

Cloud LN3.2

Luca Nichetto

2015

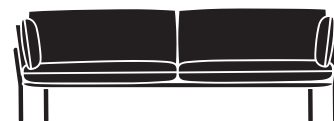

Price gr.	Upholstery	Model	Base	Lead time	Weight	PRICE EX. VAT (SEK)	PRICE INC. VAT (SEK)
Fabric gr. 1	Hot Madison, Remix, Re-Wool	LN3.2	Warm Black or Chrome	6-8 weeks	69.00 kg	39.996	49.995
Fabric gr. 2	Canvas, Barnum, Fiord, Ritz	LN3.2	Warm Black or Chrome	6-8 weeks	69.00 kg	45.368	56.710
Fabric gr. 3	Clay, Hallingdal, Steelcut Quartet, Steelcut Trio	LN3.2	Warm Black or Chrome	6-8 weeks	69.00 kg	46.560	58.200
Fabric gr. 4	Acca, Cifrado, Ecriture, Moss, Uniform Melange, Vidar	LN3.2	Warm Black or Chrome	6-8 weeks	69.00 kg	49.548	61.935
Fabric gr. 5	Karakorum, Sisu	LN3.2	Warm Black or Chrome	6-8 weeks	69.00 kg	65.664	82.080
Fabric gr. 6	Fuse, Gentle	LN3.2	Warm Black or Chrome	6-8 weeks	69.00 kg	72.232	90.290
Leather	Noble Aniline leather	LN3.2	Warm Black or Chrome	6-8 weeks	69.00 kg	69.248	86.560
Leather	Elmosoft Semi-aniline leather	LN3.2	Warm Black or Chrome	6-8 weeks	69.00 kg	83.576	104.470
Fabric COM	COM Fabric	LN3.2	Warm Black or Chrome	6-8 weeks	69.00 kg	39.996	49.995

Legs Finish

Solid	Powder Coated Warm Black
Steel tube	Chrome

Material: Plywood, solid wood and steel base with no-zag springs. HR foam, polyester fibers and feather pillows. Solid steel legs. Fabric or leather upholstery.

Fabric usage: 11 meters based on 140cm roll.

Leather usage: 21 square meters based on a yield of 60% pr hide.

COM must be approved by &Tradition to ensure suitability for upholstery.

Felt gliders installed as standard.

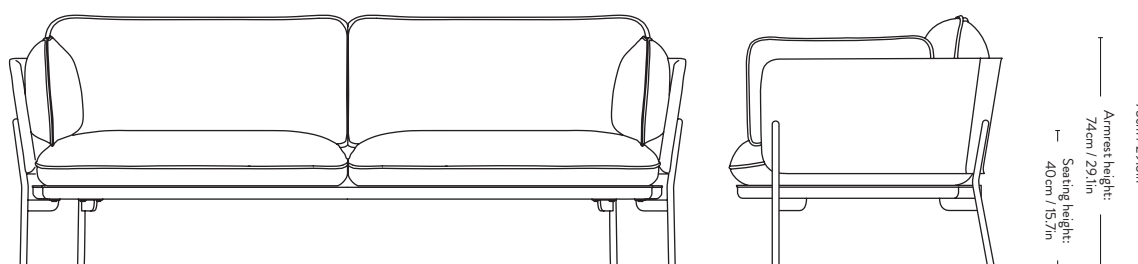

220cm / 86.6in

84cm / 33in

Seating depth: 64cm / 25.2in

22% RABATT SKA DRAS AV PÅ ANGIVNA PRISER

Cloud^{LN5}

Luca Nichetto

2018



Price gr.	Upholstery	Model	Base	Lead time	Weight	PRICE EX. VAT (SEK)	PRICE INC. VAT (SEK)
Fabric gr. 1	Hot Madison, Remix, Re-Wool	LN5	Warm Black or Chrome	6-8 weeks	50.00 kg	33.428	41.785
Fabric gr. 2	Canvas, Barnum, Fiord, Ritz	LN5	Warm Black or Chrome	6-8 weeks	50.00 kg	39.396	49.245
Fabric gr. 3	Clay, Hallingdal, Steelcut Quartet, Steelcut Trio	LN5	Warm Black or Chrome	6-8 weeks	50.00 kg	39.996	49.995
Fabric gr. 4	Acca, Cifrado, Ecriture, Moss, Uniform Melange, Vidar	LN5	Warm Black or Chrome	6-8 weeks	50.00 kg	44.172	55.215
Fabric gr. 5	Karakorum, Sisu	LN5	Warm Black or Chrome	6-8 weeks	50.00 kg	65.664	82.080
Fabric gr. 6	Fuse, Gentle	LN5	Warm Black or Chrome	6-8 weeks	50.00 kg	71.636	89.545
Leather	Noble Aniline leather	LN5	Warm Black or Chrome	6-8 weeks	50.00 kg	54.920	68.650
Fabric COM	COM Fabric	LN5	Warm Black or Chrome	6-8 weeks	50.00 kg	33.428	41.785

Item no.	Add on	Lead time	Weight	PRICE EX. VAT (DKK)	PRICE INC. VAT (DKK)
30310001	Power outlet incl bracket (DK plug) *must be specified with the order	6-8 weeks		2.980	3.725

Legs	Finish
Solid	Powder Coated Warm Black
Steel tube	Chrome

Material: Plywood, solid wood and steel base with no-zag springs. HR foam, polyester fibers and feather pillows. Solid steel legs. Fabric or leather upholstery.

Fabric usage: 12 meters based on 140cm roll.

COM must be approved by Tradition to ensure suitability for upholstery.

Felt gliders installed as standard.

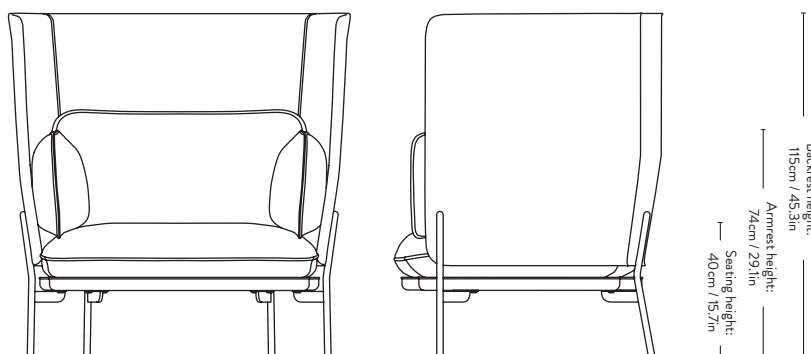

Cloud LN6

Luca Nichetto

2017

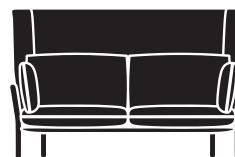

Price gr.	Upholstery	Model	Base	Lead time	Weight	PRICE EX. VAT (SEK)	PRICE INC. VAT (SEK)
Fabric gr. 1	Hot Madison, Remix, Re-Wool	LN6	Warm Black or Chrome	6-8 weeks	71.00 kg	42.980	53.725
Fabric gr. 2	Canvas, Barnum, Fiord, Ritz	LN6	Warm Black or Chrome	6-8 weeks	71.00 kg	48.948	61.185
Fabric gr. 3	Clay, Hallingdal, Steelcut Quartet, Steelcut Trio	LN6	Warm Black or Chrome	6-8 weeks	71.00 kg	50.144	62.680
Fabric gr. 4	Acca, Cifrado, Ecriture, Moss, Uniform Melange, Vidar	LN6	Warm Black or Chrome	6-8 weeks	71.00 kg	54.920	68.650
Fabric gr. 5	Karakorum, Sisu	LN6	Warm Black or Chrome	6-8 weeks	71.00 kg	78.800	98.500
Fabric gr. 6	Fuse, Gentle	LN6	Warm Black or Chrome	6-8 weeks	71.00 kg	86.560	108.200
Leather	Noble Aniline leather	LN6	Warm Black or Chrome	6-8 weeks	71.00 kg	68.052	85.065
Fabric COM	COM Fabric	LN6	Warm Black or Chrome	6-8 weeks	71.00 kg	42.980	53.725

Item no.	Add on	Lead time	Weight	PRICE EX. VAT (SEK)	PRICE INC. VAT (SEK)
30310001	Power outlet incl bracket (DK plug) *must be specified with the order	6-8 weeks		2.980	3.725

Legs Finish

Solid	Powder Coated Warm Black
Steel tube	Chrome

Material: Plywood, solid wood and steel base with no-zag springs. HR foam, polyester fibers and feather pillows. Solid steel legs. Fabric or leather upholstery.

Fabric usage: 17 meters based on 140cm roll.

COM must be approved by &Tradition to ensure suitability for upholstery.

Cloud LN6 is not available in COL leather.

Felt gliders installed as standard.

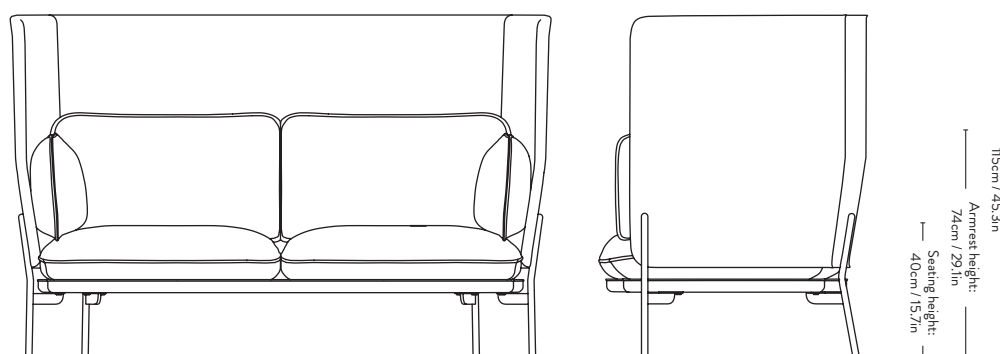

Cloud LN7

Luca Nichetto

2017

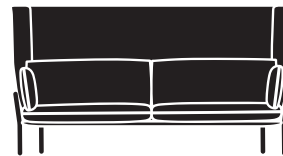

Price gr.	Upholstery	Model	Base	Lead time	Weight	PRICE EX. VAT (SEK)	PRICE INC. VAT (SEK)
Fabric gr. 1	Hot Madison, Remix, Re-Wool	LN7	Warm Black or Chrome	6-8 weeks	85.00 kg	48.948	61.185
Fabric gr. 2	Canvas, Barnum, Fiord, Ritz	LN7	Warm Black or Chrome	6-8 weeks	85.00 kg	56.112	70.140
Fabric gr. 3	Clay, Hallingdal, Steelcut Quartet, Steelcut Trio	LN7	Warm Black or Chrome	6-8 weeks	85.00 kg	57.308	71.635
Fabric gr. 4	Acca, Cifrado, Ecriture, Moss, Uniform Melange, Vidar	LN7	Warm Black or Chrome	6-8 weeks	85.00 kg	64.472	80.590
Fabric gr. 5	Karakorum, Sisu	LN7	Warm Black or Chrome	6-8 weeks	85.00 kg	95.516	119.395
Fabric gr. 6	Fuse, Gentle	LN7	Warm Black or Chrome	6-8 weeks	85.00 kg	105.068	131.335
Leather	Noble Aniline leather	LN7	Warm Black or Chrome	6-8 weeks	85.00 kg	79.996	99.995
Fabric COM	COM Fabric	LN7	Warm Black or Chrome	6-8 weeks	85.00 kg	48.948	61.185

Item no.	Add on	Lead time	Weight	PRICE EX. VAT (SEK)	PRICE INC. VAT (SEK)
30310001	Power outlet incl bracket (DK plug) *must be specified with the order	6-8 weeks		2.980	3.725

Legs

Finish

Solid Powder Coated Warm Black
Steel tube Chrome

Material: Plywood, solid wood and steel base with no-zag springs. HR foam, polyester fibers and feather pillows. Solid steel legs. Fabric or leather upholstery.

Fabric usage: 18 meters based on 140cm roll.

COM must be approved by &Tradition to ensure suitability for upholstery.

Cloud LN7 is not available in COL leather.

Felt gliders installed as standard.

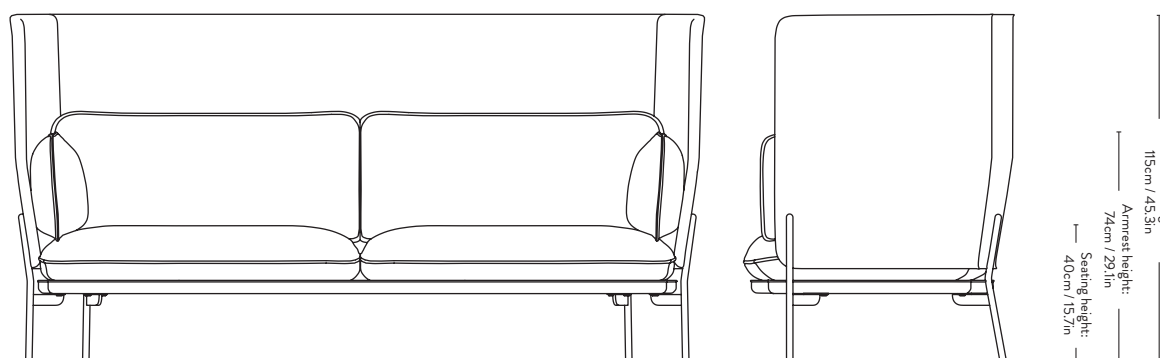

Develius ^{EV1-EV7} Edward van Vliet 2018



EV1 modules:

Seating Depth: 64cm / 25.2in, Seating Height: 42cm / 16.5in, Armrest Height: 60cm / 23.6in, Backrest Height: 70cm / 27.6in

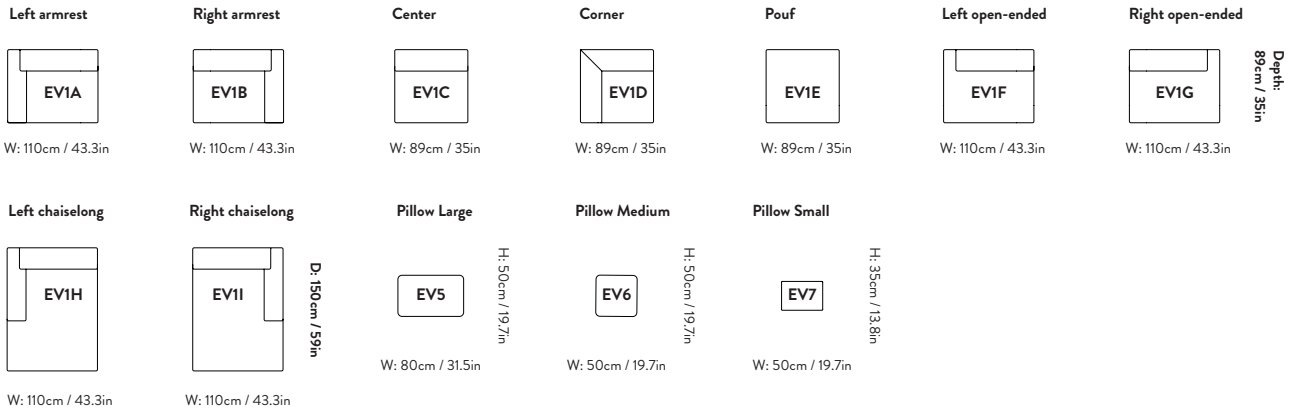

EV2 modules:

Seating Depth: 85cm / 33.5in, Seating Height: 42cm / 16.5in, Armrest Height: 60cm / 23.6in, Backrest Height: 70cm / 27.6in

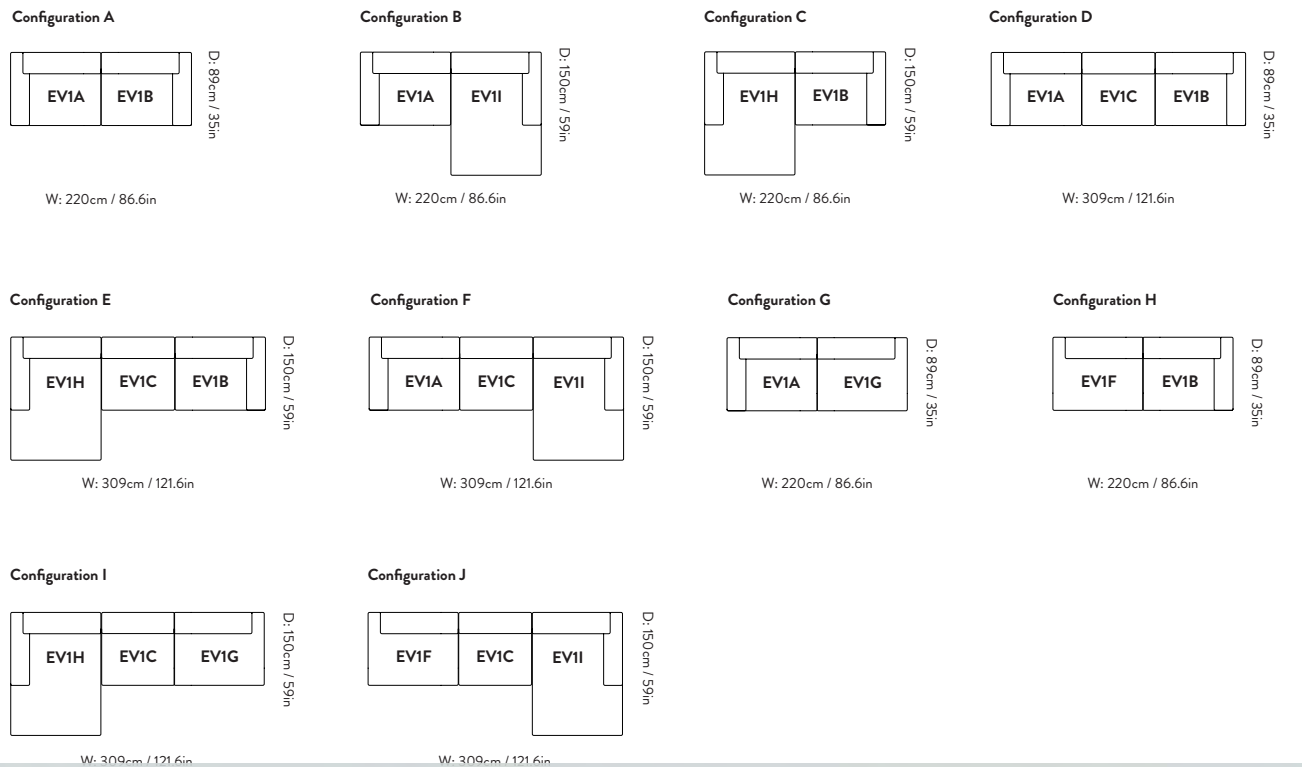
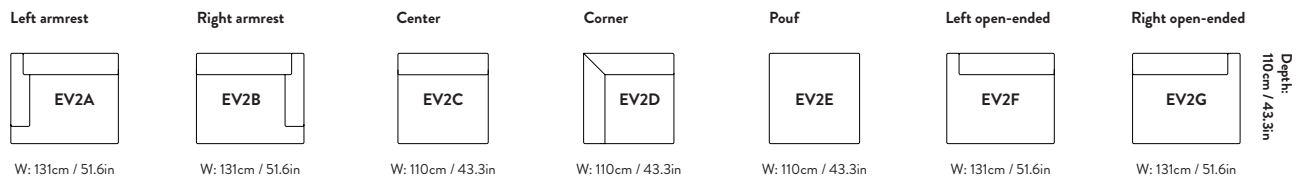

Develius

Edward van Vliet

2018

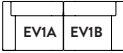
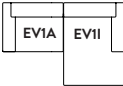
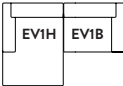
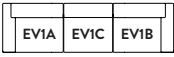
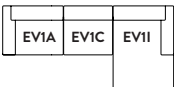

Item no.	Model	Upholstery	Lead time	PRICE EX. VAT (SEK)	PRICE INC. VAT (SEK)
70341001	Configuration A	Hot Madison 094	2-4 weeks	28.644	35.805
70361001		Clay 0003	2-4 weeks	32.228	40.285
70381001		Hallingdal 220	2-4 weeks	32.228	40.285
70341002	Configuration B	Hot Madison 094	2-4 weeks	32.824	41.030
70361002		Clay 0003	2-4 weeks	36.404	45.505
70381002		Hallingdal 220	2-4 weeks	36.404	45.505
70341003	Configuration C	Hot Madison 094	2-4 weeks	32.824	41.030
70361003		Clay 0003	2-4 weeks	36.404	45.505
70381003		Hallingdal 220	2-4 weeks	36.404	45.505
70341004	Configuration D	Hot Madison 094	2-4 weeks	40.580	50.725
70361004		Clay 0003	2-4 weeks	45.952	57.440
70381004		Hallingdal 220	2-4 weeks	45.952	57.440
70341005	Configuration E	Hot Madison 094	2-4 weeks	44.760	55.950
70361005		Clay 0003	2-4 weeks	50.132	62.665
70381005		Hallingdal 220	2-4 weeks	50.132	62.665
70341006	Configuration F	Hot Madison 094	2-4 weeks	44.760	55.950
70361006		Clay 0003	2-4 weeks	50.132	62.665
70381006		Hallingdal 220	2-4 weeks	50.132	62.665

Develius

Edward van Vliet

2018



Model	Product	Upholstery	Lead time	PRICE EX. VAT (SEK)	PRICE INC. VAT (SEK)
A	Configuration A 	• Hot Madison, Remix, Re-wool	6-8 weeks	28.644	35.805
		• Canvas, Barnum, Fiord, Ritz	6-8 weeks	31.032	38.790
		• Clay, Hallingdal, Steelcut Quartet, Steelcut Trio	6-8 weeks	32.228	40.285
		• Acca, Cifrado, Ecriture, Moss, Uniform Melange, Vidar	6-8 weeks	38.196	47.745
		• Karakorum, Sisu	6-8 weeks	57.300	71.625
		• Fuse, Gentle	6-8 weeks	63.272	79.090
		• Noble Aniline leather	6-8 weeks	54.912	68.640
• COM	6-8 weeks	28.644	35.805		
B	Configuration B 	• Hot Madison, Remix, Re-wool	6-8 weeks	32.824	41.030
		• Canvas, Barnum, Fiord, Ritz	6-8 weeks	35.212	44.015
		• Clay, Hallingdal, Steelcut Quartet, Steelcut Trio	6-8 weeks	36.404	45.505
		• Acca, Cifrado, Ecriture, Moss, Uniform Melange, Vidar	6-8 weeks	42.376	52.970
		• Karakorum, Sisu	6-8 weeks	62.676	78.345
		• Fuse, Gentle	6-8 weeks	69.240	86.550
		• Noble Aniline leather	6-8 weeks	61.480	76.850
• COM	6-8 weeks	32.824	41.030		
C	Configuration C 	• Hot Madison, Remix, Re-wool	6-8 weeks	32.824	41.030
		• Canvas, Barnum, Fiord, Ritz	6-8 weeks	35.212	44.015
		• Clay, Hallingdal, Steelcut Quartet, Steelcut Trio	6-8 weeks	36.404	45.505
		• Acca, Cifrado, Ecriture, Moss, Uniform Melange, Vidar	6-8 weeks	42.376	52.970
		• Karakorum, Sisu	6-8 weeks	62.676	78.345
		• Fuse, Gentle	6-8 weeks	69.240	86.550
		• Noble Aniline leather	6-8 weeks	61.480	76.850
• COM	6-8 weeks	32.824	41.030		
D	Configuration D 	• Hot Madison, Remix, Re-wool	6-8 weeks	40.580	50.725
		• Canvas, Barnum, Fiord, Ritz	6-8 weeks	44.160	55.200
		• Clay, Hallingdal, Steelcut Quartet, Steelcut Trio	6-8 weeks	45.952	57.440
		• Acca, Cifrado, Ecriture, Moss, Uniform Melange, Vidar	6-8 weeks	53.712	67.140
		• Karakorum, Sisu	6-8 weeks	79.984	99.980
		• Fuse, Gentle	6-8 weeks	88.340	110.425
		• Noble Aniline leather	6-8 weeks	76.400	95.500
• COM	6-8 weeks	40.580	50.725		
E	Configuration E 	• Hot Madison, Remix, Re-wool	6-8 weeks	44.760	55.950
		• Canvas, Barnum, Fiord, Ritz	6-8 weeks	48.340	60.425
		• Clay, Hallingdal, Steelcut Quartet, Steelcut Trio	6-8 weeks	50.132	62.665
		• Acca, Cifrado, Ecriture, Moss, Uniform Melange, Vidar	6-8 weeks	57.892	72.365
		• Karakorum, Sisu	6-8 weeks	85.356	106.695
		• Fuse, Gentle	6-8 weeks	94.312	117.890
		• Noble Aniline leather	6-8 weeks	82.968	103.710
• COM	6-8 weeks	44.760	55.950		
F	Configuration F 	• Hot Madison, Remix, Re-wool	6-8 weeks	44.760	55.950
		• Canvas, Barnum, Fiord, Ritz	6-8 weeks	48.340	60.425
		• Clay, Hallingdal, Steelcut Quartet, Steelcut Trio	6-8 weeks	50.132	62.665
		• Acca, Cifrado, Ecriture, Moss, Uniform Melange, Vidar	6-8 weeks	57.892	72.365
		• Karakorum, Sisu	6-8 weeks	85.356	106.695
		• Fuse, Gentle	6-8 weeks	94.312	117.890
		• Noble Aniline leather	6-8 weeks	82.968	103.710
• COM	6-8 weeks	44.760	55.950		
G	Configuration G 	• Hot Madison, Remix, Re-wool	6-8 weeks	28.048	35.060
		• Canvas, Barnum, Fiord, Ritz	6-8 weeks	30.436	38.045
		• Clay, Hallingdal, Steelcut Quartet, Steelcut Trio	6-8 weeks	31.628	39.535
		• Acca, Cifrado, Ecriture, Moss, Uniform Melange, Vidar	6-8 weeks	37.004	46.255
		• Karakorum, Sisu	6-8 weeks	54.316	67.895
		• Fuse, Gentle	6-8 weeks	60.288	75.360
		• Noble Aniline leather	6-8 weeks	53.720	67.150
• COM	6-8 weeks	28.048	35.060		

Develius

Edward van Vliet

2018

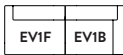
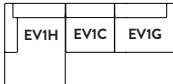
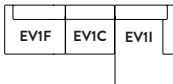

Model	Product	Upholstery	Lead time	PRICE EX.	PRICE INC.		
				VAT (SEK)	VAT (SEK)		
H	Configuration H 	• Hot Madison, Remix, Re-wool	6-8 weeks	28.048	35.060		
		• Canvas, Barnum, Fiord, Ritz	6-8 weeks	30.436	38.045		
		• Clay, Hallingdal, Steelcut Quartet, Steelcut Trio	6-8 weeks	31.628	39.535		
		• Acca, Cifrado, Ecriture, Moss, Uniform Melange, Vidar	6-8 weeks	37.004	46.255		
		• Karakorum, Sisu	6-8 weeks	54.316	67.895		
		• Fuse, Gentle	6-8 weeks	60.288	75.360		
		• Noble Aniline leather	6-8 weeks	53.720	67.150		
		• COM	6-8 weeks	28.048	35.060		
		I	Configuration I 	• Hot Madison, Remix, Re-wool	6-8 weeks	44.160	55.200
				• Canvas, Barnum, Fiord, Ritz	6-8 weeks	47.744	59.680
• Clay, Hallingdal, Steelcut Quartet, Steelcut Trio	6-8 weeks			49.536	61.920		
• Acca, Cifrado, Ecriture, Moss, Uniform Melange, Vidar	6-8 weeks			56.700	70.875		
• Karakorum, Sisu	6-8 weeks			82.372	102.965		
• Fuse, Gentle	6-8 weeks			91.324	114.155		
• Noble Aniline leather	6-8 weeks			81.772	102.215		
• COM	6-8 weeks			44.160	55.200		
J	Configuration J 			• Hot Madison, Remix, Re-wool	6-8 weeks	44.160	55.200
				• Canvas, Barnum, Fiord, Ritz	6-8 weeks	47.744	59.680
		• Clay, Hallingdal, Steelcut Quartet, Steelcut Trio	6-8 weeks	49.536	61.920		
		• Acca, Cifrado, Ecriture, Moss, Uniform Melange, Vidar	6-8 weeks	56.700	70.875		
		• Karakorum, Sisu	6-8 weeks	82.372	102.965		
		• Fuse, Gentle	6-8 weeks	91.324	114.155		
		• Noble Aniline leather	6-8 weeks	81.772	102.215		
		• COM	6-8 weeks	44.160	55.200		

Material: Wooden frame, no-zag springs, HR foam and polyester wadding. Metal brackets for connecting modules.



Felt gliders installed as standard.

Develius ^{EV1A-EV1I}

Edward van Vliet

2018



Model	Product	Upholstery	Lead time		PRICE EX. VAT (SEK)	PRICE INC. VAT (SEK)		
EV1H	Left chaiselong  Fabric usage: 6.1m* Leather consumption: 12.3 sqm*	• Hot Madison, Remix, Re-wool	6-8 weeks	70.00 kg	18.500	23.125		
		• Canvas, Barnum, Fiord, Ritz	6-8 weeks	70.00 kg	19.696	24.620		
		• Clay, Hallingdal, Steelcut Quartet, Steelcut Trio	6-8 weeks	70.00 kg	20.292	25.365		
		• Acca, Cifrado, Ecriture, Moss, Uniform Melange, Vidar	6-8 weeks	70.00 kg	23.276	29.095		
		• Karakorum, Sisu	6-8 weeks	70.00 kg	34.024	42.530		
		• Fuse, Gentle	6-8 weeks	70.00 kg	37.604	47.005		
		• Noble Aniline leather	6-8 weeks	70.00 kg	34.024	42.530		
		• COM	6-8 weeks	70.00 kg	18.500	23.125		
		EV1I	Right chaiselong  Fabric usage: 6.1m* Leather consumption: 12.3 sqm*	• Hot Madison, Remix, Re-wool	6-8 weeks	70.00 kg	18.500	23.125
				• Canvas, Barnum, Fiord, Ritz	6-8 weeks	70.00 kg	19.696	24.620
• Clay, Hallingdal, Steelcut Quartet, Steelcut Trio	6-8 weeks			70.00 kg	20.292	25.365		
• Acca, Cifrado, Ecriture, Moss, Uniform Melange, Vidar	6-8 weeks			70.00 kg	23.276	29.095		
• Karakorum, Sisu	6-8 weeks			70.00 kg	34.024	42.530		
• Fuse, Gentle	6-8 weeks			70.00 kg	37.604	47.005		
• Noble Aniline leather	6-8 weeks			70.00 kg	34.024	42.530		
• COM	6-8 weeks			70.00 kg	18.500	23.125		

Material: Wooden frame, no-zag springs, HR foam and polyester wadding. Metal brackets for connecting modules.

COM must be approved by &Tradition to ensure suitability for upholstery.







Felt gliders installed as standard.

Develius EV2A-EV2G

Edward van Vliet

2018



Model	Product	Upholstery	Lead time	Weight	PRICE EX. VAT (SEK)	PRICE INC. VAT (SEK)
EV2A	Left armrest 	• Hot Madison, Remix, Re-wool	6-8 weeks	63.00 kg	19.100	23.875
		• Canvas, Barnum, Fiord, Ritz	6-8 weeks	63.00 kg	21.488	26.860
		• Clay, Hallingdal, Steelcut Quartet, Steelcut Trio	6-8 weeks	63.00 kg	22.084	27.605
		• Acca, Cifrado, Ecriture, Moss, Uniform Melange, Vidar	6-8 weeks	63.00 kg	24.472	30.590
		• Karakorum, Sisu	6-8 weeks	63.00 kg	33.428	41.785
		• Fuse, Gentle	6-8 weeks	63.00 kg	37.008	46.260
	Fabric usage: 5.5m*	• COM	6-8 weeks	63.00 kg	19.100	23.875
EV2B	Right armrest 	• Hot Madison, Remix, Re-wool	6-8 weeks	63.00 kg	19.100	23.875
		• Canvas, Barnum, Fiord, Ritz	6-8 weeks	63.00 kg	21.488	26.860
		• Clay, Hallingdal, Steelcut Quartet, Steelcut Trio	6-8 weeks	63.00 kg	22.084	27.605
		• Acca, Cifrado, Ecriture, Moss, Uniform Melange, Vidar	6-8 weeks	63.00 kg	24.472	30.590
		• Karakorum, Sisu	6-8 weeks	63.00 kg	33.428	41.785
		• Fuse, Gentle	6-8 weeks	63.00 kg	37.008	46.260
	Fabric usage: 5.5m*	• COM	6-8 weeks	63.00 kg	19.100	23.875
EV2C	Center 	• Hot Madison, Remix, Re-wool	6-8 weeks	48.00 kg	15.516	19.395
		• Canvas, Barnum, Fiord, Ritz	6-8 weeks	48.00 kg	16.712	20.890
		• Clay, Hallingdal, Steelcut Quartet, Steelcut Trio	6-8 weeks	48.00 kg	17.308	21.635
		• Acca, Cifrado, Ecriture, Moss, Uniform Melange, Vidar	6-8 weeks	48.00 kg	19.100	23.875
		• Karakorum, Sisu	6-8 weeks	48.00 kg	26.264	32.830
		• Fuse, Gentle	6-8 weeks	48.00 kg	28.652	35.815
	Fabric usage: 4.4m*	• COM	6-8 weeks	48.00 kg	15.516	19.395
EV2D	Corner 	• Hot Madison, Remix, Re-wool	6-8 weeks	57.00 kg	17.308	21.635
		• Canvas, Barnum, Fiord, Ritz	6-8 weeks	57.00 kg	18.500	23.125
		• Clay, Hallingdal, Steelcut Quartet, Steelcut Trio	6-8 weeks	57.00 kg	19.100	23.875
		• Acca, Cifrado, Ecriture, Moss, Uniform Melange, Vidar	6-8 weeks	57.00 kg	22.084	27.605
		• Karakorum, Sisu	6-8 weeks	57.00 kg	31.636	39.545
		• Fuse, Gentle	6-8 weeks	57.00 kg	34.620	43.275
	Fabric usage: 5.7m*	• COM	6-8 weeks	57.00 kg	17.308	21.635
EV2E	Pouf 	• Hot Madison, Remix, Re-wool	6-8 weeks	32.00 kg	13.128	16.410
		• Canvas, Barnum, Fiord, Ritz	6-8 weeks	32.00 kg	14.324	17.905
		• Clay, Hallingdal, Steelcut Quartet, Steelcut Trio	6-8 weeks	32.00 kg	14.920	18.650
		• Acca, Cifrado, Ecriture, Moss, Uniform Melange, Vidar	6-8 weeks	32.00 kg	16.712	20.890
		• Karakorum, Sisu	6-8 weeks	32.00 kg	21.488	26.860
		• Fuse, Gentle	6-8 weeks	32.00 kg	23.876	29.845
	Fabric usage: 3.6m*	• COM	6-8 weeks	32.00 kg	13.128	16.410
EV2F	Left open-ended 	• Hot Madison, Remix, Re-wool	6-8 weeks	57.00 kg	18.500	23.125
		• Canvas, Barnum, Fiord, Ritz	6-8 weeks	57.00 kg	20.292	25.365
		• Clay, Hallingdal, Steelcut Quartet, Steelcut Trio	6-8 weeks	57.00 kg	20.888	26.110
		• Acca, Cifrado, Ecriture, Moss, Uniform Melange, Vidar	6-8 weeks	57.00 kg	23.276	29.095
		• Karakorum, Sisu	6-8 weeks	57.00 kg	31.040	38.800
		• Fuse, Gentle	6-8 weeks	57.00 kg	34.024	42.530
	Fabric usage: 4.9m*	• COM	6-8 weeks	57.00 kg	18.500	23.125
EV2G	Right open-ended 	• Hot Madison, Remix, Re-wool	6-8 weeks	57.00 kg	18.500	23.125
		• Canvas, Barnum, Fiord, Ritz	6-8 weeks	57.00 kg	20.292	25.365
		• Clay, Hallingdal, Steelcut Quartet, Steelcut Trio	6-8 weeks	57.00 kg	20.888	26.110
		• Acca, Cifrado, Ecriture, Moss, Uniform Melange, Vidar	6-8 weeks	57.00 kg	23.276	29.095
		• Karakorum, Sisu	6-8 weeks	57.00 kg	31.040	38.800
		• Fuse, Gentle	6-8 weeks	57.00 kg	34.024	42.530
	Fabric usage: 4.9m*	• COM	6-8 weeks	57.00 kg	18.500	23.125
30310010		Power outlet incl bracket (Schuko plug) *must be specified with the order	6-8 weeks		2.980	3.725

* Fabric usage is based on a 140cm roll



Material: Wooden frame, no-zag springs, HR foam and polyester wadding. Metal brackets for connecting modules.

Develius

Edward van Vliet

2018

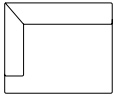
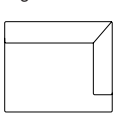

Model	Product	Upholstery	Lead time	Weight	PRICE EX. VAT (SEK)	PRICE INC. VAT (SEK)
EV1J	Left armrest  Fabric usage: 5.1m* Leather consumption: 9.1 sqm*	• Hot Madison, Remix, Re-wool	6-8 weeks		14.324	17.905
		• Canvas, Barnum, Fiord, Ritz	6-8 weeks		15.516	19.395
		• Clay, Hallingdal, Steelcut Quartet, Steelcut Trio	6-8 weeks		16.112	20.140
		• Acca, Cifrado, Ecriture, Moss, Uniform Melange, Vidar	6-8 weeks		19.100	23.875
		• Karakorum, Sisu	6-8 weeks		28.652	35.815
		• Fuse, Gentle	6-8 weeks		31.636	39.545
		• Noble Aniline leather	6-8 weeks		27.456	34.320
• COM	6-8 weeks		14.324	17.905		
EV1K	Right armrest  Fabric usage: 5.1m* Leather consumption: 9.1 sqm*	• Hot Madison, Remix, Re-wool	6-8 weeks		14.324	17.905
		• Canvas, Barnum, Fiord, Ritz	6-8 weeks		15.516	19.395
		• Clay, Hallingdal, Steelcut Quartet, Steelcut Trio	6-8 weeks		16.112	20.140
		• Acca, Cifrado, Ecriture, Moss, Uniform Melange, Vidar	6-8 weeks		19.100	23.875
		• Karakorum, Sisu	6-8 weeks		28.652	35.815
		• Fuse, Gentle	6-8 weeks		31.636	39.545
		• Noble Aniline leather	6-8 weeks		27.456	34.320
• COM	6-8 weeks		14.324	17.905		
EV2J	Left armrest  Fabric usage: 6m*	• Hot Madison, Remix, Re-wool	6-8 weeks		19.100	23.875
		• Canvas, Barnum, Fiord, Ritz	6-8 weeks		21.488	26.860
		• Clay, Hallingdal, Steelcut Quartet, Steelcut Trio	6-8 weeks		22.084	27.605
		• Acca, Cifrado, Ecriture, Moss, Uniform Melange, Vidar	6-8 weeks		24.472	30.590
		• Karakorum, Sisu	6-8 weeks		33.428	41.785
		• Fuse, Gentle	6-8 weeks		37.008	46.260
		• COM	6-8 weeks		19.100	23.875
EV2K	Right armrest  Fabric usage: 6m*	• Hot Madison, Remix, Re-wool	6-8 weeks		19.100	23.875
		• Canvas, Barnum, Fiord, Ritz	6-8 weeks		21.488	26.860
		• Clay, Hallingdal, Steelcut Quartet, Steelcut Trio	6-8 weeks		22.084	27.605
		• Acca, Cifrado, Ecriture, Moss, Uniform Melange, Vidar	6-8 weeks		24.472	30.590
		• Karakorum, Sisu	6-8 weeks		33.428	41.785
		• Fuse, Gentle	6-8 weeks		37.008	46.260
		• COM	6-8 weeks		19.100	23.875

* Fabric usage is based on a 140cm roll & Leather usage is based on a yield of 60% pr hide.

EV1 modules:

Seating Depth: 64cm / 25.2in, Seating Height: 42cm / 16.5in,
 Armrest Height: 70cm / 23.6in, Backrest Height: 70cm / 27.6in

Left armrest



W: 110cm / 43.3in

Right armrest



W: 110cm / 43.3in

EV2 modules:

Seating Depth: 85cm / 33.5in, Seating Height: 42cm / 16.5in,
 Armrest Height: 70cm / 23.6in, Backrest Height: 70cm / 27.6in

Left armrest



W: 131cm / 51.6in

Right armrest





W: 131cm / 51.6in

Develius ^{EV5-EV7}

Edward van Vliet

2018



Model	Product	Upholstery	Lead time	Weight	PRICE EX. VAT (SEK)	PRICE INC. VAT (SEK)
EV5	Pillow, large 	• Hot Madison, Remix, Re-wool	6-8 weeks	5.50 kg	1.904	2.380
		• Canvas, Barnum, Fiord, Ritz	6-8 weeks	5.50 kg	2.144	2.680
		• Clay, Hallingdal, Steelcut Quartet, Steelcut Trio,	6-8 weeks	5.50 kg	2.384	2.980
		• Acca, Cifrado, Ecriture, Moss, Uniform Melange, Vidar	6-8 weeks	5.50 kg	2.860	3.575
		• Karakorum, Sisu	6-8 weeks	5.50 kg	4.412	5.515
		• Fuse, Gentle	6-8 weeks	5.50 kg	4.888	6.110
	Fabric usage: 1.3m*	• COM	6-8 weeks	5.50 kg	1.904	2.380
EV6	Pillow, medium 	• Hot Madison, Remix, Re-wool	6-8 weeks	2.70 kg	1.548	1.935
		• Canvas, Barnum, Fiord, Ritz	6-8 weeks	2.70 kg	1.784	2.230
		• Clay, Hallingdal, Steelcut Quartet, Steelcut Trio,	6-8 weeks	2.70 kg	1.904	2.380
		• Acca, Cifrado, Ecriture, Moss, Uniform Melange, Vidar	6-8 weeks	2.70 kg	2.144	2.680
		• Karakorum, Sisu	6-8 weeks	2.70 kg	3.216	4.020
		• Fuse, Gentle	6-8 weeks	2.70 kg	3.576	4.470
	Fabric usage: 0.8m*	• COM	6-8 weeks	2.70 kg	1.548	1.935
EV7	Pillow, small 	• Hot Madison, Remix, Re-wool	6-8 weeks	1.30 kg	1.188	1.485
		• Canvas, Barnum, Fiord, Ritz	6-8 weeks	1.30 kg	1.308	1.635
		• Clay, Hallingdal, Steelcut Quartet, Steelcut Trio,	6-8 weeks	1.30 kg	1.428	1.785
		• Acca, Cifrado, Ecriture, Moss, Uniform Melange, Vidar	6-8 weeks	1.30 kg	1.548	1.935
		• Karakorum, Sisu	6-8 weeks	1.30 kg	2.264	2.830
		• Fuse, Gentle	6-8 weeks	1.30 kg	2.500	3.125
	Fabric usage: 0.5m*	• COM	6-8 weeks	1.30 kg	1.188	1.485

* Fabric usage is based on a 140cm roll

Material: Feather filling

COM must be approved by &Tradition to ensure suitability for upholstery.

Develius EV2-EV7 is not available in leather.



w: 80cm / 31.5in w: 50cm / 19.7in w: 50cm / 19.7in

NEW

Develius Mellow EV8A-EV8K

Edward van Vliet

2018

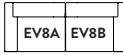
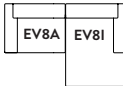
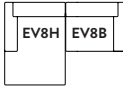
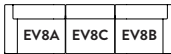
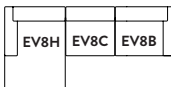
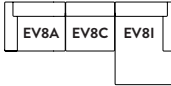
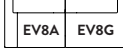

Model	Product	Upholstery	Lead time	PRICE EX.	PRICE INC.
				VAT (SEK)	VAT (SEK)
A	Configuration A 	• Hot Madison, Remix, Re-wool	6-8 weeks	33.424	41.780
		• Canvas, Barnum, Fiord, Ritz	6-8 weeks	35.808	44.760
		• Clay, Hallingdal, Steelcut Quartet, Steelcut Trio	6-8 weeks	37.000	46.250
		• Acca, Cifrado, Ecriture, Moss, Uniform Melange, Vidar	6-8 weeks	42.976	53.720
		• Karakorum, Sisu	6-8 weeks	62.080	77.600
		• Fuse, Gentle	6-8 weeks	68.048	85.060
		• COM	6-8 weeks	33.424	41.780
B	Configuration B 	• Hot Madison, Remix, Re-wool	6-8 weeks	37.600	47.000
		• Canvas, Barnum, Fiord, Ritz	6-8 weeks	39.988	49.985
		• Clay, Hallingdal, Steelcut Quartet, Steelcut Trio	6-8 weeks	41.180	51.475
		• Acca, Cifrado, Ecriture, Moss, Uniform Melange, Vidar	6-8 weeks	47.152	58.940
		• Karakorum, Sisu	6-8 weeks	67.452	84.315
		• Fuse, Gentle	6-8 weeks	74.020	92.525
		• COM	6-8 weeks	37.600	47.000
C	Configuration C 	• Hot Madison, Remix, Re-wool	6-8 weeks	37.600	47.000
		• Canvas, Barnum, Fiord, Ritz	6-8 weeks	39.988	49.985
		• Clay, Hallingdal, Steelcut Quartet, Steelcut Trio	6-8 weeks	41.180	51.475
		• Acca, Cifrado, Ecriture, Moss, Uniform Melange, Vidar	6-8 weeks	47.152	58.940
		• Karakorum, Sisu	6-8 weeks	67.452	84.315
		• Fuse, Gentle	6-8 weeks	74.020	92.525
		• COM	6-8 weeks	37.600	47.000
D	Configuration D 	• Hot Madison, Remix, Re-wool	6-8 weeks	47.748	59.685
		• Canvas, Barnum, Fiord, Ritz	6-8 weeks	51.324	64.155
		• Clay, Hallingdal, Steelcut Quartet, Steelcut Trio	6-8 weeks	53.112	66.390
		• Acca, Cifrado, Ecriture, Moss, Uniform Melange, Vidar	6-8 weeks	60.880	76.100
		• Karakorum, Sisu	6-8 weeks	87.148	108.935
		• Fuse, Gentle	6-8 weeks	95.504	119.380
		• COM	6-8 weeks	47.748	59.685
E	Configuration E 	• Hot Madison, Remix, Re-wool	6-8 weeks	51.924	64.905
		• Canvas, Barnum, Fiord, Ritz	6-8 weeks	55.504	69.380
		• Clay, Hallingdal, Steelcut Quartet, Steelcut Trio	6-8 weeks	57.292	71.615
		• Acca, Cifrado, Ecriture, Moss, Uniform Melange, Vidar	6-8 weeks	65.056	81.320
		• Karakorum, Sisu	6-8 weeks	92.520	115.650
		• Fuse, Gentle	6-8 weeks	101.476	126.845
		• COM	6-8 weeks	51.924	64.905
F	Configuration F 	• Hot Madison, Remix, Re-wool	6-8 weeks	51.924	64.905
		• Canvas, Barnum, Fiord, Ritz	6-8 weeks	55.504	69.380
		• Clay, Hallingdal, Steelcut Quartet, Steelcut Trio	6-8 weeks	57.292	71.615
		• Acca, Cifrado, Ecriture, Moss, Uniform Melange, Vidar	6-8 weeks	65.056	81.320
		• Karakorum, Sisu	6-8 weeks	92.520	115.650
		• Fuse, Gentle	6-8 weeks	101.476	126.845
		• COM	6-8 weeks	51.924	64.905
G	Configuration G 	• Hot Madison, Remix, Re-wool	6-8 weeks	32.824	41.030
		• Canvas, Barnum, Fiord, Ritz	6-8 weeks	35.808	44.760
		• Clay, Hallingdal, Steelcut Quartet, Steelcut Trio	6-8 weeks	37.000	46.250
		• Acca, Cifrado, Ecriture, Moss, Uniform Melange, Vidar	6-8 weeks	41.780	52.225
		• Karakorum, Sisu	6-8 weeks	59.092	73.865
		• Fuse, Gentle	6-8 weeks	65.064	81.330
		• COM	6-8 weeks	32.824	41.030

NEW

Develius Mellow ^{EV8A-EV8K}

Edward van Vliet

2018

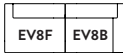
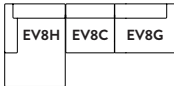
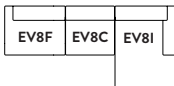

Model	Product	Upholstery	Lead time	PRICE EX.	PRICE INC.
				VAT (SEK)	VAT (SEK)
H	Configuration H 	• Hot Madison, Remix, Re-wool	6-8 weeks	32.824	41.030
		• Canvas, Barnum, Fiord, Ritz	6-8 weeks	35.808	44.760
		• Clay, Hallingdal, Steelcut Quartet, Steelcut Trio	6-8 weeks	37.000	46.250
		• Acca, Cifrado, Ecriture, Moss, Uniform Melange, Vidar	6-8 weeks	41.780	52.225
		• Karakorum, Sisu	6-8 weeks	59.092	73.865
		• Fuse, Gentle	6-8 weeks	65.064	81.330
		• COM	6-8 weeks	32.824	41.030
I	Configuration I 	• Hot Madison, Remix, Re-wool	6-8 weeks	51.324	64.155
		• Canvas, Barnum, Fiord, Ritz	6-8 weeks	55.504	69.380
		• Clay, Hallingdal, Steelcut Quartet, Steelcut Trio	6-8 weeks	57.292	71.615
		• Acca, Cifrado, Ecriture, Moss, Uniform Melange, Vidar	6-8 weeks	63.860	79.825
		• Karakorum, Sisu	6-8 weeks	89.532	111.915
		• Fuse, Gentle	6-8 weeks	98.492	123.115
		• COM	6-8 weeks	51.324	64.155
J	Configuration J 	• Hot Madison, Remix, Re-wool	6-8 weeks	51.324	64.155
		• Canvas, Barnum, Fiord, Ritz	6-8 weeks	55.504	69.380
		• Clay, Hallingdal, Steelcut Quartet, Steelcut Trio	6-8 weeks	57.292	71.615
		• Acca, Cifrado, Ecriture, Moss, Uniform Melange, Vidar	6-8 weeks	63.860	79.825
		• Karakorum, Sisu	6-8 weeks	89.532	111.915
		• Fuse, Gentle	6-8 weeks	98.492	123.115
		• COM	6-8 weeks	51.324	64.155

Material: Wooden frame, no-zag springs, HR foam and polyester wadding. Metal brackets for connecting modules.

Changeable cover

Felt gliders installed as standard.







NEW

Develius Mellow EV8A-EV8K

Edward van Vliet

2018



Model	Product	Upholstery	Lead time	PRICE EX.	PRICE INC.
				VAT (SEK)	VAT (SEK)
EV8A	 Left armrest Fabric usage: Xm*	• Hot Madison, Remix, Re-wool	6-8 weeks	16.712	20.890
		• Canvas, Barnum, Fiord, Ritz	6-8 weeks	17.904	22.380
		• Clay, Hallingdal, Steelcut Quartet, Steelcut Trio	6-8 weeks	18.500	23.125
		• Acca, Cifrado, Ecriture, Moss, Uniform Melange, Vidar	6-8 weeks	21.488	26.860
		• Karakorum, Sisu	6-8 weeks	31.040	38.800
		• Fuse, Gentle	6-8 weeks	34.024	42.530
		• COM	6-8 weeks	16.712	20.890
EV8B	 Right armrest Fabric usage: Xm*	• Hot Madison, Remix, Re-wool	6-8 weeks	16.712	20.890
		• Canvas, Barnum, Fiord, Ritz	6-8 weeks	17.904	22.380
		• Clay, Hallingdal, Steelcut Quartet, Steelcut Trio	6-8 weeks	18.500	23.125
		• Acca, Cifrado, Ecriture, Moss, Uniform Melange, Vidar	6-8 weeks	21.488	26.860
		• Karakorum, Sisu	6-8 weeks	31.040	38.800
		• Fuse, Gentle	6-8 weeks	34.024	42.530
		• COM	6-8 weeks	16.712	20.890
EV8C	 Center Fabric usage: Xm*	• Hot Madison, Remix, Re-wool	6-8 weeks	14.324	17.905
		• Canvas, Barnum, Fiord, Ritz	6-8 weeks	15.516	19.395
		• Clay, Hallingdal, Steelcut Quartet, Steelcut Trio	6-8 weeks	16.112	20.140
		• Acca, Cifrado, Ecriture, Moss, Uniform Melange, Vidar	6-8 weeks	17.904	22.380
		• Karakorum, Sisu	6-8 weeks	25.068	31.335
		• Fuse, Gentle	6-8 weeks	27.456	34.320
		• COM	6-8 weeks	14.324	17.905
EV8D	 Corner Fabric usage: Xm*	• Hot Madison, Remix, Re-wool	6-8 weeks	16.712	20.890
		• Canvas, Barnum, Fiord, Ritz	6-8 weeks	17.904	22.380
		• Clay, Hallingdal, Steelcut Quartet, Steelcut Trio	6-8 weeks	18.500	23.125
		• Acca, Cifrado, Ecriture, Moss, Uniform Melange, Vidar	6-8 weeks	21.488	26.860
		• Karakorum, Sisu	6-8 weeks	31.040	38.800
		• Fuse, Gentle	6-8 weeks	34.024	42.530
		• COM	6-8 weeks	16.712	20.890
EV8E	 Pouf Fabric usage: Xm*	• Hot Madison, Remix, Re-wool	6-8 weeks	12.532	15.665
		• Canvas, Barnum, Fiord, Ritz	6-8 weeks	13.724	17.155
		• Clay, Hallingdal, Steelcut Quartet, Steelcut Trio	6-8 weeks	14.324	17.905
		• Acca, Cifrado, Ecriture, Moss, Uniform Melange, Vidar	6-8 weeks	14.920	18.650
		• Karakorum, Sisu	6-8 weeks	18.500	23.125
		• Fuse, Gentle	6-8 weeks	20.292	25.365
		• COM	6-8 weeks	12.532	15.665
EV8F	 Left open-ended Fabric usage: Xm*	• Hot Madison, Remix, Re-wool	6-8 weeks	16.112	20.140
		• Canvas, Barnum, Fiord, Ritz	6-8 weeks	17.904	22.380
		• Clay, Hallingdal, Steelcut Quartet, Steelcut Trio	6-8 weeks	18.500	23.125
		• Acca, Cifrado, Ecriture, Moss, Uniform Melange, Vidar	6-8 weeks	20.292	25.365
		• Karakorum, Sisu	6-8 weeks	28.052	35.065
		• Fuse, Gentle	6-8 weeks	31.040	38.800
		• COM	6-8 weeks	16.112	20.140
EV8G	 Right open-ended Fabric usage: Xm*	• Hot Madison, Remix, Re-wool	6-8 weeks	16.112	20.140
		• Canvas, Barnum, Fiord, Ritz	6-8 weeks	17.904	22.380
		• Clay, Hallingdal, Steelcut Quartet, Steelcut Trio	6-8 weeks	18.500	23.125
		• Acca, Cifrado, Ecriture, Moss, Uniform Melange, Vidar	6-8 weeks	20.292	25.365
		• Karakorum, Sisu	6-8 weeks	28.052	35.065
		• Fuse, Gentle	6-8 weeks	31.040	38.800
		• COM	6-8 weeks	16.112	20.140

* Fabric usage is based on a 140cm roll





NEW

Develius Mellow EV8A-EV8K

Edward van Vliet

2018



Model	Product	Upholstery	Lead time	Weight	PRICE EX. VAT (SEK)	PRICE INC. VAT (SEK)
EV8H	 Left Chaiselong Fabric usage: Xm*	• Hot Madison, Remix, Re-wool	6-8 weeks		20.888	26.110
		• Canvas, Barnum, Fiord, Ritz	6-8 weeks		22.084	27.605
		• Clay, Hallingdal, Steelcut Quartet, Steelcut Trio	6-8 weeks		22.680	28.350
		• Acca, Cifrado, Ecriture, Moss, Uniform Melange, Vidar	6-8 weeks		25.664	32.080
		• Karakorum, Sisu	6-8 weeks		36.412	45.515
		• Fuse, Gentle	6-8 weeks		39.996	49.995
		• COM	6-8 weeks		20.888	26.110
EV8I	 Right Chaiselong Fabric usage: Xm*	• Hot Madison, Remix, Re-wool	6-8 weeks		20.888	26.110
		• Canvas, Barnum, Fiord, Ritz	6-8 weeks		22.084	27.605
		• Clay, Hallingdal, Steelcut Quartet, Steelcut Trio	6-8 weeks		22.680	28.350
		• Acca, Cifrado, Ecriture, Moss, Uniform Melange, Vidar	6-8 weeks		25.664	32.080
		• Karakorum, Sisu	6-8 weeks		36.412	45.515
		• Fuse, Gentle	6-8 weeks		39.996	49.995
		• COM	6-8 weeks		20.888	26.110
EV8J	 Left armrest Fabric usage: Xm*	• Hot Madison, Remix, Re-wool	6-8 weeks		16.712	20.890
		• Canvas, Barnum, Fiord, Ritz	6-8 weeks		17.904	22.380
		• Clay, Hallingdal, Steelcut Quartet, Steelcut Trio	6-8 weeks		18.500	23.125
		• Acca, Cifrado, Ecriture, Moss, Uniform Melange, Vidar	6-8 weeks		21.488	26.860
		• Karakorum, Sisu	6-8 weeks		31.040	38.800
		• Fuse, Gentle	6-8 weeks		34.024	42.530
		• COM	6-8 weeks		16.712	20.890
EV8K	 Right armrest Fabric usage: Xm*	• Hot Madison, Remix, Re-wool	6-8 weeks		16.712	20.890
		• Canvas, Barnum, Fiord, Ritz	6-8 weeks		17.904	22.380
		• Clay, Hallingdal, Steelcut Quartet, Steelcut Trio	6-8 weeks		18.500	23.125
		• Acca, Cifrado, Ecriture, Moss, Uniform Melange, Vidar	6-8 weeks		21.488	26.860
		• Karakorum, Sisu	6-8 weeks		31.040	38.800
		• Fuse, Gentle	6-8 weeks		34.024	42.530
		• COM	6-8 weeks		16.712	20.890

* Fabric usage is based on a 140cm roll

Material: Wooden frame, no-zag springs, HR foam and polyester wadding. Metal brackets for connecting modules.

Changeable cover

COM must be approved by &Tradition to ensure suitability for upholstery.

Felt gliders installed as standard.







Isole NN1A-NN1G

Nendo & Luca Nichetto



2017



Dimensions

Seat	Back	Armrest	Round Table	Rectangular Table	Square Table
 <p>D: 65cm / 25.6in</p>	 <p>D: 20cm / 7.9in</p>	 <p>D: 67cm / 26.4in</p>	 <p>Ø: 30cm / 11.8in</p>	 <p>D: 65cm / 25.6in</p>	 <p>D: 65cm / 25.6in</p>
W: 65cm / 25.6in	W: 67cm / 26.4in	W: 20cm / 7.9in		w: 20cm / 7.9in	w: 65cm / 25.6in

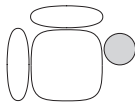
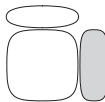
Simple configurations

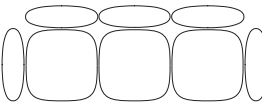
 <p>D: 65cm / 25.59in</p>	 <p>w: 118.6cm / 46.69in</p>	 <p>w: 87.5cm / 34.4in</p>	 <p>w: 176cm / 69.3in</p>	 <p>w: 242.2cm / 95.35in</p>	<p>D: 87.6 cm / 34.48 in</p>
---	--	--	--	--	------------------------------

Configurations

Please visit: <https://isole.andtradition.com> to configure your own Isole.

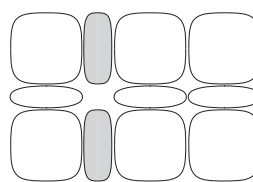
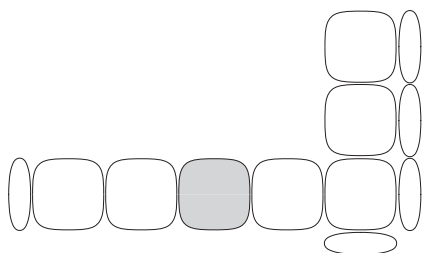
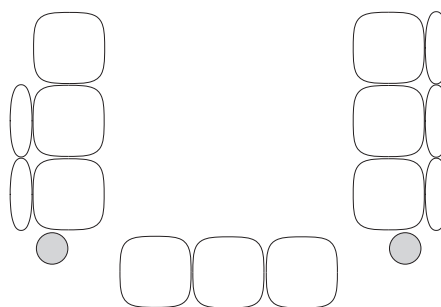
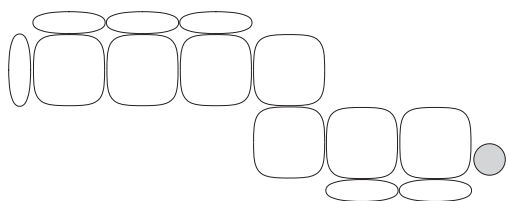

Isole NN1A-NN1G

Nendo & Luca Nichetto

2017



Item code	Upholstery	Model	Product	Lead time	PRICE EX. VAT (SEK)	PRICE INC. VAT (SEK)
Fabric gr. 1	Hot Madison, Remix	NN1A	Seat	6-8 weeks	6.560	8.200
		NN1B	Back	6-8 weeks	5.368	6.710
		NN1C	Arm	6-8 weeks	4.772	5.965
Fabric gr. 2	Canvas, Barnum	NN1A	Seat	6-8 weeks	7.756	9.695
		NN1B	Back	6-8 weeks	6.560	8.200
		NN1C	Arm	6-8 weeks	5.368	6.710
Fabric gr. 3	Hallingdal, Steelcut Quartet, Steelcut Trio	NN1A	Seat	6-8 weeks		
		NN1B	Back	6-8 weeks		
		NN1C	Arm	6-8 weeks		
Fabric gr. 4	Acca, Cifrado, Ecriture, Moss, Uniform Melange, Vidar	NN1A	Seat	6-8 weeks	8.948	11.185
		NN1B	Back	6-8 weeks	7.756	9.695
		NN1C	Arm	6-8 weeks	6.560	8.200
Fabric gr. 5	Karakorum, Sisu	NN1A	Seat	6-8 weeks	11.336	14.170
		NN1B	Back	6-8 weeks	8.948	11.185
		NN1C	Arm	6-8 weeks	7.756	9.695
Fabric gr. 6	Fuse, Gentle	NN1A	Seat	6-8 weeks	12.532	15.665
		NN1B	Back	6-8 weeks	9.784	12.230
		NN1C	Arm	6-8 weeks	8.592	10.740

Item code	Table top finishes	Model	Product	Lead time	PRICE EX. VAT (SEK)	PRICE INC. VAT (SEK)
NN	Fenix laminate Black	NN1D	Round Table	6-8 weeks	4.172	5.215
		NN1E	Rectangular Table	6-8 weeks	4.412	5.515
		NN1F	Square Table	6-8 weeks	6.560	8.200
30310001	Power outlet incl bracket (DK plug) *must be specified with the order				2.980	3.725

Item code	Base	Model	Lead time	PRICE EX. VAT (SEK)	PRICE INC. VAT (SEK)
NN	Optional floor fixing set (2 pcs in one set)	NN1G	3-6 weeks	1.188	1.485

Base Colour

Steel Black

Material: Powder coated steel base, moulded HR foam seat, backrest and armrest. Black MDF table tops with nano laminate surface.

Modular system including base. Use model-app for configuration:
<https://isole.andtradition.com>.

Plastic gliders installed as standard.

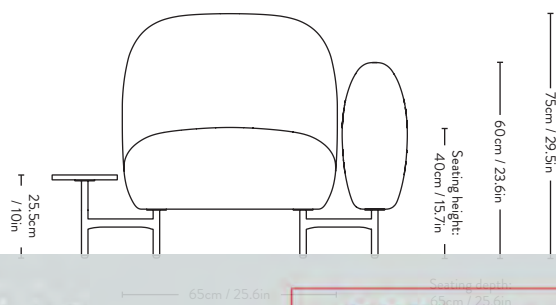

Fly SC10

Space Copenhagen

2017



Item no.	Product	Base	Model	Colli qty.	Lead time	Weight	PRICE EX. VAT (SEK)	PRICE INC. VAT (SEK)
65173001	Hot Madison 094	Oiled Oak	SC10	1 pc	Stock item	22.00 kg	19.100	23.875
65173002	Hot Madison 093	Smoked Oiled Oak	SC10	1 pc	Stock item	22.00 kg	19.100	23.875

Item no.	Upholstery	Model	Lead time	Weight	PRICE EX. VAT (SEK)	PRICE INC. VAT (SEK)
Fabric gr. 1	Hot Madison, Remix, Re-Wool	SC10	6-8 weeks	22.00 kg	20.292	25.365
Fabric gr. 2	Canvas, Barnum, Fiord, Ritz	SC10	6-8 weeks	22.00 kg	20.888	26.110
Fabric gr. 3	Clay, Hallingdal, Steelcut Quartet, Steelcut Trio	SC10	6-8 weeks	22.00 kg	21.488	26.860
Fabric gr. 4	Acca, Cifrado, Ecriture, Moss, Uniform Melange, Vidar	SC10	6-8 weeks	22.00 kg	23.276	29.095
Fabric gr. 5	Karakorum, Sisu	SC10	6-8 weeks	22.00 kg	26.264	32.830
Fabric gr. 6	Fuse, Gentle	SC10	6-8 weeks	22.00 kg	29.248	36.560
Fabric COM	COM Fabric	SC10	6-8 weeks	22.00 kg	20.292	25.365

Item no.	Add on	Lead time	Weight	PRICE EX. VAT (SEK)	PRICE INC. VAT (SEK)
65151000-3	Fly high legs - Oiled Oak (providing a seating height of 46cm / 18.1in)	Stock item	1.50 kg	948	1.185
65151100-3	Fly high legs - Smoked Oiled Oak (providing a seating height of 46cm / 18.1in)	Stock item	1.50 kg	948	1.185

Frame Finish

Oak Oiled Oak, Smoked Oiled Oak

Material: Oiled oak frame and base. HR foam & feather pillows.

Fabric usage: 3 meters based on 140cm roll.

COM must be approved by Tradition to ensure suitability for upholstery.

Fly SC10 is not available in leather.

Felt gliders installed as standard.

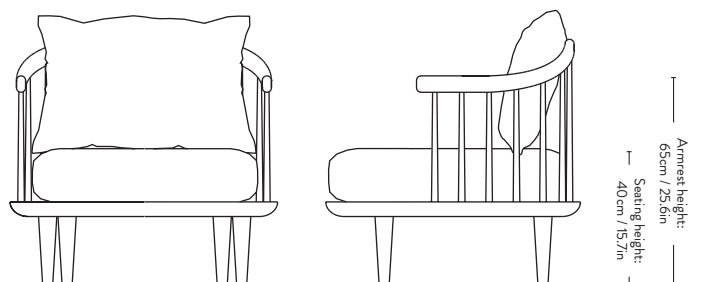

Fly SC1

Space Copenhagen

2013



Item no.	Product	Base	Model	Colli qty.	Lead time	Weight	PRICE EX. VAT (SEK)	PRICE INC. VAT (SEK)
65113001	Hot Madison 094	Oiled Oak	SC1	1 pc	Stock item	30.00 kg	20.292	25.365
65113002	Hot Madison 093	Smoked Oiled Oak	SC1	1 pc	Stock item	30.00 kg	20.292	25.365

Item no.	Upholstery	Model	Lead time	Weight	PRICE EX. VAT (SEK)	PRICE INC. VAT (SEK)
Fabric gr. 1	Hot Madison, Remix, Re-Wool	SC1	6-8 weeks	30.00 kg	21.488	26.860
Fabric gr. 2	Canvas, Barnum, Fiord, Ritz	SC1	6-8 weeks	30.00 kg	23.876	29.845
Fabric gr. 3	Clay, Hallingdal, Steelcut Quartet, Steelcut Trio	SC1	6-8 weeks	30.00 kg	24.472	30.590
Fabric gr. 4	Acca, Cifrado, Ecriture, Moss, Uniform Melange, Vidar	SC1	6-8 weeks	30.00 kg	26.264	32.830
Fabric gr. 5	Karakorum, Sisu	SC1	6-8 weeks	30.00 kg	29.844	37.305
Fabric gr. 6	Fuse, Gentle	SC1	6-8 weeks	30.00 kg	32.828	41.035
Fabric COM	COM Fabric	SC1	6-8 weeks	30.00 kg	21.488	26.860

Item no.	Add on	Lead time	Weight	PRICE EX. VAT (SEK)	PRICE INC. VAT (SEK)
65151000-3	Fly high legs - Oiled Oak (providing a seating height of 46cm / 18.1in)	Stock item	1.50 kg	948	1.185
65151100-3	Fly high legs - Smoked Oiled Oak (providing a seating height of 46cm / 18.1in)	Stock item	1.50 kg	948	1.185

Frame Finish

Oak Oiled Oak, Smoked Oiled Oak

Material: Oiled oak frame and base. HR foam & feather pillows.

Fabric usage: 3.5 meters based on 140cm roll.

COM must be approved by &Tradition to ensure suitability for upholstery.

Fly SC1 is not available in leather.

Felt gliders installed as standard.

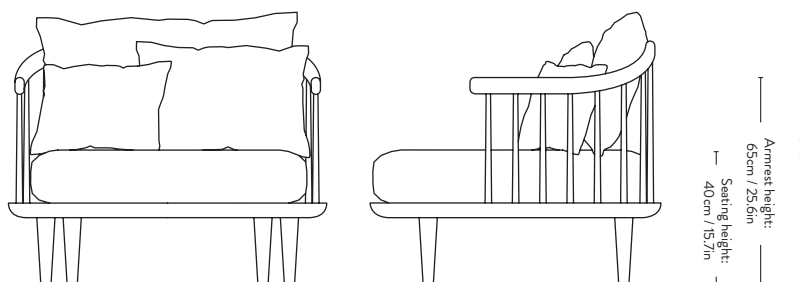

Fly^{SC2} Space Copenhagen 2013



Item no.	Product	Base	Model	Colli qty.	Lead time	Weight	PRICE EX. VAT (SEK)	PRICE INC. VAT (SEK)
65123001	Hot Madison 094	Oiled Oak	SC2	1 pc	Stock item	60.00 kg	35.816	44.770
65123002	Hot Madison 093	Smoked Oiled Oak	SC2	1 pc	Stock item	60.00 kg	35.816	44.770

Item no.	Upholstery	Model	Lead time	Weight	PRICE EX. VAT (SEK)	PRICE INC. VAT (SEK)
Fabric gr. 1	Hot Madison, Remix, Re-Wool	SC2	6-8 weeks	60.00 kg	38.204	47.755
Fabric gr. 2	Canvas, Barnum, Fiord, Ritz	SC2	6-8 weeks	60.00 kg	41.784	52.230
Fabric gr. 3	Clay, Hallingdal, Steelcut Quartet, Steelcut Trio	SC2	6-8 weeks	60.00 kg	42.980	53.725
Fabric gr. 4	Acca, Cifrado, Ecriture, Moss, Uniform Melange, Vidar	SC2	6-8 weeks	60.00 kg	45.368	56.710
Fabric gr. 5	Karakorum, Sisu	SC2	6-8 weeks	60.00 kg	53.724	67.155
Fabric gr. 6	Fuse, Gentle	SC2	6-8 weeks	60.00 kg	59.696	74.620
Fabric COM	COM Fabric	SC2	6-8 weeks	60.00 kg	38.204	47.755

Item no.	Add on	Lead time	Weight	PRICE EX. VAT (SEK)	PRICE INC. VAT (SEK)
65151000-3	Fly high legs - Oiled Oak (providing a seating height of 46cm / 18.1in)	Stock item	1.50 kg	948	1.185
65151100-3	Fly high legs - Smoked Oiled Oak (providing a seating height of 46cm / 18.1in)	Stock item	1.50 kg	948	1.185

Frame	Finish
Oak	Oiled Oak, Smoked Oiled Oak

Material: Oiled oak frame and base. HR foam & feather pillows.

Fabric usage: 6.5 meters based on 140cm roll.

COM must be approved by &Tradition to ensure suitability for upholstery.

Fly SC2 is not available in leather.

Felt gliders installed as standard.

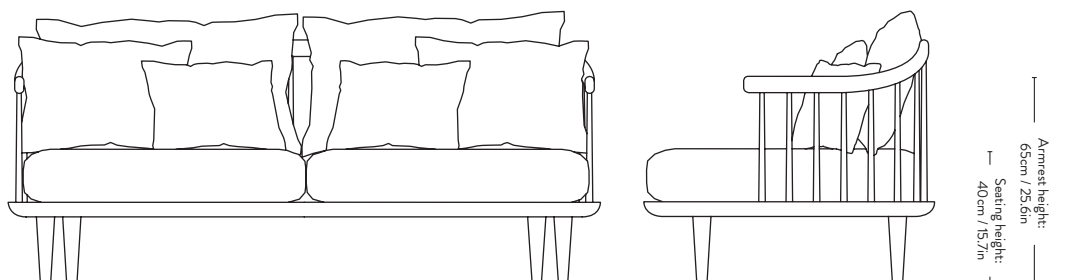

Fly SC3

Space Copenhagen

2013



Item no.	Product	Base	Model	Colli qty.	Lead time	Weight	PRICE EX. VAT (SEK)	PRICE INC. VAT (SEK)
65133001	Hot Madison 094	Oiled Oak	SC3	1 pc	2-4 weeks	70.00 kg	38.204	47.755
65133002	Hot Madison 093	Smoked Oiled Oak	SC3	1 pc	2-4 weeks	70.00 kg	38.204	47.755

Item no.	Upholstery	Model	Lead time	Weight	PRICE EX. VAT (SEK)	PRICE INC. VAT (SEK)
Fabric gr. 1	Hot Madison, Remix, Re-Wool	SC3	6-8 weeks	70.00 kg	41.784	52.230
Fabric gr. 2	Canvas, Barnum, Fiord, Ritz	SC3	6-8 weeks	70.00 kg	45.368	56.710
Fabric gr. 3	Clay, Hallingdal, Steelcut Quartet, Steelcut Trio	SC3	6-8 weeks	70.00 kg	46.560	58.200
Fabric gr. 4	Acca, Cifrado, Ecriture, Moss, Uniform Melange, Vidar	SC3	6-8 weeks	70.00 kg	48.948	61.185
Fabric gr. 5	Karakorum, Sisu	SC3	6-8 weeks	70.00 kg	57.308	71.635
Fabric gr. 6	Fuse, Gentle	SC3	6-8 weeks	70.00 kg	63.276	79.095
Fabric COM	COM Fabric	SC3	6-8 weeks	70.00 kg	41.784	52.230

Item no.	Add on	Lead time	Weight	PRICE EX. VAT (SEK)	PRICE INC. VAT (SEK)
65151000-3	Fly high legs - Oiled Oak (providing a seating height of 46cm / 18.1in)	Stock item	1.50 kg	948	1.185
65151100-3	Fly high legs - Smoked Oiled Oak (providing a seating height of 46cm / 18.1in)	Stock item	1.50 kg	948	1.185

Frame Finish

Oak Oiled Oak, Smoked Oiled Oak

Material: Oiled oak frame and base. HR foam & feather pillows.

Fabric usage: 6.5 meters based on 140cm roll.

COM must be approved by &Tradition to ensure suitability for upholstery.

Fly SC3 is not available in leather.

Felt gliders installed as standard.

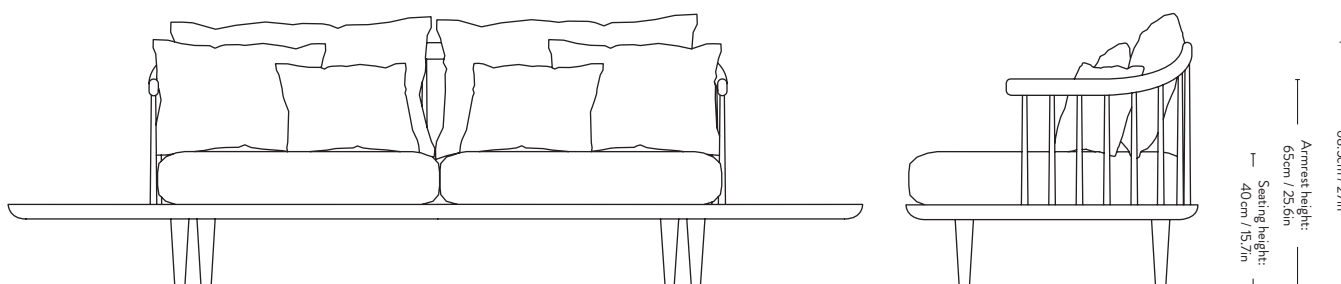

Fly SC12 Space Copenhagen 2017



Item no.	Product	Base	Model	Colli qty.	Lead time	Weight	PRICE EX. VAT (SEK)	PRICE INC. VAT (SEK)
65193001	Hot Madison 094	Oiled Oak	SC12	1 pc	6-8 weeks	80.00 kg	53.724	67.155
65193002	Hot Madison 093	Smoked Oiled Oak	SC12	1 pc	6-8 weeks	80.00 kg	53.724	67.155

Item no.	Upholstery	Model	Lead time	Weight	PRICE EX. VAT (SEK)	PRICE INC. VAT (SEK)
Fabric gr. 1	Hot Madison, Remix, Re-Wool	SC12	6-8 weeks	80.00 kg	53.724	67.155
Fabric gr. 2	Canvas, Barnum, Fiord, Ritz	SC12	6-8 weeks	80.00 kg	57.308	71.635
Fabric gr. 3	Clay, Hallingdal, Steelcut Quartet, Steelcut Trio	SC12	6-8 weeks	80.00 kg	58.500	73.125
Fabric gr. 4	Acca, Cifrado, Ecriture, Moss, Uniform Melange, Vidar	SC12	6-8 weeks	80.00 kg	62.084	77.605
Fabric gr. 5	Karakorum, Sisu	SC12	6-8 weeks	80.00 kg	77.604	97.005
Fabric gr. 6	Fuse, Gentle	SC12	6-8 weeks	80.00 kg	85.368	106.710
Fabric COM	COM Fabric	SC12	6-8 weeks	80.00 kg	53.724	67.155

Item no.	Add on	Lead time	Weight	PRICE EX. VAT (SEK)	PRICE INC. VAT (SEK)
65151000-3	Fly high legs - Oiled Oak (providing a seating height of 46cm / 18.1in)	Stock item	1.50 kg	948	1.185
65151100-3	Fly high legs - Smoked Oiled Oak (providing a seating height of 46cm / 18.1in)	Stock item	1.50 kg	948	1.185

Frame	Finish
Oak	Oiled Oak, Smoked Oiled Oak

Material: Oiled oak frame and base. HR foam and feather pillows. Fabric upholstery.

Fabric usage: 8 meters based on 140cm roll.

COM must be approved by &Tradition to ensure suitability for upholstery.

Fly SC12 is not available in leather.

Felt gliders installed as standard.

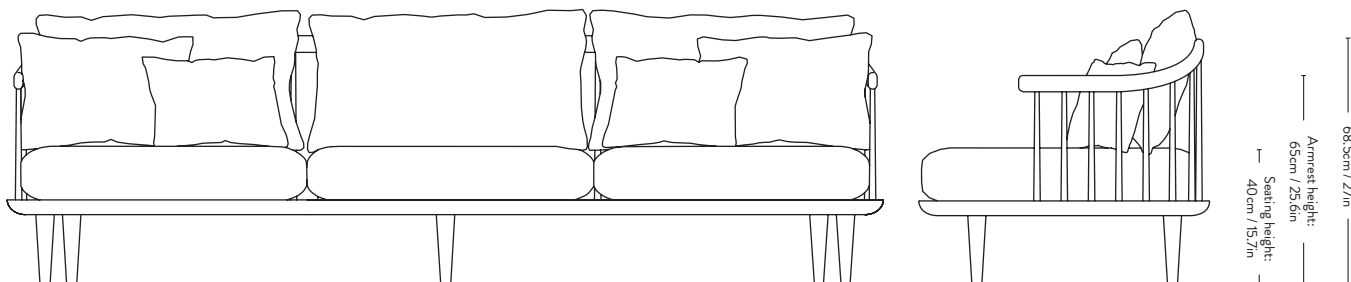

Fly^{SC9} Space Copenhagen 2014



Item no.	Product	Base	Model	Colli qty.	Lead time	Weight	PRICE EX. VAT (SEK)	PRICE INC. VAT (SEK)
65143001	Hot Madison 094	Oiled Oak	SC9	1 pc	2-4 weeks	27.00 kg	10.740	13.425
65143002	Hot Madison 093	Smoked Oiled Oak	SC9	1 pc	2-4 weeks	27.00 kg	10.740	13.425

Item no.	Upholstery	Model	Lead time	Weight	PRICE EX. VAT (SEK)	PRICE INC. VAT (SEK)
Fabric gr. 1	Hot Madison, Remix, Re-Wool	SC9	6-8 weeks	27.00 kg	11.936	14.920
Fabric gr. 2	Canvas, Barnum, Fiord, Ritz	SC9	6-8 weeks	27.00 kg	13.128	16.410
Fabric gr. 3	Clay, Hallingdal, Steelcut Quartet, Steelcut Trio	SC9	6-8 weeks	27.00 kg	13.724	17.155
Fabric gr. 4	Acca, Cifrado, Ecriture, Moss, Uniform Melange, Vidar	SC9	6-8 weeks	27.00 kg	14.324	17.905
Fabric gr. 5	Karakorum, Sisu	SC9	6-8 weeks	27.00 kg	16.712	20.890
Fabric gr. 6	Fuse, Gentle	SC9	6-8 weeks	27.00 kg	18.500	23.125
Fabric COM	COM Fabric	SC9	6-8 weeks	27.00 kg	11.936	14.920

Item no.	Add on	Lead time	Weight	PRICE EX. VAT (SEK)	PRICE INC. VAT (SEK)
65151000-3	Fly high legs - Oiled Oak (providing a seating height of 46cm / 18.1in)	Stock item	1.50 kg	948	1.185
65151100-3	Fly high legs - Smoked Oiled Oak (providing a seating height of 46cm / 18.1in)	Stock item	1.50 kg	948	1.185

Frame	Finish
Oak	Oiled Oak, Smoked Oiled Oak

Material: Oiled oak base. HR foam & feather pillow.

Fabric usage: 1.8 meters based on 140cm roll.

COM must be approved by Tradition to ensure suitability for upholstery.

Fly SC9 is not available in leather.

Felt gliders installed as standard.

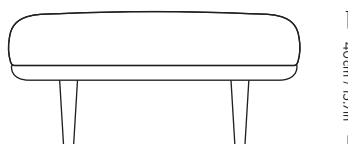

Fly SC4 & SC5 Space Copenhagen 2013



Item no.	Product	Model	Colli qty.	Lead time	Weight	PRICE EX. VAT (SEK)	PRICE INC. VAT (SEK)
65151000	Oiled Oak base w. honed Bianco Carrara marble	SC4	1 pc	Stock item	37.00 kg	15.516	19.395
65151400	Smoked Oiled Oak base w. honed Nero Marquina marble	SC4	1 pc	Stock item	37.00 kg	15.516	19.395
65161000	Oiled Oak base w. honed Bianco Carrara marble	SC5	1 pc	Stock item	45.00 kg	16.712	20.890
65161400	Smoked Oiled Oak base w. honed Nero Marquina marble	SC5	1 pc	Stock item	45.00 kg	16.712	20.890

Item no.	Add on	Lead time	Weight	PRICE EX. VAT (SEK)	PRICE INC. VAT (SEK)
65151000-3	Fly high legs - Oiled Oak (providing a tabletop height of 32cm / 12.6in)	Stock item	1.50 kg	948	1.185
65151100-3	Fly high legs - Smoked Oiled Oak (providing a tabletop height of 32cm / 12.6in)	Stock item	1.50 kg	948	1.185

Material: Solid oiled oak base with marble table top.

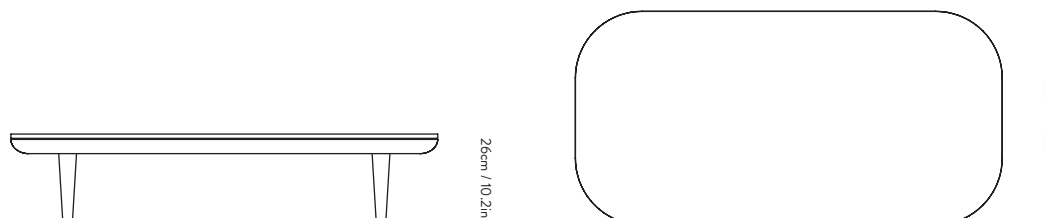
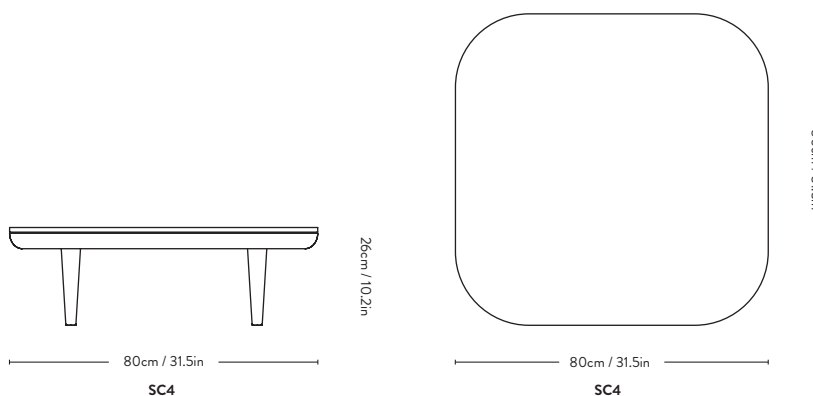

Fly^{SC11} Space Copenhagen 2017



Item no.	Product	Model	Colli qty.	Lead time	Weight	PRICE EX. VAT (SEK)	PRICE INC. VAT (SEK)
65181000	Oiled Oak base w. honed Bianco Carrara marble	SC11	1 pc	Stock item	102.00 kg	29.844	37.305
65181100	Smoked Oiled Oak base w. honed Nero Marquina marble	SC11	1 pc	Stock item	102.00 kg	29.844	37.305

Material: Solid oiled oak base with marble table top.

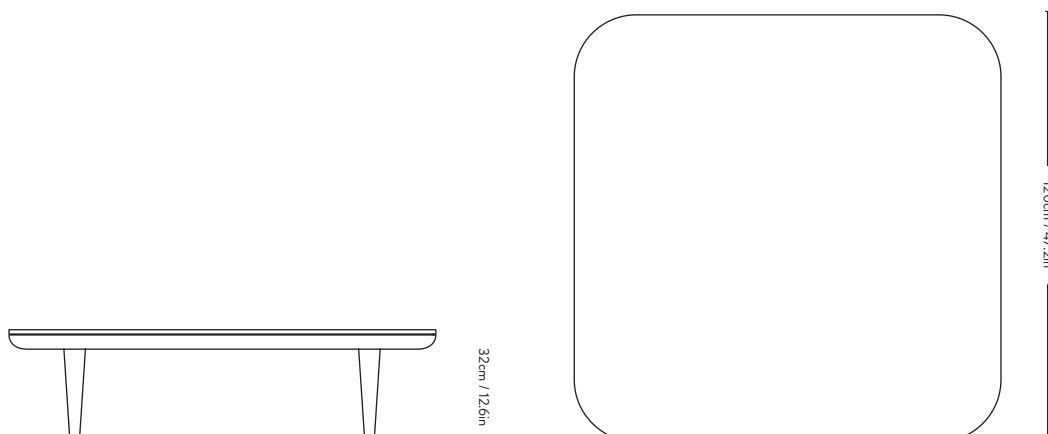

NEW

Sett LN11, LN12 & LN13

Luca Nichetto 2024



Item no.	Product	Model	Colour	Colli qty.	Lead time	Weight	PRICE EX. VAT (SEK)	PRICE INC. VAT (SEK)
19001000	Sett side table	LN11	Smoked cast glass w. Dark Chrome	1 pc	Stock item	12.30 kg	10.740	13.425
19001001	Sett side table	LN11	Bianco Carrera Marble w. Dark chrome	1 pc	Stock item	10.30 kg	8.352	10.440
19001002	Sett side table	LN11	Verde Guatemala Marble w. Dark chrome	1 pc	Stock item	10.30 kg	8.352	10.440
19001003	Sett coffee table	LN12	Smoked cast glass w. Dark Chrome	1 pc	Stock item	53.60 kg	22.680	28.350
19001004	Sett coffee table	LN12	Bianco Carrera Marble w. Dark chrome	1 pc	Stock item	44.60 kg	17.904	22.380
19001005	Sett coffee table	LN12	Verde Guatemala Marble w. Dark chrome	1 pc	Stock item	44.60 kg	17.904	22.380
19001006	Sett coffee table	LN13	Smoked cast glass w. Dark Chrome	1 pc	Stock item	63.60 kg	23.876	29.845
19001007	Sett coffee table	LN13	Bianco Carrera Marble w. Dark chrome	1 pc	Stock item	51.60 kg	19.100	23.875
19001008	Sett coffee table	LN13	Verde Guatemala Marble w. Dark chrome	1 pc	Stock item	51.60 kg	19.100	23.875

Material: Die cast, aluminium with cast glass or marble table top

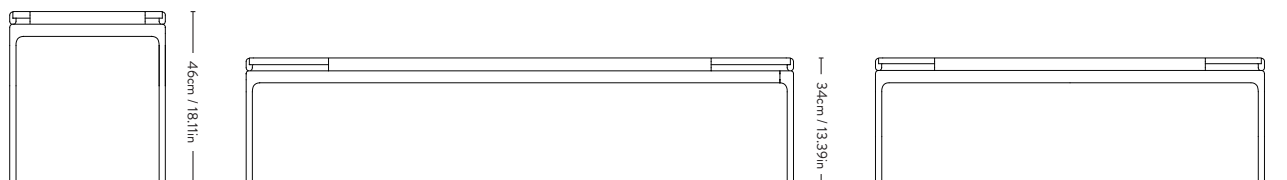

In Between ^{SK13-SK15} Sami Kallio 2014



Item no.	Product	Size	Model	Colli qty.	Lead time	Weight	PRICE EX. VAT (SEK)	PRICE INC. VAT (SEK)
20982200	Smoked Oiled Oak	Ø48cm, H:48cm	SK13	1 pc	Stock item	4.00 kg	2.980	3.725
20982292	Oiled Oak	Ø48cm, H:48cm	SK13	1 pc	Stock item	4.00 kg	2.980	3.725
20982294	Black Lacquered Oak	Ø48cm, H:48cm	SK13	1 pc	Stock item	4.00 kg	2.980	3.725
20982300	Smoked Oiled Oak	Ø60cm, H:40cm	SK14	1 pc	Stock item	5.90 kg	3.936	4.920
20982392	Oiled Oak	Ø60cm, H:40cm	SK14	1 pc	Stock item	5.90 kg	3.936	4.920
20982394	Black Lacquered Oak	Ø60cm, H:40cm	SK14	1 pc	Stock item	5.90 kg	3.936	4.920
20982400	Smoked Oiled Oak	Ø90cm, H:48cm	SK15	1 pc	Stock item	13.00 kg	5.368	6.710
20982492	Oiled Oak	Ø90cm, H:48cm	SK15	1 pc	Stock item	13.00 kg	5.368	6.710
20982494	Black Lacquered Oak	Ø90cm, H:48cm	SK15	1 pc	Stock item	13.00 kg	5.368	6.710

Materials **Finishes**

Table top	Solid Oak
Table legs	Solid Oak

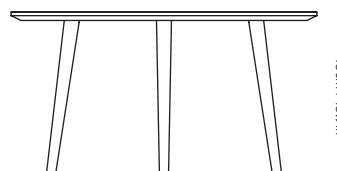
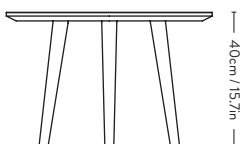
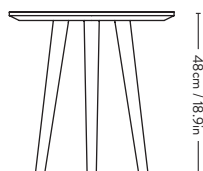

In Between ^{SK23 & SK24} Sami Kallio 2014



Item no.	Product	Size	Model	Colli qty.	Lead time	Weight	PRICE EX. VAT (SEK)	PRICE INC. VAT (SEK)
20982594	Black Lacquered Oak	W: 110cm, D: 50cm, H: 48cm	SK23	1 pc	Stock item	11.30 kg	5.368	6.710
20982592	Oiled Oak	W: 110cm, D: 50cm H: 48cm	SK23	1 pc	Stock item	11.30 kg	5.368	6.710
20982500	Smoked Oiled Oak	W: 110cm, D: 50cm H: 48cm	SK23	1 pc	Stock item	11.30 kg	5.368	6.710
20982694	Black Lacquered Oak	W: 90cm, D: 90cm, H: 40cm	SK24	1 pc	Stock item	16.80 kg	5.604	7.005
20982692	Oiled Oak	W: 90cm, D: 90cm, H: 40cm	SK24	1 pc	Stock item	16.80 kg	5.604	7.005
20982600	Smoked Oiled Oak	W: 90cm, D: 90cm, H: 40cm	SK24	1 pc	Stock item	16.80 kg	5.604	7.005

Materials **Finishes**

Table top	Solid Oak
Table legs	Solid Oak

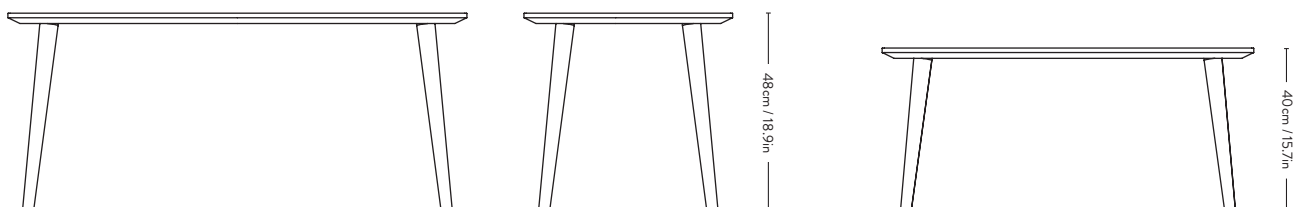

In Between ^{SK3 & SK4} Sami Kallio 2014

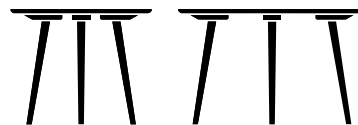

Item no.	Product	Size	Model	Colli qty.	Lead time	Weight	PRICE EX. VAT (SEK)	PRICE INC. VAT (SEK)
20981100	Smoked Oiled Oak	Ø90cm	SK3	1 pc	Stock item	19.00 kg	8.592	10.740
20981192	Oiled Oak	Ø90cm	SK3	1 pc	Stock item	19.00 kg	8.592	10.740
20981194	Black Lacquered Oak	Ø90cm	SK3	1 pc	Stock item	19.00 kg	8.592	10.740
20981196	Oiled Walnut	Ø90cm	SK3	1 pc	Stock item	19.00 kg	15.516	19.395
20981200	Smoked Oiled Oak	Ø120cm	SK4	1 pc	Stock item	31.00 kg	13.724	17.155
20981292	Oiled Oak	Ø120cm	SK4	1 pc	Stock item	31.00 kg	13.724	17.155
20981294	Black Lacquered Oak	Ø120cm	SK4	1 pc	Stock item	31.00 kg	13.724	17.155
20981296	Oiled Walnut	Ø120cm	SK4	1 pc	Stock item	31.00 kg	23.876	29.845

Materials Finishes

Table top	Solid Oak, Solid Walnut
Table legs	Solid Oak, Solid Walnut

Adjustable gliders installed as standard.

Bevelled table top edge.

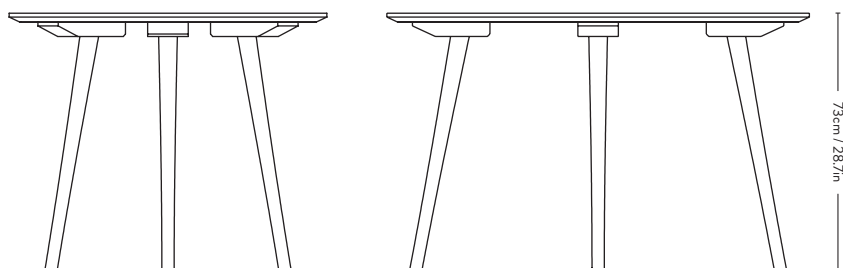

Ø: 90cm / 35 4/8"

SK3

Ø: 120cm / 47 2/8"

In Between ^{SK5 & SK6} Sami Kallio 2014



Item no.	Product	Size	Model	Colli qty.	Lead time	Weight	PRICE EX. VAT (SEK)	PRICE INC. VAT (SEK)
20981300	Smoked Lacquered Oak	90x200cm	SK5	1 pc	Stock item	52.40 kg	15.516	19.395
20981392	Clear Lacquered Oak	90x200cm	SK5	1 pc	Stock item	52.40 kg	15.516	19.395
20981394	Black Lacquered Oak	90x200cm	SK5	1 pc	Stock item	52.40 kg	15.516	19.395
20981400	Smoked Lacquered Oak	100x250cm	SK6	1 pc	Stock item	67.10 kg	17.904	22.380
20981492	Clear Lacquered Oak	100x250cm	SK6	1 pc	Stock item	67.10 kg	17.904	22.380
20981494	Black Lacquered Oak	100x250cm	SK6	1 pc	Stock item	67.10 kg	17.904	22.380

Materials Finishes

Table top	Oak Veneer on both sides and edges
Table legs	Solid Oak

Adjustable gliders installed as standard.

Bevelled table top edge.

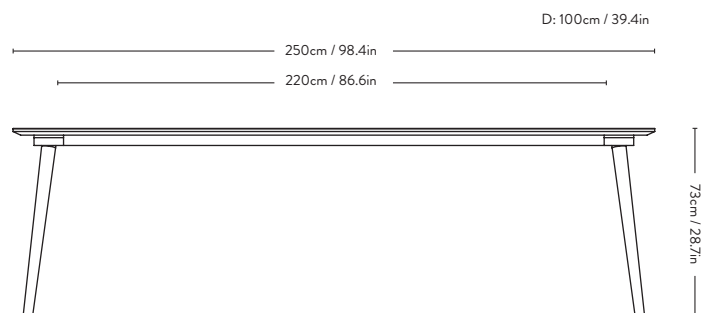
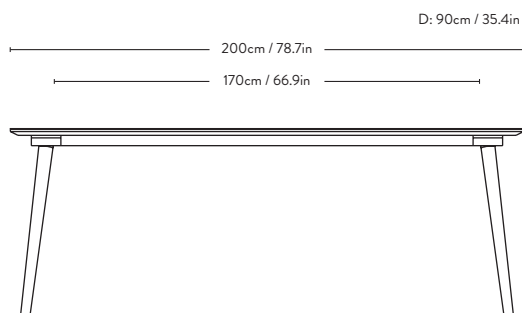

In Between ^{Made to order} Sami Kallio 2014

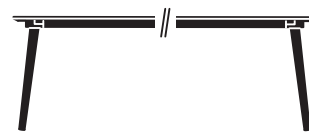

Item no.	Product	*Edge material	Size	Lead time	PRICE EX. VAT (SEK)	PRICE INC. VAT (SEK)
20981500	Oak veneer, Forbo Linoleum	Info below	L:90cm, W:90cm, H:73cm	8 weeks	19.100	23.875
20981600	Oak veneer, Forbo Linoleum	Info below	L:160-200cm, W:90cm, H:73cm	8 weeks	19.100	23.875
20981700	Oak veneer, Forbo Linoleum	Info below	L:201-250cm, W:100cm, H:73cm	8 weeks	23.876	29.845
20983000	Oak veneer, Forbo Linoleum	Info below	Ø:81-90cm, H:73cm (3 legs)	8 weeks	11.936	14.920
20983100	Oak veneer, Forbo Linoleum	Info below	Ø:91-100cm, H:73cm (3 legs)	8 weeks	13.128	16.410
20983200	Oak veneer, Forbo Linoleum	Info below	Ø:101-110cm, H:73cm (4 legs)	8 weeks	13.724	17.155
20983300	Oak veneer, Forbo Linoleum	Info below	Ø:111-120cm, H:73cm (4 legs)	8 weeks	14.920	18.650
20983400	Oak veneer, Forbo Linoleum	Info below	Ø:121-130cm, H:73cm (4 legs)	8 weeks	17.308	21.635
20983500	Oak veneer, Forbo Linoleum	Info below	Ø:131-140cm, H:73cm (4 legs)	8 weeks	19.696	24.620
20983600	Oak veneer, Forbo Linoleum	Info below	Ø:141-150cm, H:73cm (4 legs)	8 weeks	20.888	26.110
20981501	Fenix NTM nano laminate	Info below	L:90cm, W:90cm, H:73cm	8 weeks	11.936	14.920
20981601	Fenix NTM nano laminate	Info below	L:160-200cm, W:90cm, H:73cm	8 weeks	18.620	23.275
20981701	Fenix NTM nano laminate	Info below	L:201-250cm, W:100cm, H:73cm	8 weeks	23.276	29.095
20983001	Fenix NTM nano laminate	Info below	Ø:81-90cm, H:73cm (3 legs)	8 weeks	11.936	14.920
20983101	Fenix NTM nano laminate	Info below	Ø:91-100cm, H:73cm (3 legs)	8 weeks	12.532	15.665
20983201	Fenix NTM nano laminate	Info below	Ø:101-110cm, H:73cm (4 legs)	8 weeks	13.128	16.410
20983301	Fenix NTM nano laminate	Info below	Ø:111-120cm, H:73cm (4 legs)	8 weeks	14.324	17.905
20983401	Fenix NTM nano laminate	Info below	Ø:121-130cm, H:73cm (4 legs)	8 weeks	16.712	20.890
20983501	Fenix NTM nano laminate	Info below	Ø:131-140cm, H:73cm (4 legs)	8 weeks	19.100	23.875
20983601	Fenix NTM nano laminate	Info below	Ø:141-150cm, H:73cm (4 legs)	8 weeks	20.292	25.365
30310020	Cut out for cable management			6-8 weeks	592	740
30310021	Cable access set / Black			6-8 weeks	3.100	3.875
30310022	Cable access set / Silver			6-8 weeks	3.100	3.875

*Please note that the cable access is not preinstalled upon delivery

Table top materials

Oak Veneer
Forbo Linoleum
Fenix NTM nano laminate

Finishes and colours

Smoked, Clear or Black Lacquered
Black (4023), Grey (4132), Beige (4176)
Black (0720), White (0029),
Grey (0724), Beige (0719)

Material: Solid oak legs, MDF table top with either oak veneer, linoleum or laminate.

***Edge material:** Matching ABS, Clear Lacquered oak, Black Lacquered Oak or Smoked Lacquered Oak. Veneer table tops will have veneer edges. Linoleum and Laminate table tops will have matching ABS edges.

Legs: Choose between: Clear Lacquered oak, Smoked Lacquered or Black Lacquered Oak.

Adjustable gliders installed as standard.

Bevelled table top edge.

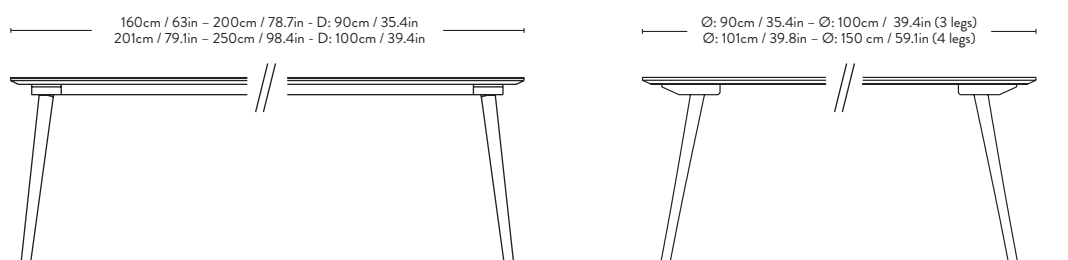

In Between ^{SK11 & SK12} Sami Kallio 2014



Item no.	Product	Size	Base	Model	Colli qty.	Lead time	Weight	PRICE EX. VAT (SEK)	PRICE INC. VAT (SEK)
20982000	Smoked Oiled Oak	Ø90cm	Black	SK11	1 pc	Stock item	46.60 kg	9.548	11.935
20982001			Bronzed	SK11	1 pc	Stock item	46.60 kg	9.548	11.935
20982092	Oiled Oak	Ø90cm	Black	SK11	1 pc	Stock item	46.60 kg	9.548	11.935
20982093			Bronzed	SK11	1 pc	Stock item	46.60 kg	9.548	11.935
20982094	Black Lacquered Oak	Ø90cm	Black	SK11	1 pc	Stock item	46.60 kg	9.548	11.935
20982095			Bronzed	SK11	1 pc	Stock item	46.60 kg	9.548	11.935
20982096	Oiled Walnut	Ø90cm	Black	SK11	1 pc	Stock item	46.60 kg	15.516	19.395
20982097			Bronzed	SK11	1 pc	Stock item	46.60 kg	15.516	19.395
20982100	Smoked Oiled Oak	Ø120cm	Black	SK12	1 pc	Stock item	68.50 kg	15.516	19.395
20982101			Bronzed	SK12	1 pc	Stock item	68.50 kg	15.516	19.395
20982192	Oiled Oak	Ø120cm	Black	SK12	1 pc	Stock item	68.50 kg	15.516	19.395
20982193			Bronzed	SK12	1 pc	Stock item	68.50 kg	15.516	19.395
20982194	Black Lacquered Oak	Ø120cm	Black	SK12	1 pc	Stock item	68.50 kg	15.516	19.395
20982195			Bronzed	SK12	1 pc	Stock item	68.50 kg	15.516	19.395
20982196	Oiled Walnut	Ø120cm	Black	SK12	1 pc	Stock item	68.50 kg	23.872	29.840
20982197			Bronzed	SK12	1 pc	Stock item	68.50 kg	23.872	29.840

Materials **Finishes and colours**

Table top Solid Oak, Solid Walnut
Center base Matt Black, Bronzed Metal

Felt gliders installed as standard.

Bevelled table top edge.

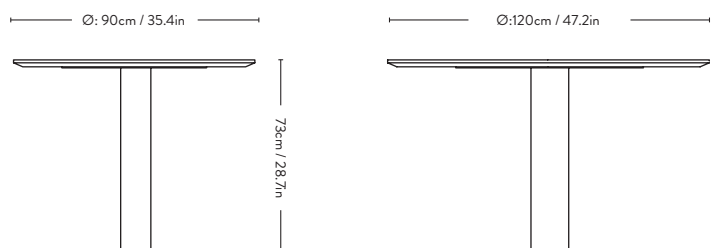

In Between Made to order

Sami Kallio

2014

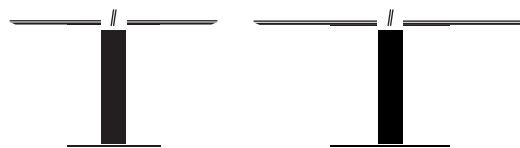

Item code	Table top	Model	Size	Lead time	PRICE EX. VAT (SEK)	PRICE INC. VAT (SEK)
20940100	Oak veneer, Forbo Linoleum	Info below	L:60cm, W:70cm, H:73cm	8 weeks	7.036	8.795
20941500	Oak veneer, Forbo Linoleum	Info below	L:90cm, W:90cm, H:73cm	8 weeks	11.936	14.920
20940300	Oak veneer, Forbo Linoleum	Info below	L:120cm, W:60cm, H:73cm**	8 weeks	11.696	14.620
20940400	Oak veneer, Forbo Linoleum	Info below	L:140cm, W:70cm, H:73cm**	8 weeks	12.528	15.660
20941600	Oak veneer, Forbo Linoleum	Info below	L:160-200cm, W:90cm, H:73cm**	8 weeks	11.216	14.020
20941700	Oak veneer, Forbo Linoleum	Info below	L:201-250cm, W:100cm, H:73cm**	8 weeks	12.532	15.665
20940800	Oak veneer, Forbo Linoleum	Info below	L:60cm, W:70cm, H:102cm	8 weeks	7.276	9.095
20940500	Oak veneer, Forbo Linoleum	Info below	L:120cm, W:60cm, H:102cm**	8 weeks	11.936	14.920
20940600	Oak veneer, Forbo Linoleum	Info below	L:140cm, W:70cm, H:102cm**	8 weeks	13.008	16.260
20940700	Oak veneer, Forbo Linoleum	Info below	Ø:60-70cm, H:102cm	8 weeks	7.276	9.095
20940200	Oak veneer, Forbo Linoleum	Info below	Ø:60-70cm, H:73cm	8 weeks	7.036	8.795
20943000	Oak veneer, Forbo Linoleum	Info below	Ø:80-90cm, H:73cm	8 weeks	10.740	13.425
20943100	Oak veneer, Forbo Linoleum	Info below	Ø:91-100cm, H:73cm	8 weeks	13.128	16.410
20943200	Oak veneer, Forbo Linoleum	Info below	Ø:101-110cm, H:73cm	8 weeks	13.724	17.155
20943300	Oak veneer, Forbo Linoleum	Info below	Ø:111-120cm, H:73cm	8 weeks	14.920	18.650
20943400	Oak veneer, Forbo Linoleum	Info below	Ø:121-130cm, H:73cm	8 weeks	17.904	22.380
20943500	Oak veneer, Forbo Linoleum	Info below	Ø:131-140cm, H:73cm	8 weeks	19.696	24.620
20943600	Oak veneer, Forbo Linoleum	Info below	Ø:141-150cm, H:73cm	8 weeks	20.888	26.110

Materials

Finishes and colours

MDF Table top

Oak Veneer in Smoked, Clear or Black Lacquer.
Forbo Linoleum in Black (4023), Grey (4132), Beige (4176).

Center base

Matt Black, Bronzed Metal

***Edge material:** Matching ABS, Clear Lacquered Oak, Black Lacquered Oak or Smoked Lacquered Oak. Veneer table tops will have veneer edges.
Linoleum and Laminate table tops will have matching ABS edges.

**Produced with two columns.

Felt gliders installed as standard.

Bevelled table top edge.

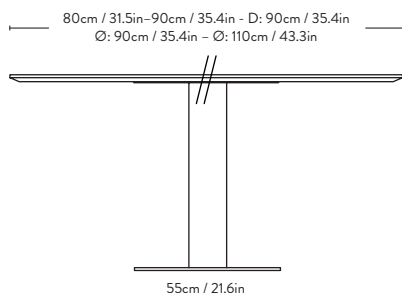

SK

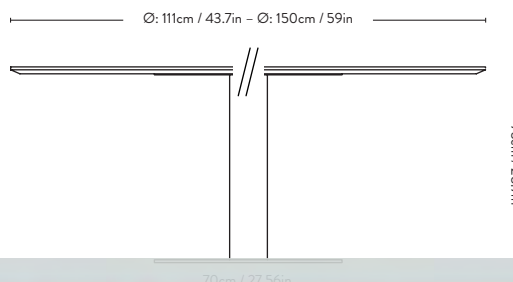
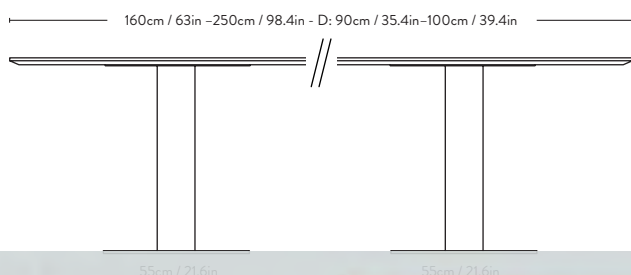

In Between Made to order Sami Kallio 2014

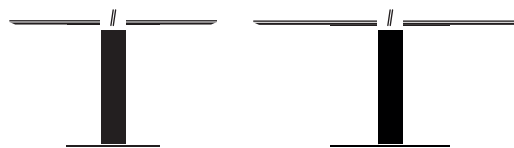

Item no.	Product	Model	Base	Lead time	PRICE EX. VAT (SEK)	PRICE INC. VAT (SEK)
20940101	Fenix NTM nano laminate	Info below	L:60cm, W:70cm, H:73cm	8 weeks	6.800	8.500
20941501	Fenix NTM nano laminate	Info below	L:90cm, W:90cm, H:73cm	8 weeks	11.936	14.920
20940301	Fenix NTM nano laminate	Info below	L:120cm, W:60cm, H:73cm**	8 weeks	10.976	13.720
20940401	Fenix NTM nano laminate	Info below	L:140cm, W:70cm, H:73cm**	8 weeks	12.052	15.065
20941601	Fenix NTM nano laminate	Info below	L:160-200cm, W:90cm, H:73cm**	8 weeks	19.100	23.875
20941701	Fenix NTM nano laminate	Info below	L:201-250cm, W:100cm, H:73cm**	8 weeks	23.276	29.095
20940801	Fenix NTM nano laminate	Info below	L:60cm, W:70cm, H:102cm	8 weeks	7.040	8.800
20940501	Fenix NTM nano laminate	Info below	L:120cm, W:60cm, H:102cm**	8 weeks	11.456	14.320
20940601	Fenix NTM nano laminate	Info below	L:140cm, W:70cm, H:102cm**	8 weeks	12.532	15.665
20940701	Fenix NTM nano laminate	Info below	Ø:60-70cm, H:102cm	8 weeks	7.040	8.800
20940201	Fenix NTM nano laminate	Info below	Ø:60-70cm, H:73cm	8 weeks	6.800	8.500
20943001	Fenix NTM nano laminate	Info below	Ø:80-90cm, H:73cm	8 weeks	10.144	12.680
20943101	Fenix NTM nano laminate	Info below	Ø:91-100cm, H:73cm	8 weeks	12.532	15.665
20943201	Fenix NTM nano laminate	Info below	Ø:101-110cm, H:73cm	8 weeks	13.128	16.410
20943301	Fenix NTM nano laminate	Info below	Ø:111-120cm, H:73cm	8 weeks	14.324	17.905
20943401	Fenix NTM nano laminate	Info below	Ø:121-130cm, H:73cm	8 weeks	16.712	20.890
20943501	Fenix NTM nano laminate	Info below	Ø:131-140cm, H:73cm	8 weeks	19.100	23.875
20943601	Fenix NTM nano laminate	Info below	Ø:141-150cm, H:73cm	8 weeks	20.292	25.365

Materials

Finishes and colours

MDF Table top Fenix NTM nano laminate in Black (0720), White (0029), Grey (0724), Beige (0719).

Center base Matt Black, Bronzed Metal

*Edge material: Matching ABS, Clear Lacquered Oak, Black Lacquered Oak or Smoked Lacquered Oak. Veneer table tops will have veneer edges.
Linoleum and Laminate table tops will have matching ABS edges.

**Produced with two columns.

Felt gliders installed as standard.

Bevelled table top edge.

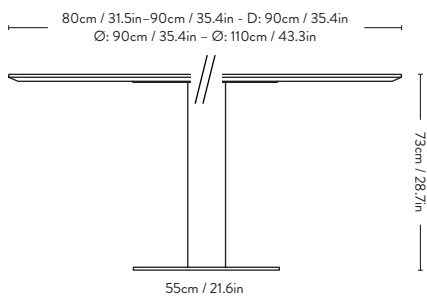

SK

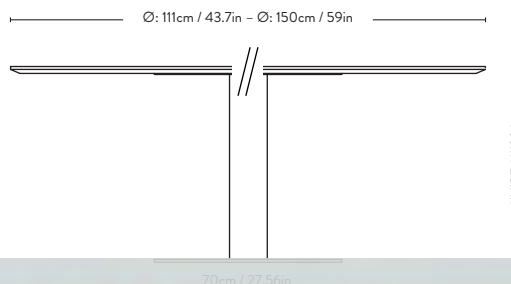
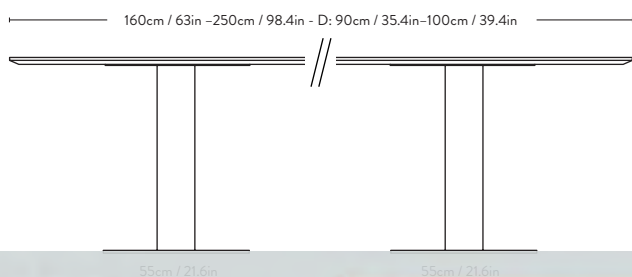

In Between ^{SK16-SK21} Sami Kallio 2014



Item no.	Product	Size	Base	Model	Colli qty.	Lead time	Weight	PRICE EX. VAT (SEK)	PRICE INC. VAT (SEK)
20920194	Nero Marquina	60x70cm	Black	SK16	1 pc	Stock item	45.50 kg	8.352	10.440
20920195			Bronzed	SK16	1 pc	Stock item	45.50 kg	8.352	10.440
20920130	Bianco Carrara	60x70cm	Black	SK16	1 pc	Stock item	45.50 kg	8.352	10.440
20920131			Bronzed	SK16	1 pc	Stock item	45.50 kg	8.352	10.440
20920394	Nero Marquina	Ø90cm	Black	SK18	1 pc	Stock item	71.00 kg	13.128	16.410
20920395			Bronzed	SK18	1 pc	Stock item	71.00 kg	13.128	16.410
20920330	Bianco Carrara	Ø90cm	Black	SK18	1 pc	Stock item	45.50 kg	13.128	16.410
20920331			Bronzed	SK18	1 pc	Stock item	45.50 kg	13.128	16.410
20920494	Nero Marquina	Ø120cm	Black	SK19	1 pc	Stock item	117.00 kg	21.488	26.860
20920495			Bronzed	SK19	1 pc	Stock item	117.00 kg	21.488	26.860
20920430	Bianco Carrara	Ø120cm	Black	SK19	1 pc	Stock item	117.00 kg	21.488	26.860
20920431			Bronzed	SK19	1 pc	Stock item	117.00 kg	21.488	26.860
20920594	Nero Marquina	Ø150cm	Black	SK20	1 pc	Stock item	152.00 kg	32.828	41.035
20920595			Bronzed	SK20	1 pc	Stock item	152.00 kg	32.828	41.035
20920530	Bianco Carrara	Ø150cm	Black	SK20	1 pc	Stock item	152.00 kg	32.828	41.035
20920531			Bronzed	SK20	1 pc	Stock item	152.00 kg	32.828	41.035
20920694	Nero Marquina	60x70cm - Bar table	Black	SK21	1 pc	Stock item	46.50 kg	8.592	10.740
20920695			Bronzed	SK21	1 pc	Stock item	46.50 kg	8.592	10.740
20920630	Bianco Carrara	60x70cm - Bar table	Black	SK21	1 pc	Stock item	46.50 kg	8.592	10.740
20920631			Bronzed	SK21	1 pc	Stock item	46.50 kg	8.592	10.740

Felt gliders installed as standard.

Bevelled table top edge.

Polyester marble coating available with a 45% upcharge and with 6-8 weeks leadtime.

Materials Colour

Table top Nero Marquina, Bianco Carrara
Center base Black, Bronzed metal

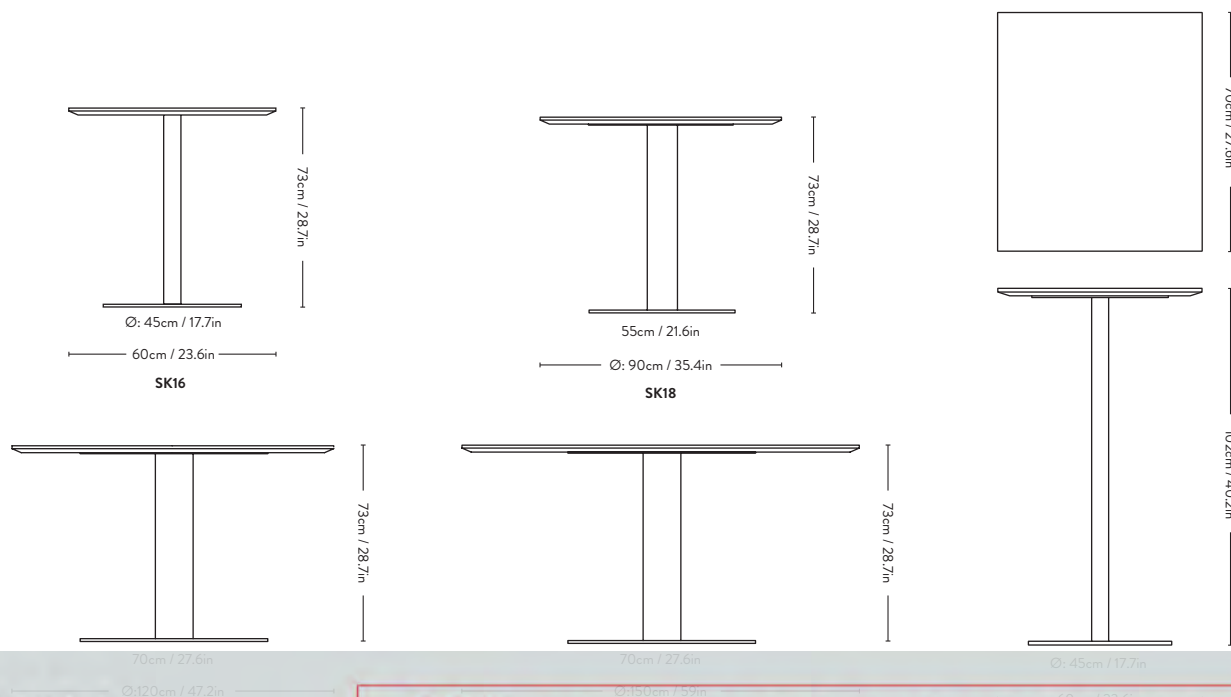

In Between ^{Made to order} Sami Kallio 2014



Item no.	Product	Table top size	Center base size	Base	Lead time	PRICE EX. VAT (SEK)	PRICE INC. VAT (SEK)
20920100	Nero Marquina, Bianco Carrara	Ø60cm	Ø45cm / 5cm	Black, Bronzed	6-8 weeks	8.352	10.440
20920200	Nero Marquina, Bianco Carrara	Ø70cm	Ø45cm / 5cm	Black, Bronzed	6-8 weeks	9.548	11.935
20920300	Nero Marquina, Bianco Carrara	Ø80cm	Ø55cm / 10cm	Black, Bronzed	6-8 weeks	11.336	14.170
20920400	Nero Marquina, Bianco Carrara	Ø100cm	Ø55cm / 10cm	Black, Bronzed	6-8 weeks	14.324	17.905
20920500	Nero Marquina, Bianco Carrara	Ø110cm	Ø55cm / 10cm	Black, Bronzed	6-8 weeks	16.112	20.140
20920600	Nero Marquina, Bianco Carrara	Ø130cm	Ø70cm / 14cm	Black, Bronzed	6-8 weeks	25.068	31.335
20920700	Nero Marquina, Bianco Carrara	Ø140cm	Ø70cm / 14cm	Black, Bronzed	6-8 weeks	28.652	35.815
20920800	Nero Marquina, Bianco Carrara	80x80cm	Ø70cm / 14cm	Black, Bronzed	6-8 weeks	11.336	14.170

Materials Colour

Table top	Nero Marquina, Bianco Carrara
Center base	Black, Bronzed metal

Felt gliders installed as standard.

Bevelled table top edge.

Polyester marble coating available with a 45% upcharge.

In Between SK16-SK17 & SK21-SK22 Sami Kallio 2014



Item no.	Product	Size	Base	Model	Colli qty.	Lead time	Weight	PRICE EX. VAT (SEK)	PRICE INC. VAT (SEK)
20946094	Black Fenix Nano Laminate	60x70cm	Black	SK16	1 pc	Stock item	21.00 kg	5.604	7.005
20946096			Bronzed	SK16	1 pc	Stock item	21.00 kg	5.604	7.005
20946194	Black Fenix Nano Laminate	Ø60cm	Black	SK17	1 pc	Stock item	21.00 kg	5.604	7.005
20946195			Bronzed	SK17	1 pc	Stock item	21.00 kg	5.604	7.005
20946594	Black Fenix Nano Laminate	60x70cm - Bar table	Black	SK21	1 pc	Stock item	22.00 kg	5.844	7.305
20946595			Bronzed	SK21	1 pc	Stock item	22.00 kg	5.844	7.305
20946694	Black Fenix Nano Laminate	Ø60cm - Bar table	Black	SK22	1 pc	Stock item	22.00 kg	5.844	7.305
20946695			Bronzed	SK22	1 pc	Stock item	22.00 kg	5.844	7.305

Materials Colour

Table top Fenix Nano Laminate
Center base Black, Bronzed metal

Felt gliders installed as standard.

Bevelled table top edge.

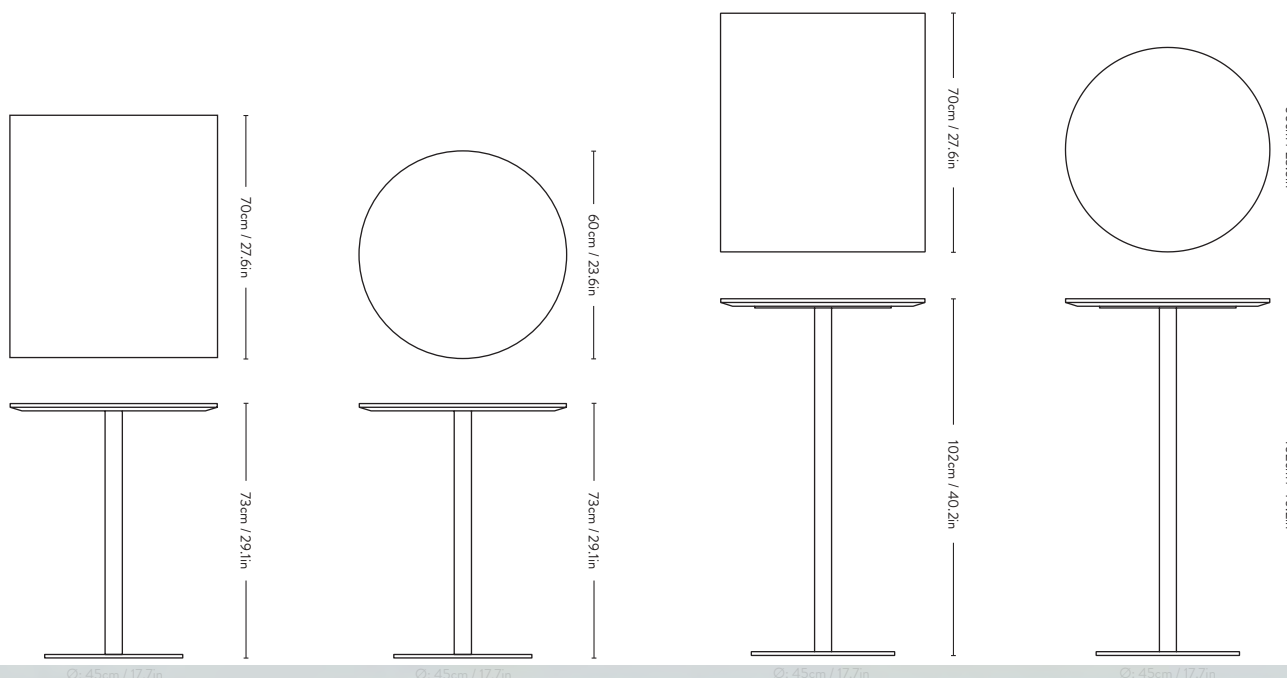

22% RABATT SKA DRAS AV PÅ ANGIVNA PRISER

Patch ^{HW1} Hee Welling 2020



Item no.	Product	Model	Colli qty.	Lead time	Weight	PRICE EX. VAT (SEK)	PRICE INC. VAT (SEK)
20930092	Oiled Oak w. Fenix 0748 Beige Arizona & Brass	HW1	1 pc	Stock item	73.50 kg	27.456	34.320
20930000	Smoked Oak w. Fenix 0718 Griogio Londra & Brass	HW1	1 pc	Stock item	73.50 kg	27.456	34.320
20930096	Walnut w. Fenix 0749 Cacao Orinoco & Brass	HW1	1 pc	Stock item	73.50 kg	31.040	38.800

Frame **Table top**

Solid wood Fenix NTM nano laminate

Frame **Edges**

Oak Oiled Oak, Smoked Oiled Oak
Walnut Oiled Walnut

Material: Nano laminated MDF tabletop. Extension leaves with veneered and chamfered edges. Solid wood frame and legs.

Brass fittings.

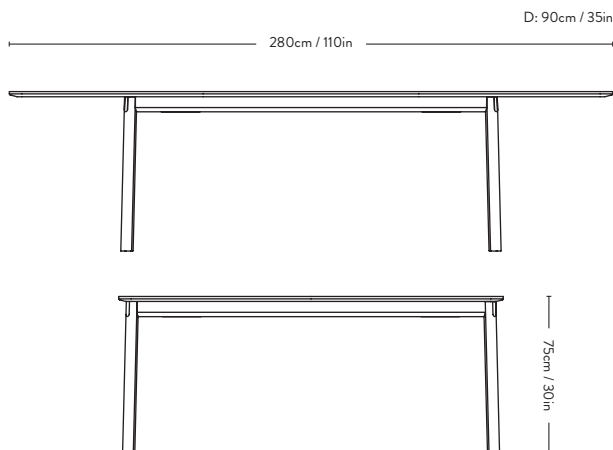

Patch ^{HW2} Hee Welling 2020



Item no.	Product	Model	Colli qty.	Lead time	Weight	PRICE EX. VAT (SEK)	PRICE INC. VAT (SEK)
20930192	Oiled Oak w. Fenix 0748 Beige Arizona & Brass	HW2	1 pc	Stock item	89.50 kg	29.844	37.305
20930100	Smoked Oak w. Fenix 0718 Griogio Londra & Brass	HW2	1 pc	Stock item	89.50 kg	29.844	37.305
20930196	Walnut w. Fenix 0749 Cacao Orinoco & Brass	HW2	1 pc	Stock item	89.50 kg	33.428	41.785

Frame **Table top**

Solid wood Fenix NTM nano laminate

Frame **Edges**

Oak Oiled Oak, Smoked Oiled Oak
Walnut Oiled Walnut

Material: Nano laminated MDF tabletop. Extension leaves with veneered and chamfered edges. Solid wood frame and legs.

Brass fittings.

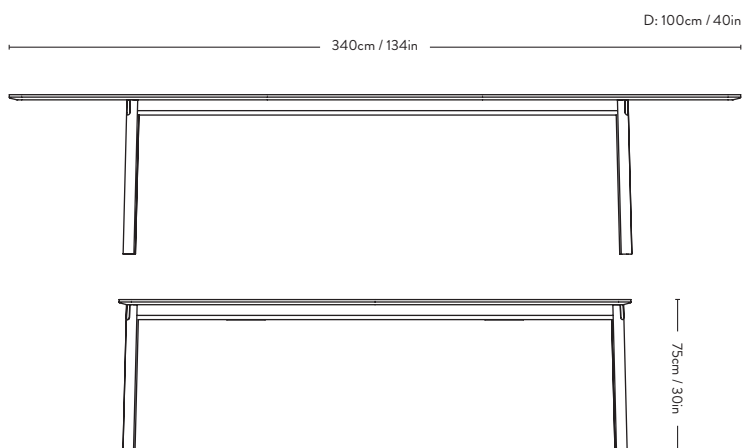

Drip ^{HW58} Hee Welling 2021



Item no.	Table top	Size	Base	Model	Colli qty.	Lead time	Weight	PRICE EX. VAT (SEK)	PRICE INC. VAT (SEK)
18001101 18001106	Nero Ingo Fenix Nano Laminate (0720)	140 x 80cm	Black Bronzed	HW58	1 pc	Stock item	25.00 kg	11.336	14.170
18001150 18001156	Smokey Blue Forbo Linoleum (4179) & Dark Blue Ostermann (043.5984), Glossy Edge	140 x 80cm	Black Bronzed	HW58	1 pc	10 -12 weeks	25.00 kg	11.932	14.915
18001151 18001157	Pearl Forbo Linoleum (4157) & Soft Yellow Rehau (78162), Glossy Edge	140 x 80cm	Black Bronzed	HW58	1 pc	10 -12 weeks	25.00 kg	11.932	14.915
18001111 18001112	Burgundy Forbo Linoleum (4154) & Red Ostermann (043.4110), Glossy Edge	140 x 80cm	Black Bronzed	HW58	1 pc	10 -12 weeks	25.00 kg	11.932	14.915
18001152 18001158	Castoro Ottawa Fenix Nano Laminate (0720) & Light Brown Rehau (V1272), Glossy Edge	140 x 80cm	Black Bronzed	HW58	1 pc	10 -12 weeks	25.00 kg	13.128	16.410
18001153 18001159	Cacao Orinoco Fenix Nano Laminate (0749) & Grey Brown Rehau (71038), Glossy Edge	140 x 80cm	Black Bronzed	HW58	1 pc	10 -12 weeks	25.00 kg	13.128	16.410
18001154 18001160	Verde Comodoro Fenix Nano Laminate (0750) & Grey Rehau (97959), Glossy Edge	140 x 80cm	Black Bronzed	HW58	1 pc	10 -12 weeks	25.00 kg	13.128	16.410
18001155 18001161	Azzurro Naxos Fenix Nano Laminate (0771) & Light Blue Rehau (77193), Glossy Edge	140 x 80cm	Black Bronzed	HW58	1 pc	10 -12 weeks	25.00 kg	13.128	16.410
18001121	Linoleum - all colours	140 x 80cm	Black Bronzed	HW58	1 pc	10 -12 weeks	25.00 kg	11.932	14.915
18001131	Nano Laminate - all colours	140 x 80cm	Black Bronzed	HW58	1 pc	10 -12 weeks	25.00 kg	13.128	16.410
18001141	Veneer - oak or walnut	140 x 80cm	Black Bronzed	HW58	1 pc	10 -12 weeks	25.00 kg	13.128	16.410
30310020	Cut out for cable management					10 -12 weeks		592	740
30310021	Cable access set / Black					10 -12 weeks		3.100	3.875
30310022	Cable access set / Silver					10 -12 weeks		3.100	3.875



EU Ecolabel certified, validating high standards of durability, circular design, and responsible use of chemicals. Please contact our sales team for a list of EU Ecolabel compliant combinations.

Material: Aluminium base, MDF tabletop with Fenix Nano laminate, Forbo linoleum or wood veneer.

Nero Ingo is produced with a matching high gloss edgeband.

All other colours are produced with a matching ABS edgeband. Wood veneer is produced with a matching edgeband.

All table tops and edgebands can be mixed and matched
Plastic gliders installed as standard.
Castors are available upon request.

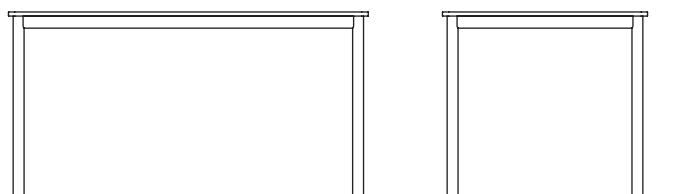

Drip ^{HW59} Hee Welling 2021



Item no.	Table top	Size	Base	Model	Colli qty.	Lead time	Weight	PRICE EX. VAT (SEK)	PRICE INC. VAT (SEK)
18001201	Nero Ingo Fenix Nano Laminate (0720)	190 x 80cm	Black	HW59	1 pc	Stock item	32.50 kg	12.528	15.660
18001206			Bronzed					12.528	15.660
18001250	Smokey Blue Forbo Linoleum (4179) & Dark	190 x 80cm	Black	HW59	1 pc	10 -12 weeks	32.50 kg	13.724	17.155
18001256	Blue Ostermann (043.5984), Glossy Edge		Bronzed					13.724	17.155
18001251	Pearl Forbo Linoleum (4157) & Soft Yellow	190 x 80cm	Black	HW59	1 pc	10 -12 weeks	32.50 kg	13.724	17.155
18001257	Rehau (78162), Glossy Edge		Bronzed					13.724	17.155
18001211	Burgundy Forbo Linoleum (4154) & Red	190 x 80cm	Black	HW59	1 pc	10 -12 weeks	32.50 kg	13.724	17.155
18001212	Ostermann (043.4110), Glossy Edge		Bronzed					13.724	17.155
18001252	Castoro Ottawa Fenix Nano Laminate (0720) &	190 x 80cm	Black	HW59	1 pc	10 -12 weeks	32.50 kg	14.920	18.650
18001258	Light Brown Rehau (V1272), Glossy Edge		Bronzed					14.920	18.650
18001253	Cacao Orinoco Fenix Nano Laminate (0749) &	190 x 80cm	Black	HW59	1 pc	10 -12 weeks	32.50 kg	14.920	18.650
18001259	Grey Brown Rehau (71038), Glossy Edge		Bronzed					14.920	18.650
18001254	Verde Comodoro Fenix Nano Laminate (0750) &	190 x 80cm	Black	HW59	1 pc	10 -12 weeks	32.50 kg	14.920	18.650
18001260	& Grey Rehau (97959), Glossy Edge		Bronzed					14.920	18.650
18001255	Azzurro Naxos Fenix Nano Laminate (0771) &	190 x 80cm	Black	HW59	1 pc	10 -12 weeks	32.50 kg	14.920	18.650
18001261	Light Blue Rehau (77193), Glossy Edge		Bronzed					14.920	18.650
18001221	Linoleum - all colours	190 x 80cm	Black	HW59	1 pc	10 -12 weeks	32.50 kg	13.724	17.155
			Bronzed					13.724	17.155
18001231	Nano Laminate - all colours	190 x 80cm	Black	HW59	1 pc	10 -12 weeks	32.50 kg	14.920	18.650
			Bronzed					14.920	18.650
18001241	Veneer - oak or walnut	190 x 80cm	Black	HW59	1 pc	10 -12 weeks	32.50 kg	14.920	18.650
			Bronzed					14.920	18.650
30310020	Cut out for cable management					10 -12 weeks		592	740
30310021	Cable access set / Black					10 -12 weeks		3.100	3.875
30310022	Cable access set / Silver					10 -12 weeks		3.100	3.875



EU Ecolabel certified, validating high standards of durability, circular design, and responsible use of chemicals. Please contact our sales team for a list of EU Ecolabel compliant combinations.

Material: Aluminium base, MDF tabletop with Fenix Nano laminate, Forbo linoleum or wood veneer.

Nero Ingo is produced with a matching high gloss edgeband.

All other colours are produced with a matching ABS edgeband. Wood veneer is produced with a matching edgeband.

All table tops and edgebands can be mixed and matched
Plastic gliders installed as standard.
Castors are available upon request.

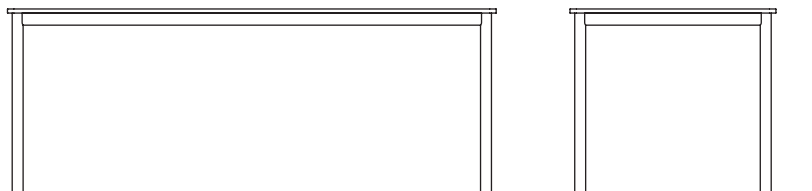

Drip HW60 Hee Welling 2021



Item no.	Table top	Size	Base	Model	Colli qty.	Lead time	Weight	PRICE EX. VAT (SEK)	PRICE INC. VAT (SEK)
18001301 18001306	Nero Ingo Fenix Nano Laminate (0720)	250 x 100 cm	Black Bronzed	HW60	1 pc	Stock item	49.00 kg	15.516 15.516	19.395 19.395
18001350 18001356	Smokey Blue Forbo Linoleum (4179) & Dark Blue Ostermann (043.5984), Glossy Edge	250 x 100 cm	Black Bronzed	HW60	1 pc	10 -12 weeks	49.00 kg	18.500 18.500	23.125 23.125
18001351 18001357	Pearl Forbo Linoleum (4157) & Soft Yellow Rehau (78162), Glossy Edge	250 x 100 cm	Black Bronzed	HW60	1 pc	10 -12 weeks	49.00 kg	18.500 18.500	23.125 23.125
18001311 18001312	Burgundy Forbo Linoleum (4154) & Red Ostermann (043.4110), Glossy Edge	250 x 100 cm	Black Bronzed	HW60	1 pc	10 -12 weeks	49.00 kg	18.500 18.500	23.125 23.125
18001352 18001358	Castoro Ottawa Fenix Nano Laminate (0720) & Light Brown Rehau (V1272), Glossy Edge	250 x 100 cm	Black Bronzed	HW60	1 pc	10 -12 weeks	49.00 kg	20.292 20.292	25.365 25.365
18001353 18001359	Cacao Orinoco Fenix Nano Laminate (0749) & Grey Brown Rehau (71038), Glossy Edge	250 x 100 cm	Black Bronzed	HW60	1 pc	10 -12 weeks	49.00 kg	20.292 20.292	25.365 25.365
18001354 18001360	Verde Comodoro Fenix Nano Laminate (0750) & Grey Rehau (97959), Glossy Edge	250 x 100 cm	Black Bronzed	HW60	1 pc	10 -12 weeks	49.00 kg	20.292 20.292	25.365 25.365
18001355 18001361	Azzurro Naxos Fenix Nano Laminate (0771) & Light Blue Rehau (77193), Glossy Edge	250 x 100 cm	Black Bronzed	HW60	1 pc	10 -12 weeks	49.00 kg	20.292 20.292	25.365 25.365
18001321	Linoleum - all colours	250 x 100 cm	Black Bronzed	HW60	1 pc	10 -12 weeks	49.00 kg	18.500 18.500	23.125 23.125
18001331	Nano Laminate - all colours	250 x 100 cm	Black Bronzed	HW60	1 pc	10 -12 weeks	49.00 kg	20.292 20.292	25.365 25.365
18001341	Veneer - oak or walnut	250 x 100 cm	Black Bronzed	HW60	1 pc	10 -12 weeks	49.00 kg	20.292 20.292	25.365 25.365
30310020	Cut out for cable management					10 -12 weeks		592	740
30310021	Cable access set / Black					10 -12 weeks		3.100	3.875
30310022	Cable access set / Silver					10 -12 weeks		3.100	3.875



EU Ecolabel certified, validating high standards of durability, circular design, and responsible use of chemicals. Please contact our sales team for a list of EU Ecolabel compliant combinations.

Material: Aluminium base, MDF tabletop with Fenix Nano laminate, Forbo linoleum or wood veneer.

Nero Ingo is produced with a matching high gloss edgeband.

All other colours are produced with a matching ABS edgeband. Wood veneer is produced with a matching edgeband.

All table tops and edgebands can be mixed and matched
Plastic gliders installed as standard.
Castors are available upon request.



Drip ^{HW61} Hee Welling 2021



Item code	Table top	Size	Model	Base	Colli qty.	Lead time	Weight	PRICE EX. VAT (SEK)	PRICE INC. VAT (SEK)
18001401	Nero Ingo Fenix Nano Laminate (0720)	190 x 50 x 95 cm	HW61	Black	1 pc	Stock item	26.80 kg	17.308	21.635
18001406				Bronzed				17.308	21.635
18001450	Smokey Blue Forbo Linoleum (4179) & Dark Blue Ostermann (043.5984), Glossy Edge	190 x 50 x 95 cm	HW61	Black	1 pc	10 -12 weeks	26.80 kg	19.100	23.875
18001456				Bronzed				19.100	23.875
18001451	Pearl Forbo Linoleum (4157) & Soft Yellow Rehau (78162), Glossy Edge	190 x 50 x 95 cm	HW61	Black	1 pc	10 -12 weeks	26.80 kg	19.100	23.875
18001457				Bronzed				19.100	23.875
18001411	Burgundy Forbo Linoleum (4154) & Red Ostermann (043.4110), Glossy Edge	190 x 50 x 95 cm	HW61	Black	1 pc	10 -12 weeks	26.80 kg	19.100	23.875
18001412				Bronzed				19.100	23.875
18001452	Castoro Ottawa Fenix Nano Laminate (0720) & Light Brown Rehau (V1272), Glossy Edge	190 x 50 x 95 cm	HW61	Black	1 pc	10 -12 weeks	26.80 kg	20.292	25.365
18001458				Bronzed				20.292	25.365
18001453	Cacao Orinoco Fenix Nano Laminate (0749) & Grey Brown Rehau (71038), Glossy Edge	190 x 50 x 95 cm	HW61	Black	1 pc	10 -12 weeks	26.80 kg	20.292	25.365
18001459				Bronzed				20.292	25.365
18001454	Verde Comodoro Fenix Nano Laminate (0750) & Grey Rehau (97959), Glossy Edge	190 x 50 x 95 cm	HW61	Black	1 pc	10 -12 weeks	26.80 kg	20.292	25.365
18001460				Bronzed				20.292	25.365
18001455	Azzurro Naxos Fenix Nano Laminate (0771) & Light Blue Rehau (77193), Glossy Edge	190 x 50 x 95 cm	HW61	Black	1 pc	10 -12 weeks	26.80 kg	20.292	25.365
18001461				Bronzed				20.292	25.365
18001421	Linoleum - all colours	190 x 50 x 95 cm	HW61	Black	1 pc	10-12 weeks	26.80 kg	19.100	23.875
				Bronzed				19.100	23.875
18001431	Nano Laminate - all colours	190 x 50 x 95 cm	HW61	Black	1 pc	10-12 weeks	26.80 kg	20.292	25.365
				Bronzed				20.292	25.365
18001441	Veneer - oak or walnut	190 x 50 x 95 cm	HW61	Black	1 pc	10-12 weeks	26.80 kg	20.292	25.365
				Bronzed				20.292	25.365
30310020	Cut out for cable management					10 -12 weeks		592	740
30310021	Cable pit set / Black					10 -12 weeks		3.100	3.875
30310022	Cable pit set / Silver					10 -12 weeks		3.100	3.875



EU Ecolabel certified, validating high standards of durability, circular design, and responsible use of chemicals. Please contact our sales team for a list of EU Ecolabel compliant combinations.

Material: Steel and aluminium base, MDF tabletop with Fenix Nano laminate, Forbo linoleum or wood veneer.

Nero Ingo is produced with a matching high gloss edgeband.

All other colours are produced with a matching ABS edgeband. Wood veneer is produced with a matching edgeband.

All table tops and edgebands can be mixed and matched
Plastic gliders installed as standard.
Castors are available upon request.

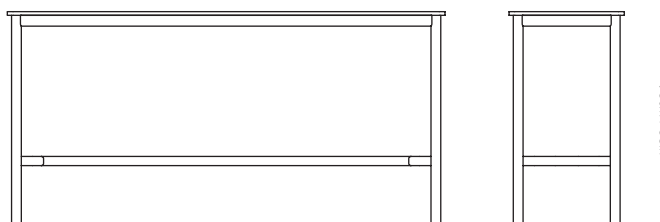

Drip ^{HW62} Hee Welling 2021



Item code	Table top	Size	Model	Base	Colli qty.	Lead time	Weight	PRICE EX. VAT (SEK)	PRICE INC. VAT (SEK)
18001501 18001506	Nero Ingo Fenix Nano Laminate (0720)	190 x 80 x 95 cm	HW62	Black Bronzed	1 pc	Stock item	36.00 kg	17.904	22.380
18001550 18001556	Smokey Blue Forbo Linoleum (4179) & Dark Blue Ostermann (043.5984), Glossy Edge	190 x 80 x 95 cm	HW62	Black Bronzed	1 pc	10-12 weeks	36.00 kg	19.100	23.875
18001551 18001557	Pearl Forbo Linoleum (4157) & Soft Yellow Rehau (78162), Glossy Edge	190 x 80 x 95 cm	HW62	Black Bronzed	1 pc	10-12 weeks	36.00 kg	19.100	23.875
18001511 18001512	Burgundy Forbo Linoleum (4154) & Red Ostermann (043.4110), Glossy Edge	190 x 80 x 95 cm	HW62	Black Bronzed	1 pc	10-12 weeks	36.00 kg	19.100	23.875
18001552 18001558	Castoro Ottawa Fenix Nano Laminate (0720) & Light Brown Rehau (V1272), Glossy Edge	190 x 80 x 95 cm	HW62	Black Bronzed	1 pc	10-12 weeks	36.00 kg	20.292	25.365
18001553 18001559	Cacao Orinoco Fenix Nano Laminate (0749) & Grey Brown Rehau (71038), Glossy Edge	190 x 80 x 95 cm	HW62	Black Bronzed	1 pc	10-12 weeks	36.00 kg	20.292	25.365
18001554 18001560	Verde Comodoro Fenix Nano Laminate (0750) & Grey Rehau (97959), Glossy Edge	190 x 80 x 95 cm	HW62	Black Bronzed	1 pc	10-12 weeks	36.00 kg	20.292	25.365
18001555 18001561	Azzurro Naxos Fenix Nano Laminate (0771) & Light Blue Rehau (77193), Glossy Edge	190 x 80 x 95 cm	HW62	Black Bronzed	1 pc	10-12 weeks	36.00 kg	20.292	25.365
18001521	Linoleum - all colours	190 x 80 x 95 cm	HW62	Black Bronzed	1 pc	10-12 weeks	36.00 kg	19.100	23.875
18001531	Nano Laminate - all colours	190 x 80 x 95 cm	HW62	Black Bronzed	1 pc	10-12 weeks	36.00 kg	20.292	25.365
18001541	Veneer - oak or walnut	190 x 80 x 95 cm	HW62	Black Bronzed	1 pc	10-12 weeks	36.00 kg	20.292	25.365
30310020	Cut out for cable management					10 -12 weeks		592	740
30310021	Cable pit set / Black					10 -12 weeks		3.100	3.875
30310022	Cable pit set / Silver					10 -12 weeks		3.100	3.875



EU Ecolabel certified, validating high standards of durability, circular design, and responsible use of chemicals. Please contact our sales team for a list of EU Ecolabel compliant combinations.

Material: Aluminium base, MDF tabletop with Fenix Nano laminate, Forbo linoleum or wood veneer.

Nero Ingo is produced with a matching high gloss edgeband.

All other colours are produced with a matching ABS edgeband. Wood veneer is produced with a matching edgeband.

All table tops and edgebands can be mixed and matched
Plastic gliders installed as standard.
Castors are available upon request.

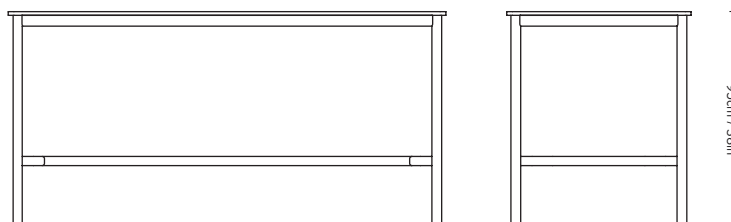

Drip ^{HW63} Hee Welling 2021



Item code	Table top	Size	Model	Base	Colli qty.	Lead time	Weight	PRICE EX. VAT (SEK)	PRICE INC. VAT (SEK)
18001601 18001606	Nero Ingo Fenix Nano Laminate (0720)	190 x 50 x 105 cm	HW63	Black Bronzed	1 pc	Stock item	28.00 kg	17.308	21.635
18001650 18001656	Smokey Blue Forbo Linoleum (4179) & Dark Blue Ostermann (043.5984), Glossy Edge	190 x 50 x 105 cm	HW63	Black Bronzed	1 pc	10-12 weeks	28.00 kg	19.100	23.875
18001651 18001657	Pearl Forbo Linoleum (4157) & Soft Yellow Rehau (78162), Glossy Edge	190 x 50 x 105 cm	HW63	Black Bronzed	1 pc	10-12 weeks	28.00 kg	19.100	23.875
18001611 18001612	Burgundy Forbo Linoleum (4154) & Red Ostermann (043.4110), Glossy Edge	190 x 50 x 105 cm	HW63	Black Bronzed	1 pc	10-12 weeks	28.00 kg	19.100	23.875
18001652 18001658	Castoro Ottawa Fenix Nano Laminate (0720) & Light Brown Rehau (V1272), Glossy Edge	190 x 50 x 105 cm	HW63	Black Bronzed	1 pc	10-12 weeks	28.00 kg	20.292	25.365
18001653 18001659	Cacao Orinoco Fenix Nano Laminate (0749) & Grey Brown Rehau (71038), Glossy Edge	190 x 50 x 105 cm	HW63	Black Bronzed	1 pc	10-12 weeks	28.00 kg	20.292	25.365
18001654 18001660	Verde Comodoro Fenix Nano Laminate (0750) & Grey Rehau (97959), Glossy Edge	190 x 50 x 105 cm	HW63	Black Bronzed	1 pc	10-12 weeks	28.00 kg	20.292	25.365
18001655 18001661	Azzurro Naxos Fenix Nano Laminate (0771) & Light Blue Rehau (77193), Glossy Edge	190 x 50 x 105 cm	HW63	Black Bronzed	1 pc	10-12 weeks	28.00 kg	20.292	25.365
18001621	Linoleum - all colours	190 x 50 x 105 cm	HW63	Black Bronzed	1 pc	10-12 weeks	28.00 kg	19.100	23.875
18001631	Nano Laminate - all colours	190 x 50 x 105 cm	HW63	Black Bronzed	1 pc	10-12 weeks	28.00 kg	20.292	25.365
18001641	Veneer - oak or walnut	190 x 50 x 105 cm	HW63	Black, Bronzed	1 pc	10-12 weeks	28.00 kg	20.292	25.365
30310020	Cut out for cable management					10 -12 weeks		592	740
30310021	Cable pit set / Black					10 -12 weeks		3.100	3.875
30310022	Cable pit set / Silver					10 -12 weeks		3.100	3.875



EU Ecolabel certified, validating high standards of durability, circular design, and responsible use of chemicals. Please contact our sales team for a list of EU Ecolabel compliant combinations.

Material: Aluminium base, MDF tabletop with Fenix Nano laminate, Forbo linoleum or wood veneer.

Nero Ingo is produced with a matching high gloss edgeband.

All other colours are produced with a matching ABS edgeband. Wood veneer is produced with a matching edgeband.

All table tops and edgebands can be mixed and matched
Plastic gliders installed as standard.
Castors are available upon request.

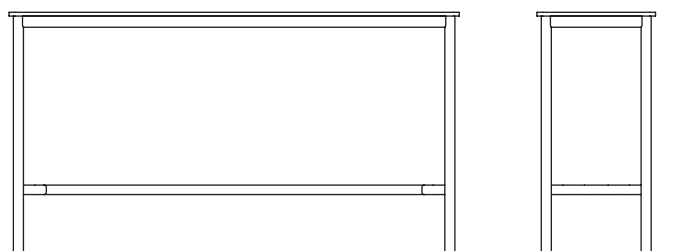

190cm / 76in 50cm / 20in
22% RABATT SKA DRAS AV PÅ ANGIVNA PRISER

Drip HW64 Hee Welling 2021



Item code	Table top	Size	Model	Base	Colli qty.	Lead time	Weight	PRICE EX. VAT (SEK)	PRICE INC. VAT (SEK)
18001701 18001706	Nero Ingo Fenix Nano Laminate (0720)	190 x 80 x 105 cm	HW64	Black Bronzed	1 pc	Stock item	37.20 kg	17.904	22.380
18001750 18001756	Smokey Blue Forbo Linoleum (4179) & Dark Blue Ostermann (043.5984), Glossy Edge	190 x 80 x 105 cm	HW64	Black Bronzed	1	10-12 weeks	37.20 kg	19.100	23.875
18001751 18001757	Pearl Forbo Linoleum (4157) & Soft Yellow Rehau (78162), Glossy Edge	190 x 80 x 105 cm	HW64	Black Bronzed	1	10-12 weeks	37.20 kg	19.100	23.875
18001711 18001712	Burgundy Forbo Linoleum (4154) & Red Ostermann (043.4110), Glossy Edge	190 x 80 x 105 cm	HW64	Black Bronzed	1	10-12 weeks	37.20 kg	19.100	23.875
18001752 18001758	Castoro Ottawa Fenix Nano Laminate (0720) & Light Brown Rehau (V1272), Glossy Edge	190 x 80 x 105 cm	HW64	Black Bronzed	1	10-12 weeks	37.20 kg	20.292	25.365
18001753 18001759	Cacao Orinoco Fenix Nano Laminate (0749) & Grey Brown Rehau (71038), Glossy Edge	190 x 80 x 105 cm	HW64	Black Bronzed	1	10-12 weeks	37.20 kg	20.292	25.365
18001754 18001760	Verde Comodoro Fenix Nano Laminate (0750) & Grey Rehau (97959), Glossy Edge	190 x 80 x 105 cm	HW64	Black Bronzed	1	10-12 weeks	37.20 kg	20.292	25.365
18001755 18001761	Azzurro Naxos Fenix Nano Laminate (0771) & Light Blue Rehau (77193), Glossy Edge	190 x 80 x 105 cm	HW64	Black Bronzed	1	10-12 weeks	37.20 kg	20.292	25.365
18001721	Linoleum - all colours	190 x 80 x 105 cm	HW64	Black Bronzed	1 pc	10-12 weeks	37.20 kg	19.100	23.875
18001731	Nano Laminate - all colours	190 x 80 x 105 cm	HW64	Black Bronzed	1 pc	10-12 weeks	37.20 kg	20.292	25.365
18001741	Veneer - oak or walnut	190 x 80 x 105 cm	HW64	Black Bronzed	1 pc	10-12 weeks	37.20 kg	20.292	25.365
30310020	Cut out for cable management					10 -12 weeks		592	740
30310021	Cable pit set / Black					10 -12 weeks		3.100	3.875
30310022	Cable pit set / Silver					10 -12 weeks		3.100	3.875



EU Ecolabel certified, validating high standards of durability, circular design, and responsible use of chemicals. Please contact our sales team for a list of EU Ecolabel compliant combinations.

Material: Steel and aluminium base, MDF tabletop with Fenix Nano laminate, Forbo linoleum or wood veneer.

Nero Ingo is produced with a matching high gloss edgeband.

All other colours are produced with a matching ABS edgeband. Wood veneer is produced with a matching edgeband.

All table tops and edgebands can be mixed and matched
Plastic gliders installed as standard.
Castors are available upon request.

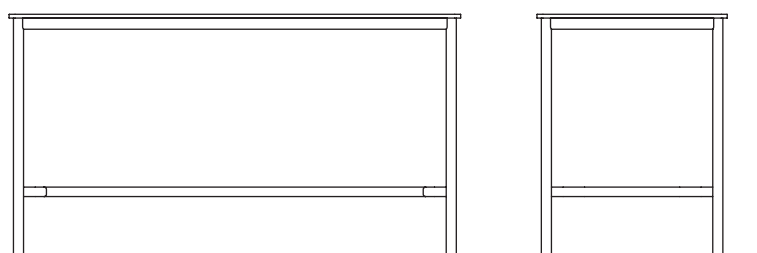

Drip^{HW111} Hee Welling 2021



Item code	Table top	Size	Model	Base	Colli qty.	Lead time	Weight	PRICE EX. VAT (SEK)	PRICE INC. VAT (SEK)
18004201 18004206	Nero Ingo Fenix Nano Laminate (0720)	140 x 50 x 95 cm	HW111	Black Bronzed	1 pc	Stock item	22.90 kg	16.712	20.890
18004250 18004256	Smokey Blue Forbo Linoleum (4179) & Dark Blue Ostermann (043.5984), Glossy Edge	140 x 50 x 95 cm	HW111	Black Bronzed	1 pc	10-12 weeks	22.90 kg	17.904	22.380
18004251 18004257	Pearl Forbo Linoleum (4157) & Soft Yellow Rehau (78162), Glossy Edge	140 x 50 x 95 cm	HW111	Black Bronzed	1 pc	10-12 weeks	22.90 kg	17.904	22.380
18004211 18004212	Burgundy Forbo Linoleum (4154) & Red Ostermann (043.4110), Glossy Edge	140 x 50 x 95 cm	HW111	Black Bronzed	1 pc	10-12 weeks	22.90 kg	17.904	22.380
18004252 18004258	Castoro Ottawa Fenix Nano Laminate (0720) & Light Brown Rehau (V1272), Glossy Edge	140 x 50 x 95 cm	HW111	Black Bronzed	1 pc	10-12 weeks	22.90 kg	19.100	23.875
18004253 18004259	Cacao Orinoco Fenix Nano Laminate (0749) & Grey Brown Rehau (71038), Glossy Edge	140 x 50 x 95 cm	HW111	Black Bronzed	1 pc	10-12 weeks	22.90 kg	19.100	23.875
18004254 18004260	Verde Comodoro Fenix Nano Laminate (0750) & Grey Rehau (97959), Glossy Edge	140 x 50 x 95 cm	HW111	Black Bronzed	1 pc	10-12 weeks	22.90 kg	19.100	23.875
18004255 18004261	Azzurro Naxos Fenix Nano Laminate (0771) & Light Blue Rehau (77193), Glossy Edge	140 x 50 x 95 cm	HW111	Black Bronzed	1 pc	10-12 weeks	22.90 kg	19.100	23.875
18004221	Linoleum - all colours	140 x 50 x 95 cm	HW111	Black Bronzed	1 pc	10-12 weeks	22.90 kg	17.904	22.380
18004231	Nano Laminate - all colours	140 x 50 x 95 cm	HW111	Black Bronzed	1 pc	10-12 weeks	22.90 kg	19.100	23.875
18004241	Veneer - oak or walnut	140 x 50 x 95 cm	HW111	Black Bronzed	1 pc	10-12 weeks	22.90 kg	19.100	23.875
30310020	Cut out for cable management					10 -12 weeks		592	740
30310021	Cable pit set / Black					10 -12 weeks		3.100	3.875
30310022	Cable pit set / Silver					10 -12 weeks		3.100	3.875



EU Ecolabel certified, validating high standards of durability, circular design, and responsible use of chemicals. Please contact our sales team for a list of EU Ecolabel compliant combinations.

Material: Steel and aluminium base, MDF tabletop with Fenix Nano laminate, Forbo linoleum or wood veneer.

Nero Ingo is produced with a matching high gloss edgeband.

All other colours are produced with a matching ABS edgeband. Wood veneer is produced with a matching edgeband.

All table tops and edgebands can be mixed and matched
Plastic gliders installed as standard.
Castors are available upon request.

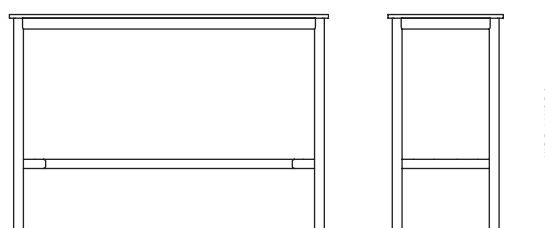

Drip^{HW112} Hee Welling 2021



Item code	Table top	Size	Model	Base	Colli qty.	Lead time	Weight	PRICE EX. VAT (SEK)	PRICE INC. VAT (SEK)
18004301 18004306	Nero Ingo Fenix Nano Laminate (0720)	140 x 80 x 95 cm	HW112	Black Bronzed	1 pc	Stock item	30.20 kg	17.308	21.635
18004350 18004356	Smokey Blue Forbo Linoleum (4179) & Dark Blue Ostermann (043.5984), Glossy Edge	140 x 80 x 95 cm	HW112	Black Bronzed	1 pc	10-12 weeks	30.20 kg	17.904	22.380
18004351 18004357	Pearl Forbo Linoleum (4157) & Soft Yellow Rehau (78162), Glossy Edge	140 x 80 x 95 cm	HW112	Black Bronzed	1 pc	10-12 weeks	30.20 kg	17.904	22.380
18004311 18004312	Burgundy Forbo Linoleum (4154) & Red Ostermann (043.4110), Glossy Edge	140 x 80 x 95 cm	HW112	Black Bronzed	1 pc	10-12 weeks	30.20 kg	17.904	22.380
18004352 18004358	Castoro Ottawa Fenix Nano Laminate (0720) & Light Brown Rehau (V1272), Glossy Edge	140 x 80 x 95 cm	HW112	Black Bronzed	1 pc	10-12 weeks	30.20 kg	19.100	23.875
18004353 18004359	Cacao Orinoco Fenix Nano Laminate (0749) & Grey Brown Rehau (71038), Glossy Edge	140 x 80 x 95 cm	HW112	Black Bronzed	1 pc	10-12 weeks	30.20 kg	19.100	23.875
18004354 18004360	Verde Comodoro Fenix Nano Laminate (0750) & Grey Rehau (97959), Glossy Edge	140 x 80 x 95 cm	HW112	Black Bronzed	1 pc	10-12 weeks	30.20 kg	19.100	23.875
18004355 18004361	Azzurro Naxos Fenix Nano Laminate (0771) & Light Blue Rehau (77193), Glossy Edge	140 x 80 x 95 cm	HW112	Black Bronzed	1 pc	10-12 weeks	30.20 kg	19.100	23.875
18004321	Linoleum - all colours	140 x 80 x 95 cm	HW112	Black Bronzed	1 pc	10-12 weeks	30.20 kg	17.904	22.380
18004331	Nano Laminate - all colours	140 x 80 x 95 cm	HW112	Black Bronzed	1 pc	10-12 weeks	30.20 kg	19.100	23.875
18004341	Veneer - oak or walnut	140 x 80 x 95 cm	HW112	Black Bronzed	1 pc	10-12 weeks	30.20 kg	19.100	23.875
30310020	Cut out for cable management					10 -12 weeks		592	740
30310021	Cable pit set / Black					10 -12 weeks		3.100	3.875
30310022	Cable pit set / Silver					10 -12 weeks		3.100	3.875



EU Ecolabel certified, validating high standards of durability, circular design, and responsible use of chemicals. Please contact our sales team for a list of EU Ecolabel compliant combinations.

Material: Steel and aluminium base, MDF tabletop with Fenix Nano laminate, Forbo linoleum or wood veneer.

Nero Ingo is produced with a matching high gloss edgeband.

All other colours are produced with a matching ABS edgeband. Wood veneer is produced with a matching edgeband.

All table tops and edgebands can be mixed and matched
Plastic gliders installed as standard.
Castors are available upon request.

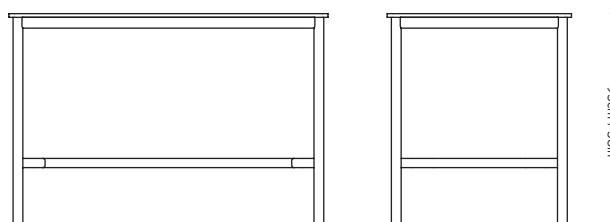

Drip ^{HW113} Hee Welling 2021



Item code	Table top	Size	Model	Base	Colli qty.	Lead time	Weight	PRICE EX. VAT (SEK)	PRICE INC. VAT (SEK)
18004401 18004406	Nero Ingo Fenix Nano Laminate (0720)	140 x 50 x 105 cm	HW113	Black Bronzed	1 pc	Stock item	23.40 kg	16.712 16.712	20.890 20.890
18004450 18004456	Smokey Blue Forbo Linoleum (4179) & Dark Blue Ostermann (043.5984), Glossy Edge	140 x 50 x 105 cm	HW113	Black Bronzed	1 pc	10-12 weeks	23.40 kg	17.904 17.904	22.380 22.380
18004451 18004457	Pearl Forbo Linoleum (4157) & Soft Yellow Rehau (78162), Glossy Edge	140 x 50 x 105 cm	HW113	Black Bronzed	1 pc	10-12 weeks	23.40 kg	17.904 17.904	22.380 22.380
18004411 18004412	Burgundy Forbo Linoleum (4154) & Red Ostermann (043.4110), Glossy Edge	140 x 50 x 105 cm	HW113	Black Bronzed	1 pc	10-12 weeks	23.40 kg	17.904 17.904	22.380 22.380
18004452 18004458	Castoro Ottawa Fenix Nano Laminate (0720) & Light Brown Rehau (V1272), Glossy Edge	140 x 50 x 105 cm	HW113	Black Bronzed	1 pc	10-12 weeks	23.40 kg	19.100 19.100	23.875 23.875
18004453 18004459	Cacao Orinoco Fenix Nano Laminate (0749) & Grey Brown Rehau (71038), Glossy Edge	140 x 50 x 105 cm	HW113	Black Bronzed	1 pc	10-12 weeks	23.40 kg	19.100 19.100	23.875 23.875
18004454 18004460	Verde Comodoro Fenix Nano Laminate (0750) & Grey Rehau (97959), Glossy Edge	140 x 50 x 105 cm	HW113	Black Bronzed	1 pc	10-12 weeks	23.40 kg	19.100 19.100	23.875 23.875
18004455 18004461	Azzurro Naxos Fenix Nano Laminate (0771) & Light Blue Rehau (77193), Glossy Edge	140 x 50 x 105 cm	HW113	Black Bronzed	1 pc	10-12 weeks	23.40 kg	19.100 19.100	23.875 23.875
18004421	Linoleum - all colours	140 x 50 x 105 cm	HW113	Black Bronzed	1 pc	10-12 weeks	23.40 kg	17.904 17.904	22.380 22.380
18004441	Nano Laminate - all colours	140 x 50 x 105 cm	HW113	Black Bronzed	1 pc	10-12 weeks	23.40 kg	19.100 19.100	23.875 23.875
18004451	Veneer - oak or walnut	140 x 50 x 105 cm	HW113	Black, Bronzed	1 pc	10-12 weeks	23.40 kg	19.100 19.100	23.875 23.875
30310020	Cut out for cable management					10 -12 weeks		592	740
30310021	Cable pit set / Black					10 -12 weeks		3.100	3.875
30310022	Cable pit set / Silver					10 -12 weeks		3.100	3.875



EU Ecolabel certified, validating high standards of durability, circular design, and responsible use of chemicals. Please contact our sales team for a list of EU Ecolabel compliant combinations.

Material: Steel and aluminium base, MDF tabletop with Fenix Nano laminate, Forbo linoleum or wood veneer.

Nero Ingo is produced with a matching high gloss edgeband.

All other colours are produced with a matching ABS edgeband. Wood veneer is produced with a matching edgeband.

All table tops and edgebands can be mixed and matched
Plastic gliders installed as standard.
Castors are available upon request.

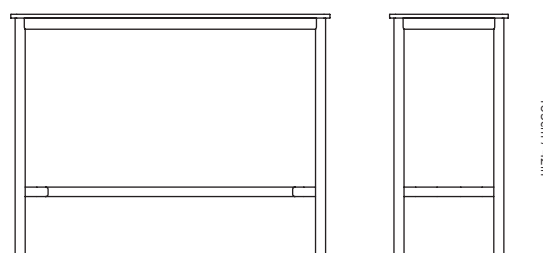

Drip^{HW114} Hee Welling 2021



Item code	Table top	Size	Model	Base	Colli qty.	Lead time	Weight	PRICE EX. VAT (SEK)	PRICE INC. VAT (SEK)
18004501 18004506	Nero Ingo Fenix Nano Laminate (0720)	140 x 80 x 105 cm	HW114	Black Bronzed	1 pc	Stock item	30.30 kg	17.308	21.635
18004550 18004556	Smokey Blue Forbo Linoleum (4179) & Dark Blue Ostermann (043.5984), Glossy Edge	140 x 80 x 105 cm	HW114	Black Bronzed	1 pc	10-12 weeks	30.30 kg	17.904	22.380
18004551 18004557	Pearl Forbo Linoleum (4157) & Soft Yellow Rehau (78162), Glossy Edge	140 x 80 x 105 cm	HW114	Black Bronzed	1 pc	10-12 weeks	30.30 kg	17.904	22.380
18004511 18004512	Burgundy Forbo Linoleum (4154) & Red Ostermann (043.4110), Glossy Edge	140 x 80 x 105 cm	HW114	Black Bronzed	1 pc	10-12 weeks	30.30 kg	17.904	22.380
18004552 18004558	Castoro Ottawa Fenix Nano Laminate (0720) & Light Brown Rehau (V1272), Glossy Edge	140 x 80 x 105 cm	HW114	Black Bronzed	1 pc	10-12 weeks	30.30 kg	19.100	23.875
18004553 18004559	Cacao Orinoco Fenix Nano Laminate (0749) & Grey Brown Rehau (71038), Glossy Edge	140 x 80 x 105 cm	HW114	Black Bronzed	1 pc	10-12 weeks	30.30 kg	19.100	23.875
18004554 18004560	Verde Comodoro Fenix Nano Laminate (0750) & Grey Rehau (97959), Glossy Edge	140 x 80 x 105 cm	HW114	Black Bronzed	1 pc	10-12 weeks	30.30 kg	19.100	23.875
18004555 18004561	Azzurro Naxos Fenix Nano Laminate (0771) & Light Blue Rehau (77193), Glossy Edge	140 x 80 x 105 cm	HW114	Black Bronzed	1 pc	10-12 weeks	30.30 kg	19.100	23.875
18004521	Linoleum - all colours	140 x 80 x 105 cm	HW114	Black Bronzed	1 pc	10-12 weeks	30.30 kg	17.904	22.380
18004531	Nano Laminate - all colours	140 x 80 x 105 cm	HW114	Black Bronzed	1 pc	10-12 weeks	30.30 kg	19.100	23.875
18004541	Veneer - oak or walnut	140 x 80 x 105 cm	HW114	Black Bronzed	1 pc	10-12 weeks	30.30 kg	19.100	23.875
30310020	Cut out for cable management					10 -12 weeks		592	740
30310021	Cable pit set / Black					10 -12 weeks		3.100	3.875
30310022	Cable pit set / Silver					10 -12 weeks		3.100	3.875



EU Ecolabel certified, validating high standards of durability, circular design, and responsible use of chemicals. Please contact our sales team for a list of EU Ecolabel compliant combinations.

Material: Steel and aluminium base, MDF tabletop with Fenix Nano laminate, Forbo linoleum or wood veneer.

Nero Ingo is produced with a matching high gloss edgeband.

All other colours are produced with a matching ABS edgeband. Wood veneer is produced with a matching edgeband.

All table tops and edgebands can be mixed and matched
Plastic gliders installed as standard.
Castors are available upon request.

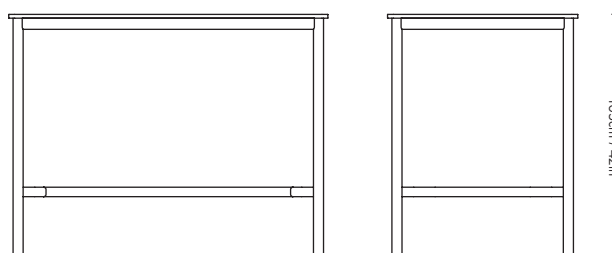

Drip Made to order Hee Welling 2021

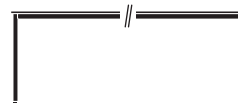

Item code	Table top	Base	Size	Lead time	PRICE EX. VAT (SEK)	PRICE INC. VAT (SEK)
18002221	Forbo Linoleum	Black, Bronzed	L: 141-170 x W: 80 x H: 74cm	10-12 weeks	15.516	19.395
18002321			L: 171-200 x W: 80 x H: 74cm		17.308	21.635
18002421			L: 201-250 x W: 100 x H: 74cm		19.100	23.875
18002521			L: 251-300 x W: 100 x H: 74cm		22.680	28.350
18002601			L: 201-250 x W: 110 x H: 74cm		20.292	25.365
18002611			L: 251-300 x W: 110 x H: 74cm		23.276	29.095
18003421			L: 201-250 x W: 120 x H: 74cm		21.488	26.860
18003521	L: 251-300 x W: 120 x H: 74cm	24.472	30.590			
18002231	Fenix NTM Nano Laminate	Black, Bronzed	L: 141-170 x W: 80 x H: 74cm	10-12 weeks	16.112	20.140
18002331			L: 171-200 x W: 80 x H: 74cm		17.904	22.380
18002431			L: 201-250 x W: 100 x H: 74cm		20.292	25.365
18002531			L: 251-300 x W: 100 x H: 74cm		23.276	29.095
18002602			L: 201-250 x W: 110 x H: 74cm		20.888	26.110
18002612			L: 251-300 x W: 110 x H: 74cm		23.876	29.845
18003431			L: 201-250 x W: 120 x H: 74cm		22.084	27.605
18003531	L: 251-300 x W: 120 x H: 74cm	25.068	31.335			
18002241	Oak or Walnut Veneer	Black, Bronzed	L: 141-170 x W: 80 x H: 74cm	10-12 weeks	16.712	20.890
18002341			L: 171-200 x W: 80 x H: 74cm		18.500	23.125
18002441			L: 201-250 x W: 100 x H: 74cm		21.488	26.860
18002541			L: 251-300 x W: 100 x H: 74cm		23.876	29.845
18002603			L: 201-250 x W: 110 x H: 74cm		21.488	26.860
18002613			L: 251-300 x W: 110 x H: 74cm		24.472	30.590
18003441			L: 201-250 x W: 120 x H: 74cm		22.680	28.350
18003541	L: 251-300 x W: 120 x H: 74cm	25.664	32.080			
30310020	Cut out for cable management			10-12 weeks	592	740
30310021	Cable access set / Black			10-12 weeks	3.100	3.875
30310022	Cable access set / Silver			10-12 weeks	3.100	3.875

* Please note that the cable access set is not pre-installed upon delivery



EU Ecolabel certified, validating high standards of durability, circular design, and responsible use of chemicals. Please contact our sales team for a list of EU Ecolabel compliant combinations.

Material: Steel and aluminium base, MDF tabletop with Fenix Nano laminate, Forbo linoleum or wood veneer.

Base: Black or Bronzed.

All other colours are produced with a matching ABS edgeband. Wood veneer is produced with a matching edgeband.

Plastic gliders are installed as standard.

Castors are available upon request.

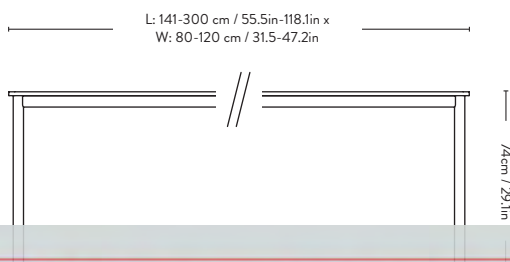

22% RABATT SKA DRAS AV PÅ ANGIVNA PRISER

Drip Made to order Hee Welling 2021

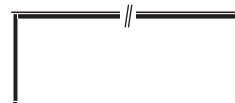

Item code	Table top	Base	Size	Lead time	PRICE EX. VAT (SEK)	PRICE INC. VAT (SEK)			
18002621	Forbo Linoleum	Black, Bronzed	L: 301-350 x W: 110 x H: 74cm	10-12 weeks	28.652	35.815			
18002721			L: 351-400 x W: 110 x H: 74cm		31.040	38.800			
18002821			L: 401-450 x W: 110 x H: 74cm		31.636	39.545			
18002921			L: 451-500 x W: 110 x H: 74cm		34.620	43.275			
18002950			L: 501-550 x W: 110 x H: 74cm		35.816	44.770			
18002965			L: 551-600 x W: 110 x H: 74cm		38.204	47.755			
18003621			L: 301-350 x W: 120 x H: 74cm		29.844	37.305			
18003721			L: 351-400 x W: 120 x H: 74cm		32.232	40.290			
18003821			L: 401-450 x W: 120 x H: 74cm		32.828	41.035			
18003921			L: 451-500 x W: 120 x H: 74cm		35.816	44.770			
18004021			L: 501-550 x W: 120 x H: 74cm		37.008	46.260			
18004121			L: 551-600 x W: 120 x H: 74cm		39.396	49.245			
18002631			Fenix NTM Nano Laminate		Black, Bronzed	L: 301-350 x W: 110 x H: 74cm	10-12 weeks	29.844	37.305
18002731						L: 351-400 x W: 110 x H: 74cm		32.232	40.290
18002831	L: 401-450 x W: 110 x H: 74cm	32.828		41.035					
18002931	L: 451-500 x W: 110 x H: 74cm	35.816		44.770					
18002955	L: 501-550 x W: 110 x H: 74cm	37.008		46.260					
18002970	L: 551-600 x W: 110 x H: 74cm	39.396		49.245					
18003631	L: 301-350 x W: 120 x H: 74cm	31.040		38.800					
18003731	L: 351-400 x W: 120 x H: 74cm	33.428		41.785					
18003831	L: 401-450 x W: 120 x H: 74cm	34.024		42.530					
18003931	L: 451-500 x W: 120 x H: 74cm	37.008		46.260					
18004031	L: 501-550 x W: 120 x H: 74cm	38.204		47.755					
18004131	L: 551-600 x W: 120 x H: 74cm	40.592		50.740					
18002641	Oak or Walnut Veneer	Black, Bronzed		L: 301-350 x W: 110 x H: 74cm		10-12 weeks		31.040	38.800
18002741				L: 351-400 x W: 110 x H: 74cm				33.428	41.785
18002841			L: 401-450 x W: 110 x H: 74cm	33.428	41.785				
18002941			L: 451-500 x W: 110 x H: 74cm	37.008	46.260				
18002960			L: 501-550 x W: 110 x H: 74cm	38.204	47.755				
18002975			L: 551-600 x W: 110 x H: 74cm	40.592	50.740				
18003641			L: 301-350 x W: 120 x H: 74cm	32.232	40.290				
18003741			L: 351-400 x W: 120 x H: 74cm	34.620	43.275				
18003841			L: 401-450 x W: 120 x H: 74cm	34.620	43.275				
18003941			L: 451-500 x W: 120 x H: 74cm	38.204	47.755				
18004041			L: 501-550 x W: 120 x H: 74cm	39.396	49.245				
18004141			L: 551-600 x W: 120 x H: 74cm	41.784	52.230				
18009999			Linking device				Stock item		
30310020			Cut out for cable management				10-12 weeks	592	740
30310021	Cable access set / Black			10-12 weeks	3.100	3.875			
30310022	Cable access set / Silver			10-12 weeks	3.100	3.875			



EU Ecolabel certified, validating high standards of durability, circular design, and responsible use of chemicals. Please contact our sales team for a list of EU Ecolabel compliant combinations.

Material: Steel and aluminium base, MDF tabletop with Fenix Nano laminate, Forbo linoleum or wood veneer.

Base: Black or Bronzed.

All other colours are produced with a matching ABS edgeband. Wood veneer is produced with a matching edgeband. Tables larger than 3 meters are produced with 6 legs

Plastic gliders are installed as standard. Castors are available upon request.

* Please note that the cable access set is not pre-installed upon delivery

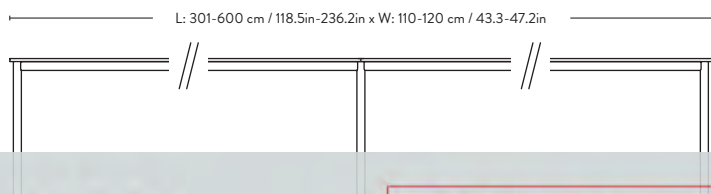

Pavilion AV16 & AV17 Anderssen & Voll 2021

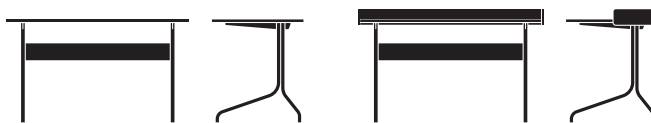

Item no.	Product	Model	Colli qty.	Lead time	Weight	PRICE EX. VAT (SEK)	PRICE INC. VAT (SEK)
50170000	Black Linoleum (4023) w. black oak & black base	AV16	1 pc	Stock item	23.30 kg	10.740	13.425
50170001	Mushroom Linoleum (4176) w. oak & chrome base	AV16	1 pc	Stock item	23.30 kg	10.740	13.425
50170002	Iron Linoleum (4178) w. walnut & chrome base	AV16	1 pc	Stock item	23.30 kg	10.740	13.425
50170003	Mushroom Linoleum (4176) w. oak & chrome base	AV17	1 pc	Stock item	24.20 kg	13.128	16.410
50170004	Iron Linoleum (4178) w. walnut & chrome base	AV17	1 pc	Stock item	24.20 kg	13.128	16.410

Material: Steel, Water based lacquered veneer, Forbo linoleum.

Plastic gliders are installed as standard.

Cut out and cable management available upon request with a minimum order quantity of same variant of 10 pcs.

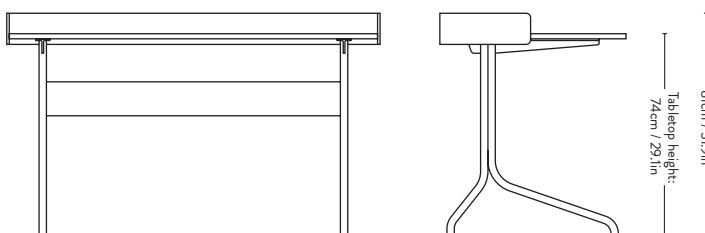
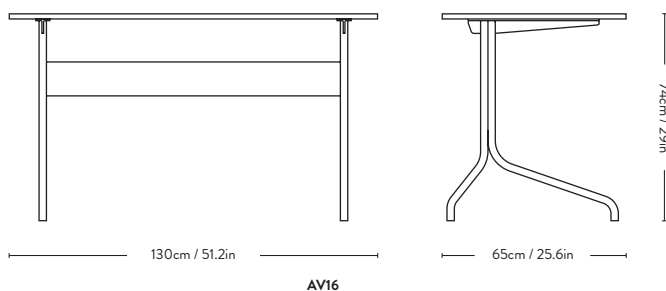

Pavilion AV18, AV19 & AV24 Anderssen & Voll 2022



Item no.	Top	Size	Base	Model	Colli qty.	Lead time	Weight	PRICE EX. VAT (SEK)	PRICE INC. VAT (SEK)
50180000	Oak	90x160cm	Black	AV18	1 pc	Stock item	44.0 kg	13.724	17.155
50180001			Chrome					13.724	17.155
50180002	Black Oak	90x160cm	Black	AV18	1 pc	Stock item	44.0 kg	13.724	17.155
50180003			Chrome					13.724	17.155
50180004	Walnut	90x160cm	Black	AV18	1 pc	Stock item	44.0 kg	14.324	17.905
50180005			Chrome					14.324	17.905

Item no.	Top	Size	Base	Model	Colli qty.	Lead time	Weight	PRICE EX. VAT (SEK)	PRICE INC. VAT (SEK)
50190000	Oak	90x200cm	Black	AV19	1 pc	Stock item	53.5 kg	14.920	18.650
50190001			Chrome					14.920	18.650
50190002	Black Oak	90x200cm	Black	AV19	1 pc	Stock item	53.5 kg	14.920	18.650
50190003			Chrome					14.920	18.650
50190004	Walnut	90x200cm	Black	AV19	1 pc	Stock item	53.5 kg	15.516	19.395
50190005			Chrome					15.516	19.395

Item no.	Top	Size	Base	Model	Colli qty.	Lead time	Weight	PRICE EX. VAT (SEK)	PRICE INC. VAT (SEK)
50260000	Oak	110x250cm	Black	AV24	1 pc	Stock item	62.0 kg	21.488	26.860
50260001			Chrome					21.488	26.860
50260002	Black Oak	110x250cm	Black	AV24	1 pc	Stock item	62.0 kg	21.488	26.860
50260003			Chrome					21.488	26.860
50260004	Walnut	110x250cm	Black	AV24	1 pc	Stock item	62.0 kg	22.680	28.350
50260005			Chrome					22.680	28.350

Material: Steel, Water based lacquered veneer, MDF
Plastic gliders are installed as standard.

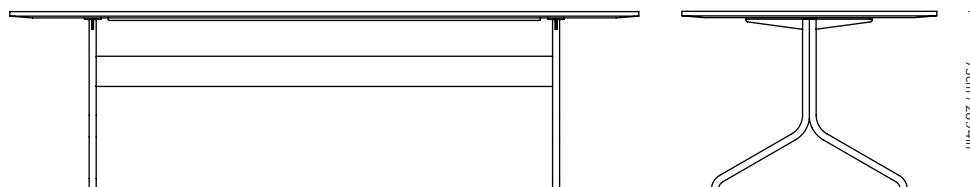
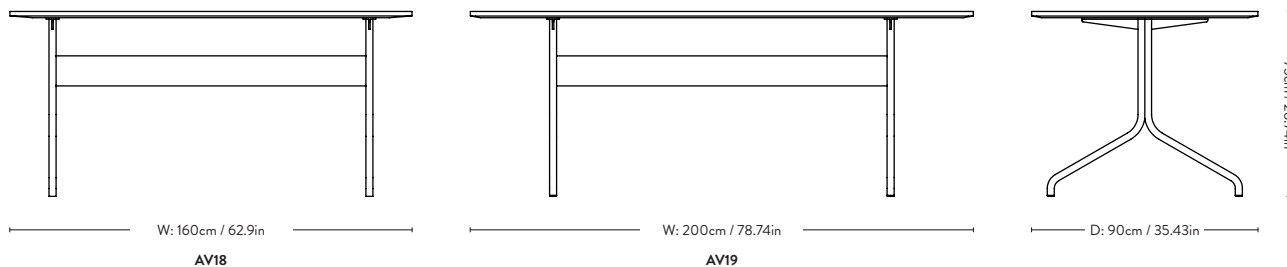

Lato LN8 & LN9 Luca Nichetto 2018

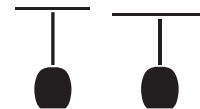

Item no.	Product	Size	Model	Colli qty.	Lead time	Weight	PRICE EX. VAT (SEK)	PRICE INC. VAT (SEK)
86202001	Warm Black w. Emparador Marble	Ø40cm	LN8	1 pc	Stock item	19.50 kg	4.532	5.665
86202005	Ivory white w. Crema Diva Marble	Ø40cm	LN8	1 pc	Stock item	19.50 kg	4.532	5.665
86202030	Deep Green w. Verde Alpi	Ø40cm	LN8	1 pc	Stock item	19.50 kg	4.532	5.665
86202096	Walnut w. Emparador marble	Ø40cm	LN8	1 pc	Stock item	19.00 kg	5.008	6.260
86202092	Oak w. Crema Diva marble	Ø40cm	LN8	1 pc	Stock item	19.00 kg	5.248	6.560
86202010	Warm Black w. Emparador Marble	40x50cm	LN9	1 pc	Stock item	20.10 kg	4.532	5.665
86202015	Ivory white w. Crema Diva Marble	40x50cm	LN9	1 pc	Stock item	20.10 kg	4.532	5.665
86202035	Deep Green w. Verde Alpi	40x50cm	LN9	1 pc	Stock item	20.10 kg	4.532	5.665
86202196	Walnut w. Emparador marble	40x50cm	LN9	1 pc	Stock item	19.00 kg	5.008	6.260
86202192	Oak w. Crema Diva marble	40x50cm	LN9	1 pc	Stock item	19.00 kg	5.248	6.560

Material: Marble and powder coated steel or water based lacquered veneer.

Felt gliders installed as standard.

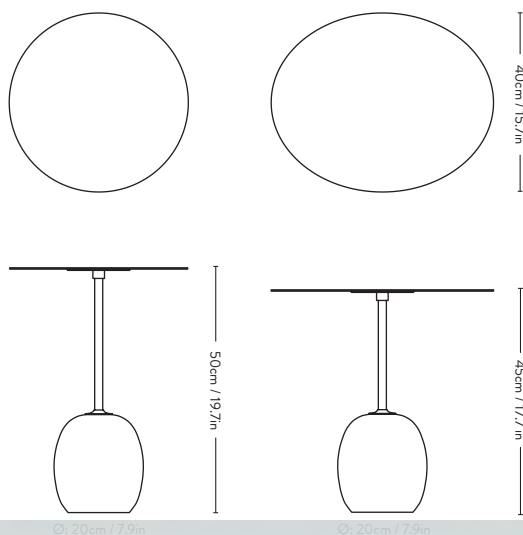

Rotate^{SC73} Space Copenhagen 2022



Item no.	Colour	Model	Colli qty.	Lead time	Weight	PRICE EX. VAT (SEK)	PRICE INC. VAT (SEK)
42000001	Terracotta	SC73	1 pc	Stock item	14.75 kg	3.576	4.470
42000004	Hunter	SC73	1 pc	Stock item	14.75 kg	3.576	4.470
42000005	Ivory	SC73	1 pc	Stock item	14.75 kg	3.576	4.470
42000006	Merlot	SC73	1 pc	Stock item	14.75 kg	3.576	4.470

Material: Powder coated steel, castors.

Thickness:
0.2cm / 0.08in

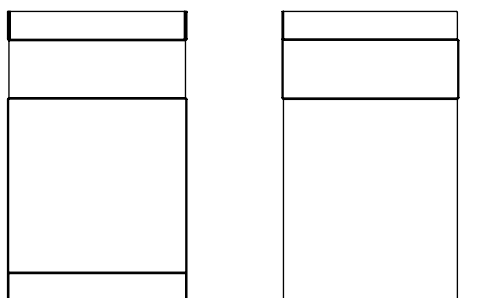

Alima ^{NDS1} Note Design Studio 2022

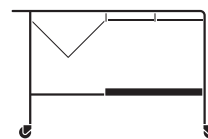

Item no.	Product	Tray	Model	Colli qty.	Lead time	Weight	PRICE EX. VAT (SEK)	PRICE INC. VAT (SEK)
23500001	Chrome	Oak	NDS1	1 pc	Stock item	10.0 kg	7.756	9.695
23500002	Chrome	Walnut	NDS1	1 pc	Stock item	10.0 kg	7.756	9.695
23500003	Matt Black	Oak	NDS1	1 pc	Stock item	10.0 kg	7.756	9.695
23500004	Matt Black	Walnut	NDS1	1 pc	Stock item	10.0 kg	7.756	9.695

Material: Steel / Powder coated steel trolley.
Walnut / Oak trays. Leather handle. Castors.

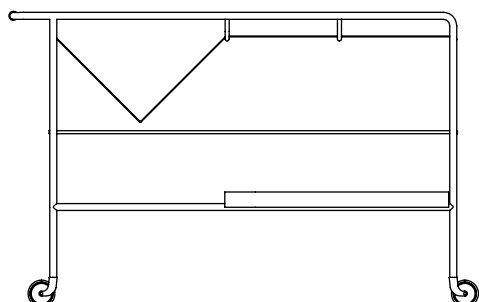

59,4cm / 23,4in

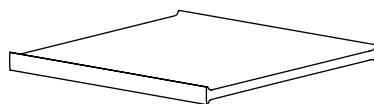

3cm / 1,2in

W: 89,9cm / 35,4in
D: 41,9cm / 16,5in
NDS1

W: 45cm / 17,7in
D: 43,1cm / 16,9in

NEW

Halten ^{SH9} Sebastian Herkner 2024



Item no.	Colour	Model	Colli qty.	Lead time	Weight	PRICE EX. VAT (SEK)	PRICE INC. VAT (SEK)
89101201	Smoked Glass w. Warm black	SH9	1 pc	Stock item	6.74 kg	4.172	5.215
89101202	Verde Guatemala w. Warm black	SH9	1 pc	Stock item	6.96 kg	3.816	4.770
89101203	Smoked Glass w. Polished stainless steel	SH9	1 pc	Stock item	6.74 kg	4.412	5.515
89101204	Verde Guatemala w. Polished stainless steel	SH9	1 pc	Stock item	6.96 kg	4.056	5.070

Materials: Steel, marble and cast glass

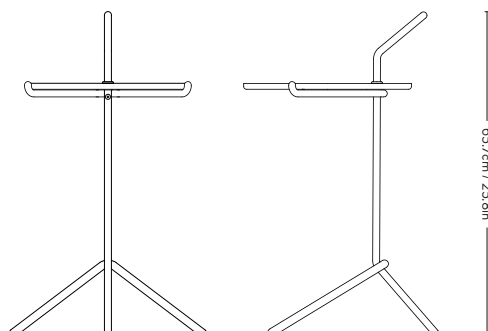

Capture | Coat stand ^{SC77} Space Copenhagen 2022



Item no.	Product	Model	Colour	Colli qty.	Lead time	Weight	PRICE EX. VAT (SEK)	PRICE INC. VAT (SEK)
25050113	Capture Coat stand	SC77	Graphite / Colour knob	1 pc	Stock item	6.00 kg	5.964	7.455
25050112	Capture Coat stand	SC77	Graphite / Oak knob	1 pc	Stock item	6.00 kg	5.964	7.455

Materials: Powder coated aluminium and water based lacquered oak.

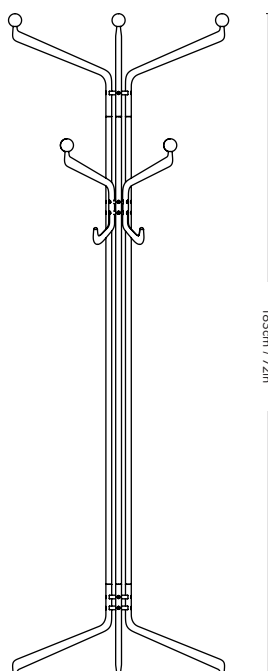

Amore SC49, SC50, SC56 Space Copenhagen 2018

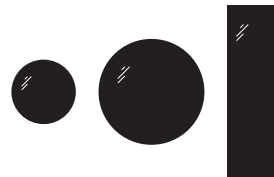

Item no.	Colour	Size	Model	Colli qty.	Lead time	Weight	PRICE EX. VAT (SEK)	PRICE INC. VAT (SEK)
86101540	Bronzed Brass	Ø70cm	SC56	1 pc	Stock item	29.60 kg	8.948	11.185
86101640	Bronzed Brass	Ø115cm	SC49	1 pc	Stock item	25.80 kg	12.532	15.665
86101040	Bronzed Brass	60x190cm	SC50	1 pc	Stock item	29.60 kg	14.920	18.650

Material: Bronzed brass frame, silver coloured mirror, textile backing.

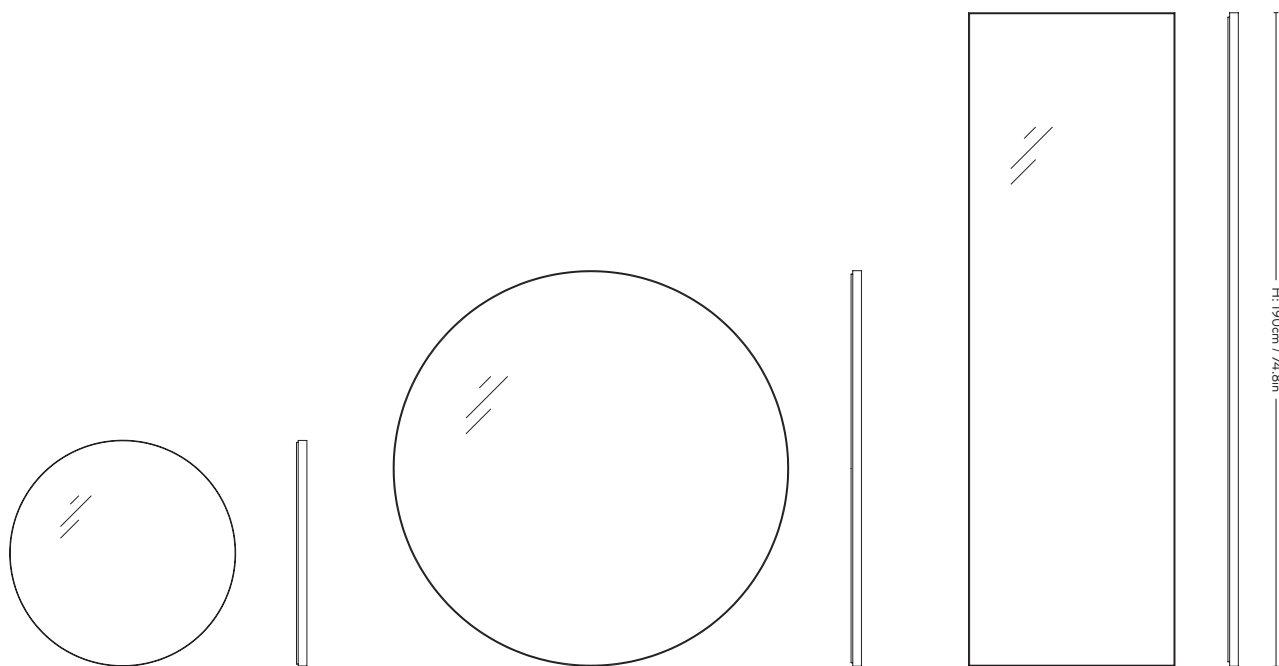

Sillon SH4-SH7

Sebastian Herkner

2019

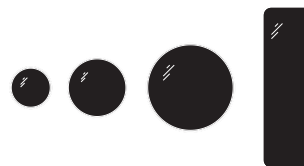

Item no.	Colour	Size	Model	Colli qty.	Lead time	Weight	PRICE EX. VAT (SEK)	PRICE INC. VAT (SEK)
23101296	Brass	Ø46cm	SH4	1 pc	Stock item	4.50 kg	2.980	3.725
23101201	Stainless Steel	Ø46cm	SH4	1 pc	Stock item	4.50 kg	2.620	3.275
23101396	Brass	Ø66cm	SH5	1 pc	Stock item	8.00 kg	5.008	6.260
23101301	Stainless Steel	Ø66cm	SH5	1 pc	Stock item	8.00 kg	4.532	5.665
23101496	Brass	Ø96cm	SH6	1 pc	Stock item	14.50 kg	7.160	8.950
23101401	Stainless Steel	Ø96cm	SH6	1 pc	Stock item	14.50 kg	6.560	8.200
23101596	Brass	190x60cm	SH7	1 pc	Stock item	28.50 kg	14.324	17.905
23101501	Stainless Steel	190x60cm	SH7	1 pc	Stock item	28.50 kg	13.368	16.710

Material: Plated steel & silver coloured mirror

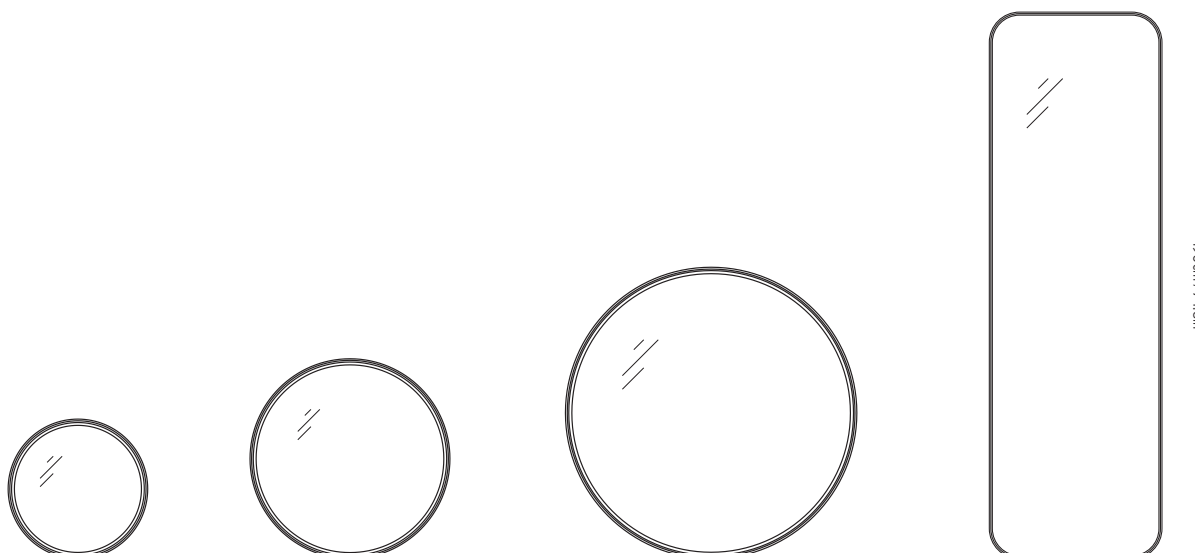

46cm / 18.1in

66cm / 26in

96cm / 37.8in

60cm / 23.6in

190cm / 74.8in

Table Settings

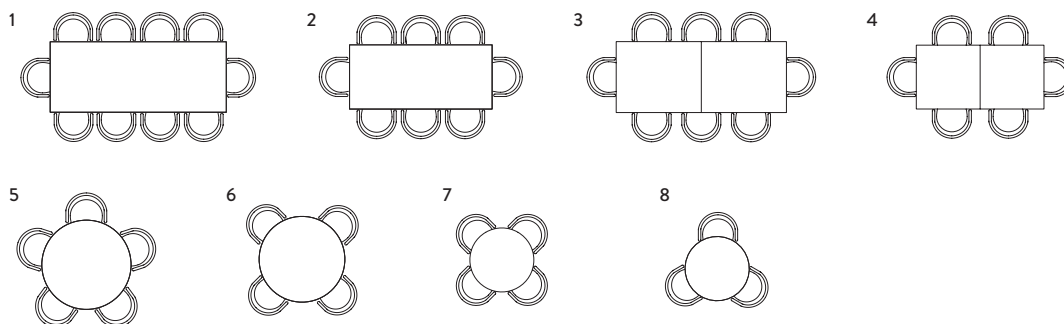

In Between Chair

Product	Size	Chairs
(1) In Between Table SK6	250 x 100cm / 98.4 x 39.3in	10 x In Between chairs (SK1/SK2)
(2) In Between Table SK5	200 x 90cm / 78.7 x 35.4in	8 x In Between chairs (SK1/SK2)
(3) Patch Table HW2	240 (+100cm) x 100cm / 94.5 (+39.4in) x 39.4in	8 x In Between chairs (SK1/SK2) - (extendend +2)
(4) Patch Table HW1	180 (+100cm) x 90cm / 70.9 (+39.4in) x 35.4in	6 x In Between chairs (SK1/SK2) - (extendend +2)
(5) In Between Table SK12	Ø: 120cm / 47.2in	5 x In Between chairs (SK1/SK2)
(6) In Between Table SK4	Ø: 120cm / 47.2in	4 x In Between chairs (SK1/SK2)
(7) In Between Table SK11	Ø: 90cm / 35.4in	4 x In Between chairs (SK1/SK2)
(8) In Between Table SK3	Ø: 90cm / 35.4in	3 x In Between chairs (SK1/SK2)

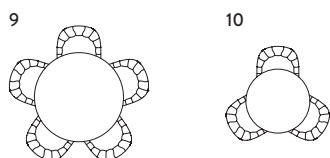

Loafer Dining Chair

Product	Size	Chairs
(9) In Between Table SK12	Ø: 120cm / 35.4in	5 x Loafer dining (SC24)
(10) In Between Table SK11	Ø: 90cm / 35.4in	3 x Loafer dining (SC24)

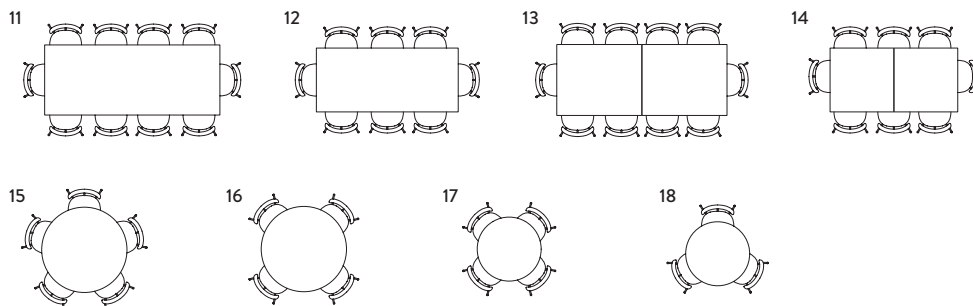

Pavilion Dining Chair

Product	Size	Chairs
(11) In Between Table SK6	250 x 100cm / 98.4 x 39.3in	10 x Pavilion (AV1/AV3)
(12) In Between Table SK5	200 x 90cm / 78.7 x 35.4in	8 x Pavilion (AV1/AV3)
(13) Patch Table HW2	240 (+100cm) x 100cm / 94.5 (+39.4in) x 39.4in	10 x Pavilion (AV1/AV3) - (extendend +4)
(14) Patch Table HW1	180 (+100cm) x 90cm / 70.9 (+39.4in) x 35.4in	8 x Pavilion (AV1/AV3) - (extendend +4)
(15) In Between Table SK12	Ø: 120cm / 47.2in	5 x Pavilion (AV1/AV3)
(16) In Between Table SK4	Ø: 120cm / 47.2in	4 x Pavilion (AV1/AV3)
(17) In Between Table SK11	Ø: 90cm / 35.4in	4 x Pavilion (AV1/AV3)
(18) In Between Table SK3	Ø: 90cm / 35.4in	3 x Pavilion (AV1/AV3)

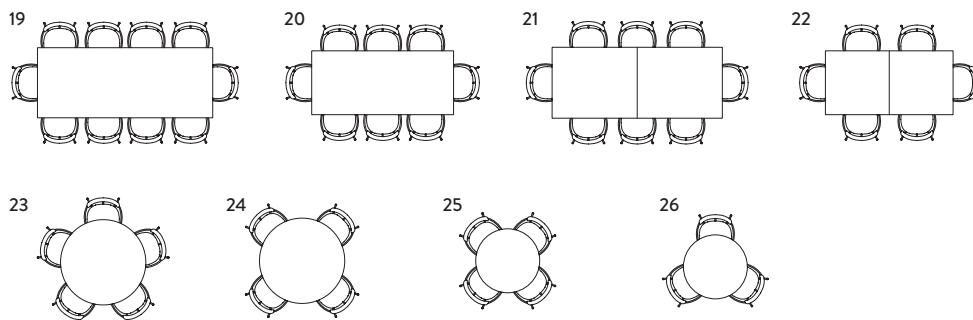

Pavilion Armrest Chair

Product	Size	Chairs
(19) In Between Table SK6	250 x 100cm / 98.4 x 39.3in	10 x Pavilion (AV2/AV4)
(20) In Between Table SK5	200 x 90cm / 78.7 x 35.4in	8 x Pavilion (AV2/AV4)
(21) Patch Table HW2	240 (+100cm) x 100cm / 94.5 (+39.4in) x 39.4in	8 x Pavilion (AV2/AV4) - (extended +2)
(22) Patch Table HW1	180 (+100cm) x 90cm / 70.9 (+39.4in) x 35.4in	6 x Pavilion (AV2/AV4) - (extended +2)
(23) In Between Table SK12	Ø: 120cm / 47.2in	5 x Pavilion (AV2/AV4)
(24) In Between Table SK4	Ø: 120cm / 47.2in	4 x Pavilion (AV2/AV4)
(25) In Between Table SK11	Ø: 90cm / 35.4in	4 x Pavilion (AV2/AV4)
(26) In Between Table SK3	Ø: 90cm / 35.4in	3 x Pavilion (AV2/AV4)

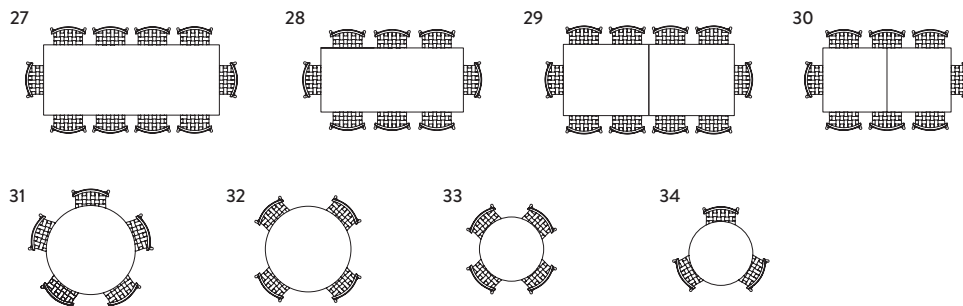

Betty Dining Chair

Product	Size	Chairs
(27) In Between Table SK6	250 x 100cm / 98.4 x 39.3in	10 x Betty (TK1/TK2)
(28) In Between Table SK5	200 x 90cm / 78.7 x 35.4in	8 x Betty (TK1/TK2)
(29) Patch Table HW2	240 (+100cm) x 100cm / 94.5 (+39.4in) x 39.4in	10 x Betty (TK1/TK2) - (extended +4)
(30) Patch Table HW1	180 (+100cm) x 90cm / 70.9 (+39.4in) x 35.4in	8 x Betty (TK1/TK2) - (extended +4)
(31) In Between Table SK12	Ø: 120cm / 47.2in	5 x Betty (TK1/TK2)
(32) In Between Table SK4	Ø: 120cm / 47.2in	4 x Betty (TK1/TK2)
(33) In Between Table SK11	Ø: 90cm / 35.4in	4 x Betty (TK1/TK2)
(34) In Between Table SK3	Ø: 90cm / 35.4in	3 x Betty (TK1/TK2)

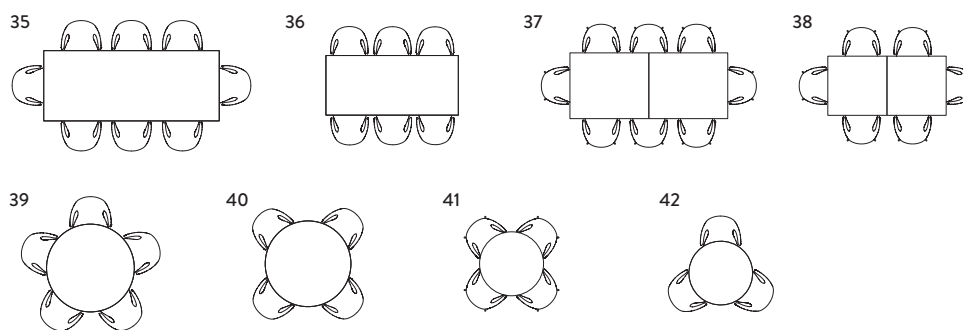

Catch Dining Chair

Product	Size	Chairs
(35) In Between Table SK6	250 x 100cm / 98.4 x 39.3in	8 x Catch (JH1/JH2/JH15)
(36) In Between Table SK5	200 x 90cm / 78.7 x 35.4in	6 x Catch (JH1/JH2/JH15)
(37) Patch Table HW2	240 (+100cm) x 100cm / 94.5 (+39.4in) x 39.4in	8 x Catch (JH1/JH2/JH15) - (extended +2)
(38) Patch Table HW1	180 (+100cm) x 90cm / 70.9 (+39.4in) x 35.4in	6 x Catch (JH1/JH2/JH15) - (extended +2)
(39) In Between Table SK12	Ø: 120cm / 47.2in	5 x Catch (JH1/JH2/JH15)
(40) In Between Table SK4	Ø: 120cm / 47.2in	4 x Catch (JH1/JH2/JH15)
(41) In Between Table SK11	Ø: 90cm / 35.4in	4 x Catch (JH1/JH2/JH15)
(42) In Between Table SK3	Ø: 90cm / 35.4in	3 x Catch (JH1/JH2/JH15)

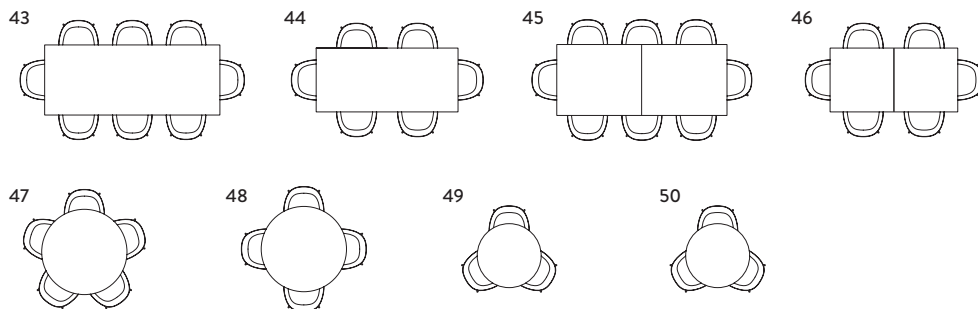

Elefy Dining Chair

Product	Size	Chairs
(43) In Between Table SK6	250 x 100cm / 98.4 x 39.3in	8 x Elefy (JH28 & JH29)
(44) In Between Table SK5	200 x 90cm / 78.7 x 35.4in	6 x Elefy (JH28 & JH29)
(45) Patch Table HW2	240 (+100cm) x 100cm / 94.5 (+39.4in) x 39.4in	8 x Elefy (JH28 & JH29) - (extended +2)
(46) Patch Table HW1	180 (+100cm) x 90cm / 70.9 (+39.4in) x 35.4in	6 x Elefy (JH28 & JH29) - (extended +2)
(47) In Between Table SK12	Ø: 120cm / 47.2in	5 x Elefy (JH28 & JH29)
(48) In Between Table SK4	Ø: 120cm / 47.2in	4 x Elefy (JH28 & JH29)
(49) In Between Table SK11	Ø: 90cm / 35.4in	3 x Elefy (JH28 & JH29)
(50) In Between Table SK3	Ø: 90cm / 35.4in	3 x Elefy (JH28 & JH29)

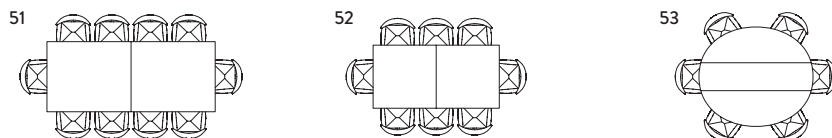

Drawn Dining Chair

Product	Size	Chairs
(51) Patch HW2	240 (+100cm) x 100cm / 94.5 (+39.4in) x 39.4in	10 x Drawn (HM3) / (extended +4)
(52) Patch HW1	180 (+100cm) x 90cm / 70.9 (+39.4in) x 35.4in	8 x Drawn (HM3) / (extended +4)
(53) Drop Leaf HM6	163 x 142cm / 64.2 x 55.9in	6 x Drawn (HM3)

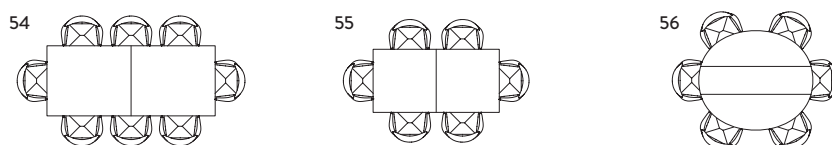

Drawn Armrest Chair

Product	Size	Chairs
(54) Patch HW2	240 (+100cm) x 100cm / 94.5 (+39.4in) x 39.4in	8 x Drawn (HM4) / (extended +2)
(55) Patch HW1	180 (+100cm) x 90cm / 70.9 (+39.4in) x 35.4in	6 x Drawn (HM4) / (extended +2)
(56) Drop Leaf HM6	163 x 142cm / 64.2 x 55.9in	6 x Drawn (HM4)

Spare Parts

Item no.	Product	Colour	Colli qty.	PRICE EX. VAT (SEK)	PRICE INC. VAT (SEK)
91101004	Allwood Chair, Plastic Glider 4 pcs.	Black	2 pcs	112	140
91101005	Allwood Chair, Felt Glider 4 pcs.		2 pcs	112	140
SP28600010	Care Kit, Leather		1 pc	352	440
SP28600005	Care kit, Teak		1 pc	352	440
65002000	Fly seat cushion	COM Fabric	1 pc	4.172	5.215
65002005	Fly seat cushion	Hot Madison, Remix, Re-Wool	1 pc	4.172	5.215
65002006	Fly seat cushion	Canvas, Barnum, Fiord, Hot Madison FR, Ritz	1 pc	5.008	6.260
65002007	Fly seat cushion	Clay, Hallingdal, Steelcut Quartet, Steelcut Trio	1 pc	5.248	6.560
65002008	Fly seat cushion	Acca, Cifrado, Ecriture , Moss, Uniform Melange, Vidar	1 pc	5.844	7.305
65002020	Fly seat cushion	Karakorum, Sisu	1 pc	9.188	11.485
65002025	Fly seat cushion	Fuse, Gentle	1 pc	10.144	12.680
65012000	Fly back cushion	COM Fabric	1 pc	2.500	3.125
65012005	Fly back cushion	Hot Madison, Remix, Re-Wool	1 pc	2.500	3.125
65012006	Fly back cushion	Canvas, Barnum, Fiord, Hot Madison FR, Ritz	1 pc	2.740	3.425
65012007	Fly back cushion	Clay, Hallingdal, Steelcut Quartet, Steelcut Trio	1 pc	2.980	3.725
65012008	Fly back cushion	Acca, Cifrado, Ecriture , Moss, Uniform Melange, Vidar	1 pc	3.100	3.875
65012020	Fly back cushion	Karakorum, Sisu	1 pc	4.772	5.965
65012025	Fly back cushion	Fuse, Gentle	1 pc	5.248	6.560
65022000	Fly small pillow	COM Fabric	1 pc	1.428	1.785
65022005	Fly small pillow	Hot Madison, Remix, Re-Wool	1 pc	1.428	1.785
65022006	Fly small pillow	Canvas, Barnum, Fiord, Hot Madison FR, Ritz	1 pc	1.548	1.935
65022007	Fly small pillow	Clay, Hallingdal, Steelcut Quartet, Steelcut Trio	1 pc	1.664	2.080
65022008	Fly small pillow	Acca, Cifrado, Ecriture , Moss, Uniform Melange, Vidar	1 pc	1.784	2.230
65022020	Fly small pillow	Karakorum, Sisu	1 pc	2.860	3.575
65022025	Fly small pillow	Fuse, Gentle	1 pc	3.216	4.020
65032000	Fly medium pillow	COM Fabric	1 pc	1.904	2.380
65032005	Fly medium pillow	Hot Madison, Remix, Re-Wool	1 pc	1.904	2.380
65032006	Fly medium pillow	Canvas, Barnum, Fiord, Hot Madison FR, Ritz	1 pc	2.144	2.680
65032007	Fly medium pillow	Clay, Hallingdal, Steelcut Quartet, Steelcut Trio	1 pc	2.264	2.830
65032008	Fly medium pillow	Acca, Cifrado, Ecriture , Moss, Uniform Melange, Vidar	1 pc	2.384	2.980
65032020	Fly medium pillow	Karakorum, Sisu	1 pc	3.576	4.470
65032025	Fly medium pillow	Fuse, Gentle	1 pc	3.936	4.920

Material care & cleaning

We challenge convention to create objects that rethink how we use materials and manufacturing techniques. We find beauty in objects that can be created by the latest industrial processes as well as those that maintain techniques that have evolved over a long period of time. We strive for timeless beauty and quality that is made to last.

Find below information about the materials and finishes used in the collection as well as guidelines for daily care, cleaning and maintenance.

Oiled oak & walnut

Oiled oak & walnut, whether solid or veneered, is a fundamental material in the &Tradition collection.

To a greater extent than lacquering and staining, oiling leaves the wood feeling and looking natural and still offers a good surface protection. Oiled wood will develop a natural patina and character over time which will only enhance the beauty of the material.

Solid oak and oak veneer is oiled using either white pigmented oil or a dark smoked oil. The white pigmented oil allows the oak to maintain its original and natural light colour for longer and thereby protects the wood from premature darkening and turning yellow. The smoked oil offers a unique dark finish and character. Variations in wood structure and colour are natural characteristics of solid oak. This feature is further enhanced when applying the smoked oil and should be seen as part of the overall product.

For daily care, dust oiled furniture with a soft dry cloth. Cleaning can be done using a soft cloth wrung in lukewarm water following the wood grain and dried immediately with a soft cloth following the wood grains. For more severe cleaning, a soap specifically developed for oiled wood can be used. Follow the instructions on the packaging of the cleaning product.

Solid walnut or walnut veneer is oiled using a natural coloured oil to maintain its original colour for longer and thereby protect the wood. To maintain the look and silky feeling of oiled wood, regular re-oiling is recommended. Re-oiling should be done when the wood starts to appear dry or faded. Usually, re-oiling once a year is sufficient. Re-oiling walnut can be done by applying standard natural oil for indoorwood products.

Avoid use of cleaning detergents and abrasive cleaning agents as they may damage the surface of the oiled wood. Avoid placing wooden furniture in direct sunlight, excessive heat or humidity.

Lacquered or stained wood

Lacquered or stained wood offers a stronger surface than oiling and is also effective when coloured surfaces are desired. Compared to oiled wood, lacquered and stained wood is easier to clean and requires minimal maintenance.

For daily care it is recommended to dust the furniture with a soft cloth. Lacquered and stained wood can be cleaned with a soft cloth wrung in a mild solution of lukewarm water and a universal cleaning detergent. Always follow the wood grains and always dry with a soft dry cloth immediately after cleaning.

Avoid use of abrasive cleaning agents and aggressive cleaning detergents as this will damage the surface of the lacquered or stained wood. Avoid placing wooden furniture in direct sunlight, excessive heat or humidity.

Linoleum

Tabletops with linoleum offers a soft touch surface that does not feel as cold and hard as laminate. Regular cleaning is done with a soft cloth wrung in a mild solution of lukewarm water and a universal cleaning detergent.

Avoid placing sharp objects on the surface as this may scratch the tabletop. It is recommended to use trivets or coasters under flowerpots, vases, cups etc.

Fenix NTM Nano laminate

Fenix NTM Nano laminate is a soft touch laminate based on nano technology and is used for tabletops as an alternative to linoleum and standard laminate. The nano laminate offers unique features such as scratch resistance, soft touch, low light reflectivity, antifingerprint and much more.

For more details about the unique properties of nano laminate, as well as cleaning and maintenance refer to: www.fenixntm.com/en

Lacquered & Powder coated metal

The majority of the lighting products in the &Tradition collection have a lacquered or powder coated surface.

The True Colour vases have a protective lacquered finish and some furniture has powder coated parts. These surfaces are durable, require no maintenance and offer an endless palette of colours, textures and gloss.

It is recommended only to use a soft, dry cloth to clean lacquered and powder coated surfaces but in case more severe cleaning is necessary, a soft cloth wrung in lukewarm water can be carefully applied. Always dry immediately after cleaning with a soft, dry cloth. Avoid using abrasive cleaning agents or aggressive cleaning detergents on lacquered or powder coated surfaces as this may permanently damage the surface.

Stainless steel

Stainless steel is used on both lighting products and furniture in either a mirror-polished or satin-polished finish. Stainless steel is a classic strong corrosion resistant material that requires no surface protection and will not change appearance over time.

Dust stainless steel products for daily care using only a soft, dry cloth. Cleaning of stainless steel should be done only by using a cleaning detergent specifically for stainless steel. Follow the instructions on the packaging. Cleaning agents not developed specifically for stainless steel may permanently damage the surface of the stainless steel and should never be used.

Brass & Copper

Brass and copper is used for both lighting products and furniture in either a mirror-polished or satin-polished finish. Depending on the product, the brass and copper may be coated using a transparent lacquer or left untreated. Coated brass and copper will not change appearance over time whereas uncoated brass and copper will develop a unique and beautiful patina, over time adding character to the product.

For daily cleaning of coated brass and copper it is recommended only to use a soft dry, cloth. For removal of stains, a soft cloth wrung in lukewarm water can be carefully applied. Always dry immediately after with a soft dry cloth. For daily cleaning of uncoated brass and copper it is recommended only to use a soft, dry cloth. In case a patina of the material is not desired, the material can be regularly cleaned and polished using a detergent specifically for brass and copper.

Avoid using abrasive cleaning agents or aggressive cleaning detergents on coated and uncoated brass and copper as this will permanently damage the surface.

Anodised aluminium

The aluminium used on the column shelves is either anodized black or in a natural

Material care & cleaning

hand polished finish which is treated with a protective wax. Both versions can be cleaned using a soft cloth wrung in lukewarm water. Always dry immediately afterwards with a soft cloth. Avoid use of abrasive cleaning products such as steel wool or polish. Never use aggressive or abrasive cleaning detergents for any parts of the shelf, as this will cause irreparable damage.

Marble & Travertine

Marble and travertine are used in the &Tradition collection on both lighting products and furniture.

The natural material offers a distinctive and exclusive look and two items will never look the same.

The marble and travertine used on &Tradition tabletops are treated with a sealer which makes the tabletop more stain resistant than when left untreated. However, it is strongly recommended to always use a trivet and not to place glasses or cups with liquids directly onto the tabletop. As natural materials, marble & travertine are sensitive to liquids and if not removed immediately, spilled liquids will leave a permanent stain on the tabletop.

For daily care and cleaning it is recommended to use a cleaning agent specifically developed for stone or marble. It is also highly recommended to do a re-sealing of the tabletop approximately every second month using an appropriate sealer developed specifically for stone or marble. The marble used on lighting products has no surface protection and is therefore more exposed to stains and marks. If possible, it is recommended only to clean marble on lighting products with a soft, dry cloth. In case more severe cleaning is necessary, use a cleaning agent specifically developed for stone or marble. Avoid using abrasive cleaning agents or aggressive cleaning detergents on marble as this will permanently damage the surface.

Glass

Glass, in various colours and shapes, is an important material in the &Tradition lighting collection. All glass is mouth-blown and hand crafted which ensures that each item is unique and displays individual characteristics. Examples of characteristics of mouthblown glass are minor air bubbles and variations in form and thickness.

A number of the glass products in the lighting collection are coloured in silver and gold tones using a traditional luster painting technique. Luster is applied with a brush to the clear glass by skilled craftsmen and the glass is subsequently burned at +450°C to melt the luster colour into the glass mass. The process ensures a very smooth and highly scratch resistant surface. Since the entire process of applying the luster is performed by hand, slight deviations in colour may occur from item to item. Daily cleaning of glass is best done using a soft, dry cloth. If more severe cleaning is necessary, it is recommended to use a soft cloth with a standard glass cleaning detergent and then to follow by drying with a soft, dry cloth. Avoid using abrasive cleaning agents on the glass as this will damage the surface.

Collect glassware

Normal dishwasher liquid can be used and all items are dishwasher safe (max. 50°). Do not use any cleaning detergents with harsh chemicals or abrasives.

For more severe cleaning, soaking the product overnight in water and vinegar is recommended.

Mirror

Use household glass cleaner for the mirror. To avoid damaging the surface of the mirror frame, always spray the glass cleaner onto a soft cloth and clean the mirror.

Plastic

For daily cleaning it is recommended to use a soft cloth wrung in lukewarm water. For more severe cleaning a mild detergent can be used. Always dry immediately after.

Upholstery webbing

We recommend maintaining braided upholstery webbing regularly, as dirt and dust etc. will cause wear and tear on the material through use.

General Maintenance

We recommend that you vacuum upholstery webbing once a week using the soft nozzle attachment of your vacuum cleaner (used for textiles and softer furnishings) in order to ensure the longest possible life of the product.

It should not be necessary to clean upholstery webbing often as the material has a slightly dirt-repellent surface.

Stain removal

If an accident occurs and cleaning or stain removal is necessary, the following applies:

- The faster a stain is treated, the greater the possibility that the stain can be removed.
- Spilled liquids should be dabbed – not scrubbed – with a clean, lint-free cloth wrung in clean and lukewarm water, as soon as possible.
- Regardless of the size of the stain, it is important that you clean it working from the outer edge of the stain and move in towards the centre of the stain, so that the damaged area is reduced as much as possible.
- You should not rub or scrub the material as this can damage the material's colour, structure and strength which can worsen the state of the stain.
- If a stain has dried, is from a firmer substance, or has greasy contents, it may be possible to scrape off the stain residue with a blunt knife or a spatula, before continuing any necessary treatment with a suitable stain remover.
- When using a suitable stain remover on a small area, you should carefully follow the manufacturer's instructions for use. It is recommended to test the stain remover on a less visible area of the material first – before cleaning the affected area – to see if the product works as intended, or to see if the product damages the webbing.
- If a stain is very big or has soaked into and through the material, it is recommended to contact a professional furniture cleaner before trying to remove the stain yourself, as it may require a special treatment depending on the nature and location of the stain.

Disclaimer

- Do not use solvents, undiluted detergents, soaps, bleaches or ammonia on the material.
- Please be aware that especially new non-colourfast clothing and dark jeans can potentially leak colour onto the webbing. Any such leakage may not be possible to remove, as the excess colour can soak deep into the material.

Handloomed-woven rugs

The rugs in the &Tradition collection are handmade in India by skilled craftsmen using carefully selected natural materials. Being handmade, each rug will have its own unique character and therefore the patterns and colours of two rugs will never be identical.

A new rug will shed excess fibers that were not fully spun into the yarn during spinning. This is normal and over time, the shedding will lessen and eventually stop.

To prolong the lifetime of a rug, it is highly recommended to use a rug underlay. An underlay ensures that the rug remains in a fixed position and will also reduce the risk of staining.

For daily care, vacuum the rug regularly to keep it free from fluff and dust or sand particles which will wear and tear the rug over time if not removed. Spots can be attempted to be removed by dabbing very gently with a damp cloth soaked in carbonated water. In case more thorough cleaning is necessary, professional cleaning is recommended.

Placing a rug in direct sunlight is not recommended as it will fade the colours of the rug over time.

Sheepskin

Easy on the eye and soft to the touch, sheepskin makes for exceptional and hard-wearing upholstery. It is defined by a dense and curly fleece that comes intact in its most natural form, where pieces are distinctly unique, and their look varies from product to product.

As with most natural materials, differences in structure, density and thickness are expected, as two pieces of sheepskin never look identical and tend to show natural variations in both curls and tones.

Please note that the wool's fibres might naturally become entangled in time. And in regards to colour, each skin's ability to maintain its original tone or absorb applied dye might vary, especially if exposure to sunlight is high. We recommend to keep sheepskin-upholstered products away from direct sunlight to avoid discolouring.

In order to preserve the skin's highly tactile, soft nature, we suggest vacuum cleaning on a weekly basis, and when stained, spots should be soaked with water as promptly as possible. For bigger stains, place a clean towel on the spill and let it absorb as much liquid as possible. For cleaning, we recommend the use of a sponge, lukewarm water and mild wool detergent.

Leather

Imperfect Beauty

High quality, natural leather is not flawless. &Tradition leather, like all other top-quality leather, may have some minor visible marks from the natural life of the animal. These characteristics give each &Tradition leather product a unique beauty and charm but do not affect the overall strength or durability of the product.

&Tradition has distinct quality standards for which these markings are acceptable. Varying degrees of markings are permitted according to how visibly they appear on the product as a whole.

The aniline leather NOBLE is surface treated with a very thin layer of wax which makes it possible for the material to 'breathe'. The semi-aniline leather TAILOR is slightly buffed and lightly surface treated which makes the leather more durable and ensures a higher lightfastness.

Natural Characteristics

Typical natural characteristics which may be visible on the leather are:

- Fat creases
- Neck wrinkles/spine marks
- Healed scars
- Vein marks
- Insect bites
- Slight colour differences from one leather hide to another
- Variation in the natural grain from one hide to another, and sometimes even within a singular hide

Patina

Aniline leather will age beautifully, with each piece gaining its own patina. Over time, the natural leather will continue to develop a slightly different tone and as part of its unique appeal, it will not look exactly the same as on the day it was originally bought.

Before Use

Leather furniture should not be exposed to direct sunlight, positioned close to heat sources or kept in very dry or highly airconditioned environments. This is a natural material which does not perform well when put under these conditions and doing such may result in the leather drying out and becoming stiff and inflexible.

Maintenance

To prolong the life of the leather it is important to frequently vacuum with a soft brush or gently wipe with a soft, dry cloth.

Never use cleaning detergents or sharp objects on the leather as this may damage the surface.

over time they should fade and disappear.

Care

The natural material should be treated with a special aniline leather care cream at least four times a year.

Aniline leather gets dry over time, so it is important to keep the leather conditioned and moisturised to retain optimal softness, flexibility and seating comfort.

Follow the instructions of the special care product; apply cream on a soft, lint-free cloth, massage in light circular motions from seam to seam on the furniture component. Let dry before taking in to use.

Cleaning

Cleaning is done under customer's own responsibility

If leather is soiled, it should be wiped with a soft, clean, damp, lint-free cloth wrung in lukewarm, demineralised water. Alternatively, you can attempt to absorb as much liquid as possible from the soaked leather with a clean kitchen towel.

Do not spot clean leather - clean the entire surface from seam to seam.

Never scrub the leather in an isolated area as this will discolour and tear the material.

If extensive cleaning is needed, it is recommended to use a solution of clean boiled water or demineralised water with a dilution of mild, natural, high-quality soap flakes:

1. Use 0,5DL soap flakes for 1L water. Whip soap flakes in the water until fully dissolved.
2. When the solution is lukewarm, the foam must be gently rubbed onto the leather surface with a soft, clean, cotton cloth using circular motions. It is essential that only the foam from the solution is used. Make sure the foam is equally distributed on the whole surface from seam to seam. Be sure to never soak the surface.
3. When the furniture is dry, the leather should be polished with a very soft, lint-free cloth.
4. After cleaning, it is necessary to apply a special leather care cream.

Large Spills or Damages

If large areas are soiled or the surface is very damaged, contact a professional cleaning firm.

Rattan

In order to retain the strength and flexibility of rattan wicker the material needs to be maintained with a soap treatment 10-12 times a year using the following solution:

- Prepare 1 teaspoon of soap flakes dissolved in 1 litre of lukewarm water.
- Spray the solution on both the front and the back of the rattan and allow it to penetrate.
- If needed, wipe away any leftover liquid with a damp cloth.

Rattan has a delicate white expression when new. This will develop over time, darkening and forming a beautiful patina.

Velvet

Dry stain and soil

On all the articles in our living environment dust and dirt will settle. So it happens also on our upholstered furniture. Do not allow the dust and dirt become to excessive, otherwise it will be more difficult to remove. The upholstered furniture should be cleaned regularly to ensure prolonged life and appearance.

The best way for regular maintenance is: Vacuum cleaning and brushing. Vacuum cleaning and brushing, with a hard cloth brush, always in the direction of the pile naps.

Instead of trying to remove minor spots or stains, they should be left untreated as

To remove stain or in case of fundamental cleaning from your upholstery you better can contact your local upholstery cleaning specialist. You can obtain addresses from your local Consumer Enquiry Office.

They have the experience in dry shampooing and that kind of cleaning processes.

Wet staining

Liquids can be removed by dabbing with paper towel, a clean tea cloth or kitchen towel. Don't rub, only dabbing! For hot liquids you do the same, but there is less rescue time between messing and dabbing. The hot fluid penetrate much quicker in the fabric than cold liquids.

To remove food you scrape the dirt with a spoon or a knife from the fabric and dab the stain with a cold solution of water and detergent. Don't use hot cleaning liquid, because coloured components of the stain will more penetrate the fabric at higher temperature and stay there.

We can't give a general advise about removing Ink, paints, etc. This kind of staining, mostly you can use a solvent as alcohol, dry cleaning solvents ore something like that. Look in a local stain removal advisory table for the best solution.

Note: The S-finish (Teflon) is a release finish with additional a temporary repellent effect, that brings you rescue time between making the mess and removing it. It gives you a delay time, but it don't prevent staining or fouling.

Note: We don't have enough 'local knowledge' about the composition of food, drinks and other frequent used products which may cause staining of your upholstery fabric. Please contact your local cleaning specialist or look at a local website for stain remove advisory tables.

Flatting out pile naps

On velvets, which are not regularly maintained, certain wellworn areas will be formed and will show pile tangling over a period of time. Depending on the colour, you will see it as a change of shade.

By sitting you exert a pressure on the velvet fabric forcing the pile naps in any direction. In combination with heat, the rising air humidity, the body moisture and the kind of filling material under the velvet the changes direction of the pile naps is 'partly fixed'. You can notice this as a change of shade. This is a typical property of velvet fabric and it is neither a defect or a sign of low quality.

You can treat this marks of wear and tear as follows: Take a clean, white/not coloured, warm, damp piece of cloth and lay it several hours or a night over the velvet. The moisture will restore the cotton velvet. The upholstery velvet should not be used before it is complete dry!

Fabric Overview

Manufacturer	Fabric	Martindale	BS 5852 (Part 1)	EN 1021 (Part 1/2)	US. Cal. Bull 117-2013	BS5852 Crib 5.	CRIB 5 Treatable
&Tradition	Noble Aniline leather		•	•	•		
	Tailor Semi-aniline leather		•	•	•		
Dedar	Karakorum	40.000	•	•	•	•	
Elmo Leathers	Elmosoft Semi-aniline		•	•	•	•	
JAB	Hot Madison	55.000	•		•		•
Kvadrat	Acca	50.000	◦	•	•		•
	Canvas	100.000	•	•	•		•
	Cifrado	30.000	◦	•	•		•
	Clay	45.000	•	•			•
	Ecriture	70.000	•	•	•		•
	Fiord	60.000	•	•	•		•
	Fuse	100.000	•	•	•	•	
	Gentle	80.000	•	•	•		•
	Hallingdal	100.000	•	•	•	•	
	Moss	50.000	•	•			•
	Remix	100.000	•	•	•		•
	Re-Wool	100.000	•	•	•		•
	Sisu	70.000	•	•	•		•
	Steelcut Quartet	100.000	•	•	•		•
	Steelcut Trio 3	120.000	•	•	•		•
	Uniform Melange	80.000	•	•	•		•
	Vidar	100.000	•	•	•		•
Nevotex	Ritz	100.000		•			
	Barnum	60.000	•		•		•
Scandilock	Sheepskin		•		•	•	
Sunbrella	Heritage	22.000	◦	◦	•		
	Marquetry	22.000	◦	◦	•		

◦ Pass with treatment.
* Can be tested upon request.

SENAB

22% RABATT SKA DRAS AV PÅ ANGIHVNA PRISER

Packaging Information

Product	Model	Category	Height cm	Width cm	Depth cm	Weight	Colli qty.
Catch	JH1	Chair	90	61	61	15.50 kg	1 pc
Catch	JH2	Chair	90	61	61	16.50 kg	1 pc
Catch	JH15	Chair	90	61	61	15.50 kg	1 pc
Catch	JH13	Lounge Chair	90	84	94	19.00 kg	1 pc
Catch	JH14	Lounge Chair	90	84	94	19.00 kg	1 pc
Catch	JH16	Counter Chair	125	61	61	21.20 kg	1 pc
Catch	JH17	Bar Chair	125	61	61	19.50 kg	1 pc
Elefy	JH28	Chair	83	59	59	9.40 kg	1 pc
Elefy	JH29	Chair	83	59	59	11.20 kg	1 pc
Elefy	JH30	Chair	83	59	59	10.00 kg	1 pc
Elefy	JH31	Chair	83	59	59	11.80 kg	1 pc
Elefy	JH32	Chair	83	59	59	12.20 kg	1 pc
Elefy	JH33	Chair	83	59	59	14.00 kg	1 pc
Elefy	JH34	Chair	83	59	59	12.20 kg	1 pc
Elefy	JH35	Chair	83	59	59	14.00 kg	1 pc
Elefy	JH36	Chair	83	59	59	12.70 kg	1 pc
Elefy	JH37	Chair	83	59	59	14.50 kg	1 pc
In Between	SK1	Chair	95	72	60	13.30 kg	2 pcs
In Between	SK2	Chair	95	72	60	13.80 kg	2 pcs
In Between	SK7	Counter Chair	104	54	60	8.50 kg	1 pc
In Between	SK8	Counter Chair	104	54	60	8.70 kg	1 pc
In Between	SK9	Bar Chair	104	54	60	8.90 kg	1 pc
In Between	SK10	Bar Chair	104	54	60	9.10 kg	1 pc
Pavilion	AV1	Chair	89	55	55	17.40 kg	2 pcs
Pavilion	AV2	Chair with Armrest	87	58	59	19.45 kg	2 pcs
Pavilion	AV3	Chair	89	55	55	18.40 kg	2 pcs
Pavilion	AV4	Chair with Armrest	87	58	59	20.45 kg	2 pcs
Pavilion	AV5	Lounge Chair	70	69	65	8.95 kg	1 pc
Pavilion	AV6	Lounge Chair	70	69	65	8.95 kg	1 pc
Pavilion	AV7	Counter Chair	97	51	53	7.25 kg	1 pc
Pavilion	AV8	Counter Chair	97	51	53	7.35 kg	1 pc
Pavilion	AV9	Bar Chair	95	52	50	7.25 kg	1 pc
Pavilion	AV10	Bar Chair	95	52	50	7.25 kg	1 pc
Pavilion	AV11	Lounge Chair	70	69	65	8.95 kg	1 pc
Pavilion	AV12	Chair	89	55	55	18.40 kg	2 pcs
Pavilion	AV13	Chair with Armrest	87	58	59	20.45 kg	2 pcs
Pavilion	AV14	Counter Chair	97	51	53	7.35 kg	1 pc
Pavilion	AV15	Bar Chair	95	52	50	7.25 kg	1 pc
Rely	HW6	Chair	84	51	60	9.05 kg	1 pc
Rely	HW7	Chair	84	51	60	10.35 kg	1 pc

Packaging Information

Product	Model	Category	Height cm	Width cm	Depth cm	Weight	Colli qty.
Rely	HW8	Chair	84	51	60	9.55 kg	1 pc
Rely	HW9	Chair	84	51	60	10.65 kg	1 pc
Rely	HW10	Chair	84	51	60	10.65 kg	1 pc
Rely	HW11	Chair	84	51	60	11.65 kg	1 pc
Rely	HW12	Chair	84	51	60	12.95 kg	1 pc
Rely	HW13	Chair	84	51	60	12.15 kg	1 pc
Rely	HW14	Chair	84	51	60	13.25 kg	1 pc
Rely	HW15	Chair	84	51	60	13.25 kg	1 pc
Rely	HW16	Chair	84	51	60	11.65 kg	1 pc
Rely	HW17	Chair	84	51	60	12.95 kg	1 pc
Rely	HW18	Chair	84	51	60	12.15 kg	1 pc
Rely	HW19	Chair	84	51	60	13.25 kg	1 pc
Rely	HW20	Chair	84	51	60	13.25 kg	1 pc
Rely	HW21	Chair	84	51	60	11.65 kg	1 pc
Rely	HW22	Chair	84	51	60	12.95 kg	1 pc
Rely	HW23	Chair	84	51	60	12.15 kg	1 pc
Rely	HW24	Chair	84	51	60	13.25 kg	1 pc
Rely	HW25	Chair	84	51	60	13.25 kg	1 pc
Rely	HW26	Chair	84	56	60	8.80 kg	1 pc
Rely	HW27	Chair	84	56	60	8.80 kg	1 pc
Rely	HW28	Chair	82	68	68	12.50 kg	1 pc
Rely	HW29	Chair	82	68	68	13.80 kg	1 pc
Rely	HW30	Chair	82	68	68	13.00 kg	1 pc
Rely	HW31	Chair	82	68	68	14.10 kg	1 pc
Rely	HW32	Chair	82	68	68	14.10 kg	1 pc
Rely	HW33	Chair	85	62	62	10.90 kg	1 pc
Rely	HW34	Chair	85	62	62	12.10 kg	1 pc
Rely	HW35	Chair	85	62	62	5.70 kg	1 pc
Rely	HW36	Chair	85	62	62	6.80 kg	1 pc
Rely	HW37	Chair	85	62	62	6.80 kg	1 pc
Rely	HW38	Chair	85	62	62	13.40 kg	1 pc
Rely	HW39	Chair	85	62	62	14.70 kg	1 pc
Rely	HW40	Chair	85	62	62	9.40 kg	1 pc
Rely	HW41	Chair	85	62	62	9.40 kg	1 pc
Rely	HW42	Chair	85	62	62	9.40 kg	1 pc
Rely	HW43	Chair	85	62	62	13.40 kg	1 pc
Rely	HW44	Chair	85	62	62	14.70 kg	1 pc
Rely	HW45	Chair	85	62	62	8.30 kg	1 pc
Rely	HW46	Chair	85	62	62	9.40 kg	1 pc
Rely	HW47	Chair	85	62	62	9.40 kg	1 pc

22% RABATT SKA DRAS AV PÅ ANGIVNA PRISER

Packaging Information

Product	Model	Category	Height cm	Width cm	Depth cm	Weight	Colli qty.
Rely	HW48	Chair	85	62	62	13.40 kg	1 pc
Rely	HW49	Chair	85	62	62	14.70 kg	1 pc
Rely	HW50	Chair	85	62	62	8.30 kg	1 pc
Rely	HW51	Chair	85	62	62	9.40 kg	1 pc
Rely	HW52	Chair	85	62	62	9.40 kg	1 pc
Rely	HW53	Chair	85	62	62	14.50 kg	1 pc
Rely	HW54	Chair	85	62	62	15.80 kg	1 pc
Rely	HW55	Chair	85	68	68	9.40 kg	1 pc
Rely	HW56	Chair	85	68	68	10.50 kg	1 pc
Rely	HW57	Chair	85	68	68	10.50 kg	1 pc
Rely	HW65	Chair	84	56	60	14.20 kg	2 pcs
Rely	HW66	Chair	84	56	60	16.20 kg	2 pcs
Rely	HW67	Chair	84	56	60	15.60 kg	2 pcs
Rely	HW68	Chair	84	56	60	17.80 kg	2 pcs
Rely	HW69	Chair	84	56	60	17.80 kg	2 pcs
Rely	HW71	Chair	84	51	60	5.68 kg	1 pc
Rely	HW72	Chair	84	51	60	6.48 kg	1 pc
Rely	HW73	Chair	84	51	60	6.18 kg	1 pc
Rely	HW74	Chair	84	51	60	7.28 kg	1 pc
Rely	HW75	Chair	84	51	60	7.28 kg	1 pc
Rely	HW76	Chair	85	62	62	7.04 kg	1 pc
Rely	HW77	Chair	85	62	62	8.24 kg	1 pc
Rely	HW78	Chair	85	62	62	7.74 kg	1 pc
Rely	HW79	Chair	85	62	62	7.98 kg	1 pc
Rely	HW80	Chair	85	62	62	7.98 kg	1 pc
Rely	HW81	Counter stool	81	46	47	6.98 kg	1 pc
Rely	HW82	Counter stool	81	46	47	7.73 kg	1 pc
Rely	HW83	Counter stool	81	46	47	7.28 kg	1 pc
Rely	HW84	Counter stool	81	46	47	7.93 kg	1 pc
Rely	HW85	Counter stool	81	46	47	7.93 kg	1 pc
Rely	HW86	Bar stool	91	46	47	7.22 kg	1 pc
Rely	HW87	Bar stool	91	46	47	7.97 kg	1 pc
Rely	HW88	Bar stool	91	46	47	7.52 kg	1 pc
Rely	HW89	Bar stool	91	46	47	8.17 kg	1 pc
Rely	HW90	Bar stool	91	46	47	8.17 kg	1 pc
Rely	HW91	Counter chair	103	51	55	9.42 kg	1 pc
Rely	HW92	Counter chair	103	51	55	10.22 kg	1 pc
Rely	HW93	Counter chair	103	51	55	9.92 kg	1 pc
Rely	HW94	Counter chair	103	51	55	11.02 kg	1 pc

Packaging Information

Product	Model	Category	Height cm	Width cm	Depth cm	Weight	Colli qty.
Rely	HW95	Counter chair	103	51	55	11.02 kg	1 pc
Rely	HW96	Bar chair	113	51	55	9.74 kg	1 pc
Rely	HW97	Bar chair	113	51	55	10.54 kg	1 pc
Rely	HW98	Bar chair	113	51	55	10.24 kg	1 pc
Rely	HW99	Bar chair	113	51	55	11.34 kg	1 pc
Rely	HW100	Bar chair	113	51	55	11.34 kg	1 pc
Rely	HW101	Lounge Chair	77	62	62	6.42 kg	1 pc
Rely	HW102	Lounge Chair	77	62	62	7.62 kg	1 pc
Rely	HW103	Lounge Chair	77	62	62	7.12 kg	1 pc
Rely	HW104	Lounge Chair	77	62	62	7.36 kg	1 pc
Rely	HW105	Lounge Chair	77	62	62	7.36 kg	1 pc
Betty	TK1	Stackable Chair	86	52	52	9.95 kg	2 pcs
Betty	TK2	Stackable Chair	86	52	52	12.15 kg	2 pcs
Betty	TK3	Chair	86	53	52	13.15 kg	2 pcs
Betty	TK9	Chair	90	50	62.5	11.20 kg	2 pcs
Betty	TK10	Chair	90	50	62.5	11.20 kg	2 pcs
Betty	TK11	Chair	90	50	62.5	14.50 kg	2 pcs
Betty	TK4	Bench	8	108	38	7.40 kg	1 pc
Betty	TK5	Bench	8	159	38	9.80 kg	1 pc
Betty	TK7	Stool	70	42	42	4.90 kg	1 pc
Betty	TK8	Stool	80	42	42	4.90 kg	1 pc
Allwood	AV35	Chair	91	51	60	13.40 kg	2 pcs
Allwood	AV36	Stacking trolley	57	76,2	54,8	13.40 kg	1 pc
Wire stool	VP11	Stool	47	46	46	3.80 kg	1 pc
Wire stool cushion	VP11	Cushion	4.5	38	38	0.60 kg	1 pc
Boomerang	HM1	Lounge Chair	81	79	80	8.00 kg	1 pc
Boomerang	HM2	Lounge Chair	81	79	80	9.00 kg	1 pc
X chair	HM10	Lounge Chair	80	81	69	14.15 kg	1 pc
Ax chair	HM11	Lounge chair	80	67	80	11.34 kg	1 pc
Drawn	HM3	Chair	78	46	49	6.50 kg	1 pc
Drawn	HM4	Chair	78	46	54	8.70 kg	1 pc
Little Petra	VB1	Lounge Chair	88	88	88	27.20 kg	1 pc
Little Petra	VB2	Sofa	85	150	78	43.10 kg	1 pc
Petra	VB3	Lounge chair	110	85	95	35.76 kg	1 pc
Little Petra & Pouf	VB1 & ATD1	Lounge chair & Pouf	80	88	88	32.30 kg	1 pc
Pouf	ATD1	Pouf	41	53	53	6.80 kg	1 pc
Wuff	ATD2	Lounge Chair	90	91	93	15.00 kg	1 pc

Packaging Information

Product	Model	Category	Height cm	Width cm	Depth cm	Weight	Colli qty.
Wulff	ATD3	Pouf	42	55	60	8.50 kg	1 pc
Wulff	ATD2 & ATD3	Lounge Chair & Pouf	90	91	93	32.60 kg	1 pc
Loafer	SC23	Lounge Chair	80	75	75	31.50 kg	1 pc
Loafer	SC24	Chair	80	65	65	33.20 kg	1 pc
Loafer	SC25	Sofa	80	153	73	43.80 kg	1 pc
Loafer	SC26	Sofa	80	188	73	54.10 kg	1 pc
Margas	LC1	Lounge Chair	81	95	95	26.00 kg	1 pc
Margas	LC2	Lounge Chair	81	95	95	32.00 kg	1 pc
Margas	LC3	Sofa	81	165	95	38.00 kg	1 pc
Mayor	AJ5	Sofa	80	211	73	82.00 kg	1 pc
Mayor	AJ6	Sofa	80	150	74	57.00 kg	1 pc
Cloud	LN1	Lounge Chair	75	89	108	63.80 kg	1 pc
Cloud	LN2	Sofa	75	90	179	83.95 kg	1 pc
Cloud	LN3.2	Sofa	76	90	228	102.40 kg	1 pc
Cloud High Back	LN5	Lounge Chair	120	109	90	73.80 kg	1 pc
Cloud High Back	LN6	Sofa	120	179	90	98.25 kg	1 pc
Cloud High Back	LN7	Sofa	120	229	90	118.70 kg	1 pc
Inland	AV22	Sofa	69	102	182	78.10 kg	1 pc
Inland	AV23	Sofa	69	104	231	92.00 kg	1 pc
Inland	AV21	Lounge Chair	73	104	97	66.00 kg	1 pc
Inland	AV32	Pouf	43	109	82	46.00 kg	1 pc
Develius	EV5	Modular Sofa	50	80	17	6.05 kg	1 pc
Develius	EV6	Modular Sofa	50	50	15	3.10 kg	1 pc
Develius	EV7	Modular Sofa	35	50	13	1.70 kg	1 pc
Develius	EVIA	Modular Sofa	74	114	93	57.10 kg	1 pc
Develius	EV1B	Modular Sofa	74	114	93	57.10 kg	1 pc
Develius	EVIC	Modular Sofa	74	94	94	42.35 kg	1 pc
Develius	EVID	Modular Sofa	74	94	94	42.35	1 pc
Develius	EVIE	Modular Sofa	46	93	93	31.50 kg	1 pc
Develius	EVIF	Modular Sofa	74	114	93	57.10 kg	1 pc
Develius	EVIG	Modular Sofa	74	114	93	57.10 kg	1 pc
Develius	EVIH	Modular Sofa	74	115	155	79.40 kg	1 pc
Develius	EVII	Modular Sofa	74	115	155	79.40 kg	1 pc
Develius	EV1J	Modular Sofa	74	114	93	57.10 kg	1 pc
Develius	EV1K	Modular Sofa	74	114	93	57.10 kg	1 pc
Develius	EV2A	Modular Sofa	74	135	112	71.70 kg	1 pc
Develius	EV2B	Modular Sofa	74	135	112	71.70 kg	1 pc
Develius	EV2C	Modular Sofa	74	115	115	64.90 kg	1 pc
Develius	EV2D	Modular Sofa	74	115	115	65.90 kg	1 pc
Develius	EV2E	Modular Sofa	46	114	112	38.90 kg	1 pc

Packaging Information

Product	Model	Category	Height cm	Width cm	Depth cm	Weight	Colli qty.
Develius	EV2F	Modular Sofa	74	135	112	65.70 kg	1 pc
Develius	EV2G	Modular Sofa	74	135	112	65.70 kg	1 pc
Develius	EV2J	Modular Sofa	74	135	112	71.70 kg	1 pc
Develius	EV2K	Modular Sofa	74	135	112	71.70 kg	1 pc
Develius	EV8A	Modular Sofa	74	114	93	57.10 kg	1 pc
Develius	EV8B	Modular Sofa	74	114	93	57.10 kg	1 pc
Develius	EV8C	Modular Sofa	74	94	94	42.35 kg	1 pc
Develius	EV8D	Modular Sofa	74	94	94	42.35 kg	1 pc
Develius	EV8E	Modular Sofa	46	93	93	31.50 kg	1 pc
Develius	EV8F	Modular Sofa	74	114	93	57.10 kg	1 pc
Develius	EV8G	Modular Sofa	74	114	93	57.10 kg	1 pc
Develius	EV8H	Modular Sofa	74	115	155	79.40 kg	1 pc
Develius	EV8I	Modular Sofa	74	115	155	79.40 kg	1 pc
Develius	EV8J	Modular Sofa	74	114	93	57.10 kg	1 pc
Develius	EV8K	Modular Sofa	74	114	93	57.10 kg	1 pc
Isole	NNIA	Modular Sofa	26.5	66.5	66.5	9.50 kg	1 pc
Isole	NN1B	Modular Sofa	22.5	61.5	67.5	8.30 kg	1 pc
Isole	NN1C	Modular Sofa	22.5	46.6	68	6.90 kg	1 pc
Isole	NN1D	Modular Sofa	3	31	31	1.50 kg	1 pc
Isole	NN1E	Modular Sofa	3	21	65.5	2.35 kg	1 pc
Isole	NN1F	Modular Sofa	3	66	66	7.70 kg	1 pc
Isole	NN1G	Modular Sofa	7	4	4	0.50 kg	1 pc
Fly	SC10	Lounge Chair	53	75	75	28.80 kg	1 pc
Fly	SC1	Lounge Chair	53	91	84	35.10 kg	1 pc
Fly	SC2	Sofa	53	166	84.5	63.80 kg	1 pc
Fly	SC3	Sofa	53	240.5	84.5	77.25 kg	1 pc
Fly	SC12	Sofa	53	240.5	84.5	76.75 kg	1 pc
Fly	SC9	Pouf Base	11	85	96	14.60 kg	1 pc
Fly	SC9	Pouf Pillow	20	80	80	8.00 kg	1 pc
Fly	SC4	Table Top	8	88	88	41.90 kg	1 pc
Fly	SC4	Table Base	11	85	96	14.60 kg	1 pc
Fly	SC5	Table Top	8	67	128	59.90 kg	1 pc
Fly	SC5	Table Base	7	75	126	15.90 kg	1 pc
Fly	SC11	Table Top	15	136	136	92.90 kg	1 pc
Fly	SC11	Table Base	9	125	135	48.00 kg	1 pc
Sett	LN11	Sett frame	13.5	19	55.5	4.00 kg	1 pc
Sett	LN11	Sett marble table top	8	48	48	11.00 kg	1 pc
Sett	LN11	Sett glass table top	8	48	48	13.00 kg	1 pc
Sett	LN12	Sett frame	13.5	19	136.5	7.10 kg	1 pc
Sett	LN12	Sett marble table top	8	148	68	56.00 kg	1 pc

Packaging Information

Product	Model	Category	Height cm	Width cm	Depth cm	Weight	Colli qty.
Sett	LN12	Sett glass table top	8	148	68	65.00 kg	1 pc
Sett	LN13	Sett frame	13.5	19	96.5	6.70 kg	1 pc
Sett	LN13	Sett marble table top	8	108	108	66.00 kg	1 pc
Sett	LN13	Sett glass table top	8	108	108	78.00 kg	1 pc
In Between	SK3/SK11	Table Top	4.5	92	92	19.95 kg	1 pc
In Between	SK3	Table Legs	25.5	81	23	8.60 kg	1 pc
In Between Center Base	SK11	Support	60	60	5	8.30 kg	1 pc
In Between Center Base	SK11	Column	75	19	19	8.00 kg	1 pc
In Between Center Base	SK11	Base	60	60	5	20.00 kg	1 pc
In Between	SK4/SK12	Table Top	4.5	122.5	120	37.50 kg	1 pc
In Between	SK4	Table Legs	25.5	81	23	10.10 kg	1 pc
In Between Center Base	SK12	Support	5	75	75	16.00 kg	1 pc
In Between Center Base	SK12	Column	75	19	19	8.00 kg	1 pc
In Between Center Base	SK12	Base	5	75	75	24.00 kg	1 pc
In Between	SK23	Lounge table	7	65	125	11.3 kg	1 pc
In Between	SK24	Lounge table	7	105	105	16.8 kg	1 pc
In Between	SK5	Table Top	10	100	215	50.00 kg	1 pc
In Between	SK5	Table Legs	20	78	87	13.00 kg	1 pc
In Between	SK6	Table Top	10	110	265	67.80 kg	1 pc
In Between	SK6	Table Legs	20	78	97	13.50 kg	1 pc
In Between	SK13	Lounge table	7	63	63	5.05 kg	1 pc
In Between	SK14	Lounge table	7	75	75	7.15 kg	1 pc
In Between	SK15	Lounge table	7	105	105	15.35 kg	1 pc
In Between	SK16	Table top - Marble	8	80	70	40.00 kg	1 pc
In Between	SK16, SK21	Table top - Fenix	5	64	74	15.00 kg	1 pc
In Between	SK17, SK22	Table top - Fenix	5	64	64	14.00 kg	1 pc
In Between	SK18	Table top - Marble	8	100	100	61.00 kg	1 pc
In Between	SK19	Table top - Marble	8	130	130	104.00 kg	1 pc
In Between	SK20	Table top - Marble	8	160	160	160.00 kg	1 pc
In Between	SK21	Table top - Marble	8	80	70	40.00 kg	1 pc
In Between	SK16, SK17, SK21, SK22	Support	5	50	50	6.20 kg	1 pc
In Between	SK18	Support	5	60	60	9.00 kg	1 pc
In Between	SK19 & SK20	Support	5	75	75	14.90 kg	1 pc
In Between	SK16 & SK17	Column	10	75	10	1.70 kg	1 pc
In Between	SK18	Column	15	76	15	5.50 kg	1 pc
In Between	SK19 & SK20	Column	18	76	18	6.00 kg	1 pc
In Between	SK21 & SK22	Column	5	105	10	2.50 kg	1 pc
In Between	SK16, SK17, SK21, SK22	Base	5	50	50	12.50 kg	1 pc
In Between	SK18	Base	5	60	60	18.40 kg	1 pc
In Between	SK19 & SK20	Base	5	75	75	29.70 kg	1 pc

Packaging Information

Product	Model	Category	Height cm	Width cm	Depth cm	Weight	Colli qty.
Patch	HW1	Extendable Table	14	97	187	90.25 kg	1 pc
Patch	HW2	Extendable Table	14	107	247	110.70 kg	1 pc
Drip	HW58	Table Top	7	84	144	19.9 kg	1 pc
Drip	HW58	Legs	8	234	26	12.3 kg	1 pc
Drip	HW59	Table Top	7	84	194	23.2 kg	1 pc
Drip	HW59	Legs	8	234	26	13.7 kg	1 pc
Drip	HW60	Table Top	7	104	250	39.4 kg	1 pc
Drip	HW60	Legs	8	234	26	16 kg	1 pc
Drip	HW61	Table top	7	54	194	13.9 kg	1 pc
Drip	HW61	Legs	16	184	27	19.9 kg	1 pc
Drip	HW62	Table Top	7	84	194	23.2 kg	1 pc
Drip	HW62	Legs	16	184	27	21.7 kg	1 pc
Drip	HW63	Table top	7	54	194	13.9 kg	1 pc
Drip	HW63	Legs	16	184	27	20.2 kg	1 pc
Drip	HW64	Table top	7	84	194	23.2 kg	1 pc
Drip	HW64	Legs	16	184	27	22 kg	1 pc
Drip	HW111	Table top	7	54	144	10.3 kg	1 pc
Drip	HW111	Legs	16	184	27	17.8 kg	1 pc
Drip	HW112	Table top	7	54	144	16.9 kg	1 pc
Drip	HW112	Legs	16	184	27	19.8 kg	1 pc
Drip	HW113	Table top	7	54	144	10.3 kg	1 pc
Drip	HW113	Legs	16	184	27	18.3 kg	1 pc
Drip	HW114	Table top	7	84	144	16.9 kg	1 pc
Drip	HW114	Legs	16	184	27	19.9 kg	1 pc
Pavilion	AV16	Table Top + Stretcher	8	75	145	21.1 kg	1 pc
Pavilion	AV16	Frame	11	66	82	11.1 kg	1 pc
Pavilion	AV17	Table Top + Stretcher	19	75	145	22.1 kg	1 pc
Pavilion	AV17	Frame	11	66	82	11.1 kg	1 pc
Pavilion	AV18	Table	7.2	166	96	33.6 kg	1 pc
Pavilion	AV19	Table	7.2	206	96	44.0 kg	1 pc
Pavilion	AV24	Table	7.2	256	116	53.60 kg	1 pc
Drop Leaf	HM5	Side Table	15	85	86	17.95 kg	1 pc
Drop Leaf	HM6	Dining Table	53	142	163	51.60 kg	1 pc
Pinwheel	HM7	Table	5	71	79	6.55 kg	1 pc
Lato	LN8	Lounge Table Top	9	44	42	5.40 kg	1 pc
Lato	LN8	Wood Table Top	10	70	50	4.20 kg	1 pc
Lato	LN9	Lounge Table Top	9	54	42	6.20 kg	1 pc
Lato	LN9	Wood Table Top	10	70	50	4.20 kg	1 pc
Lato	LN8 & LN9	Side Table Base	30	30	30	16.00 kg	1 pc

Packaging Information

Product	Model	Category	Height cm	Width cm	Depth cm	Weight	Colli qty.
Tung	JA3	Side table	54.5	41	41	13.42 kg	1 pc
Rotate	SC73	Trolley	64	39	39	18.4 kg	1 pc
Alima Trolley	NDS1	Trolley	63	97	46	14.5 kg	1 pc
Alima Tray	NDS1	Trolley Tray	5	51	48.5	2.8 kg	1 pc
Palette	JH7	Lounge Table	50	70	126	28.40 kg	1 pc
Palette	JH9	Desk	88	145	67	32.25 kg	1 pc
Palette	JH25	Lounge Table	48	107	120	49.50 kg	1 pc
Shuffle	MH1	Table	20	79	48	14.70 kg	1 pc
Halten	SH9	Table Warm Black frame	56.5	40.5	46.5	4.56 kg	1 pc
Halten	SH9	Table Warm Black frame	56.5	40.5	46.5	4.52 kg	1 pc
Halten	SH9	Table marble top	6.5	41	39	3.17 kg	1 pc
Halten	SH9	Table glass top	6.5	41	39	2.92 kg	1 pc
Thorvald	SC94	Sidechair	88.5	66	55.5	17.30 kg	2 pcs
Thorvald	SC95	Armchair	88.5	66	65	20.60 kg	2 pcs
Thorvald	SC94/SC95	Cushion	85	57	52	7.50 kg	9 pcs
Thorvald	SC94/SC95	Seat pad	85	57	52	6.65 kg	15 pcs
Thorvald	SC96	Café table top	5.5	76	76	7.80 kg	1 pc
Thorvald	SC96/SC97	Café table frame	8.5	81	66.5	9.40 kg	1 pc
Thorvald	SC97	Café table top	5.5	79	79	10.50 kg	1 pc
Thorvald	SC98	Dining table top	5.5	123.5	122	19.10 kg	1 pc
Thorvald	SC98	Dining table frame	21	100.5	87	17.00 kg	1 pc
Thorvald	SC102	Side table	51.5	45	45	6.10 kg	1 pc
Thorvald	SC100	Lounge side chair	65	82.5	82.5	21.00 kg	1 pc
Thorvald	SC101	Lounge arm chair	74	82.5	82.5	24.20 kg	1 pc
Thorvald	SC100/SC101	Cushion	85	57	52	8.89 kg	9 pcs
Thorvald	SC100/SC101	Seat pad	85	57	52	7.9 kg	15 pcs

Packaging Information

Product	Model	Category	Height cm	Width cm	Depth cm	Weight	Colli qty.
Capture	SC77	Coat Stand	14	41	189	8.50 kg	1 pc
Cruise							
Amore	SC49	Mirror	122	122	13	47.50 kg	1 pc
Amore	SC50	Mirror	197	67	13	49.50 kg	1 pc
Amore	SC56	Mirror	80	80	8	12.5kg	1 pc
Sillon	SH4	Mirror	9	54	54	5.40 kg	1 pc
Sillon	SH5	Mirror	9	74	74	9.30 kg	1 pc
Sillon	SH6	Mirror	9	104	104	16.80 kg	1 pc
Sillon	SH7	Mirror	11	71	201	55.90 kg	1 pc

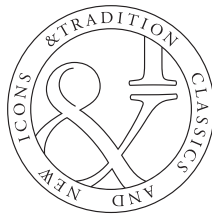

&Tradition
Anker Heegaards Gade 8
DK-1572 Copenhagen
info@andtradition.com
andtradition.com

©&Tradition 2024
#andtradition

SENAB

22% RABATT SKA DRAS AV PÅ ANGIVNA PRISER

&Tradition®

SENAB

22% RABATT SKA DRAS AV PÅ ANGIVNA PRISER