

Möten och paus-23.3-5834-2022-011
Sono Sverige AB produktlista 1

Price List

2024



ocee & four
DESIGN

20% rabatt ska dras av på angivna priser

Hello, we are Ocee & Four Design!

We are on a mission to turn every good space into a great experience. Experience is about connecting with people, and that is why our furniture is designed with people in mind: How do they connect with others? What inspires and engages them? Where do they feel most comfortable? Who do they spend their time with? Why do they work in the way they do? These questions form the basis of the creative, comfortable, and productive spaces we work with our partners to create.

Our furniture solutions and products are highly curated to suit a variety of needs and spaces. We believe nothing beats family, and our products reflect that. You will find solutions that work together in perfect harmony to create beautiful spaces, while also maintaining their individual characteristics as standalone designs.

Ingenious design, unrivalled functionality, a focus on people, and a healthy dose of wonder – this is how we turn good spaces into great experiences.

20% rabatt ska dras av på angivna priser

FourSure® Family ↗



EU Ecolabel
FourSure®



FourSure® 44



FourSure® 88



FourSure® 90/105



FourSure® 66



FourSure® 77



FourSure® 11



FourSure® 99

FourCast® 2 Family ↗



EU Ecolabel
FourCast® 2



FourCast® 2 Four



FourCast® 2 Line



FourCast® 2 Counter /
High



FourCast® 2 Counter
Four / High Four



FourCast® 2 Wheeler



FourCast® 2 77



FourCast® 2 One



FourCast® 2 Fire
Retardant

20% rabatt ska dras av på angivna priser

FourMe® Family ↗



FourMe® 44



FourMe® 88



FourMe® 66

Share Family ↗



Share Basic



Share Stool



Share Bench

Upholstered Stools ↗



Casino

20% rabatt ska dras av på angivna priser

FourReal® Table Family ↗



FourReal® 74



FourReal® 74i Flake



FourReal® Flex



FourReal® 90



FourReal® 105



FourReal® A 74 /
A XL 74



FourReal® A Flex



FourReal® A 90 /
A XL 90



FourFold®



Acoustic Panels



Tray



Power Cube

Four® Tables ↗



Four® Learning



Four® Eating



Four® Meeting



Four® Standing
90 / 103



Four® Resting
H 51 / 64 / 72,5 / 103



Y-Table

20% rabatt ska dras av på angivna priser

Soft seating [↗](#)



FourPeople®
Family



FourLikes®
Family



FourUs®
Family



Harc
Family

Acoustic [↗](#)



InnoPod®

Links

[Sustainability \[↗\]\(#\)](#)

[Certificates \[↗\]\(#\)](#)

[Electrical accessories \[↗\]\(#\)](#)

[Accessories \[↗\]\(#\)](#)





[Colour codes \[↗\]\(#\)](#)

[Fabric bands \[↗\]\(#\)](#)

[Terms & Conditions \[↗\]\(#\)](#)

[Contact \[↗\]\(#\)](#)

Environmental Symbols

-  Eco-labelled product
-  Sustainability-marked product or component
-  Climate calculated product
-  Product that contains recycled or renewable material
-  Disassembled product

20% rabatt ska dras av på angivna priser



FEATURES



- The chair consists of 50 % recycled plastic
- Limitation of substances that are harmful to health and the environment
- Linking device optional on frames or under seat
- Matches table height 74 cm, 90 cm & 105 cm
- Polyamide glides as standard
- Stackable on matching trolley

For product information visit oceefour.com ↗

SHELL COLOURS

Standard Polypropylene



FRAME COLOURS









Standard

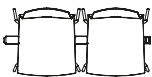

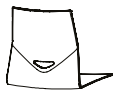
For full colour details [go to page 250](#) ↗

Product	Description (Item nr)	Weight (Kg)	Stacking on floor	Dimensions (mm)	Band	Standard PP (SEK)
	22500 FourSure® 44, Polypropylene shell	5	-		-	2.020
	23200 FourSure® 88, Polypropylene shell	6	-		-	2.479
	23800 FourSure® 90, Polypropylene shell	6.9	-		-	3.409
	23900 FourSure® 105, Polypropylene shell	7.7	-		-	3.492

Design by Strand+Hvass

ACCESSORIES	Description	Weight (Kg)	Dimensions (mm)	Price (SEK)
	CHAIR FEET Felt glides, set of 4 pcs. height + 0,2 cm	1,82 g x 4		208
	CHAIR FEET Teflon glides, set of 4 pcs. Chair height + 0,2 cm	2,75 g x 4		208
	LINKING DEVICE Chair linking	0,4 KG	C/C 535 mm C/C with armrest 585 mm C/C with Loop armrest 625 mm	417
	LINKING DEVICE Chair linking		C/C 540 mm C/C with armrest 540 mm	390
	GRIP HOLE Available for chairs without inside – and full upholstery			189
	SEAT ROW NUMBER - ACSR0201 11 mm - no. 1 -25	29 g		1.579
	SEAT ROW NUMBER - ACSR0202 11 mm - no. 26 -50	29 g		1.579
	SEAT ROW NUMBER - ACSR0101 16 mm - no. 1 -25	29 g		1.579
	SEAT ROW NUMBER - ACSR0102 16 mm - no. 26 -50	29 g		1.579
	CHAIR TROLLEY - 200X0 28 chairs without upholstery	33,5 Kg	1100 x 560 x 1970 mm	8.859



FEATURES

- Armrest options and wooden legs options*
- Linking device under seat options
- Monochrome powder coating on frames options
- Polyamide glides as standard
- Inno® Note tablet options
- Stackable on matching trolley
- Outdoor options
- We do not recommend suspensions for fully upholstered version



For product information visit oceefour.com ↗

SHELL COLOURS

Standard Polypropylene



FRAME COLOURS

Standard



Optional Polypropylene

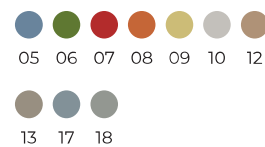



Frame optional*







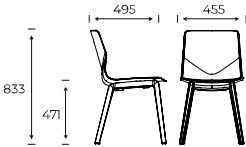

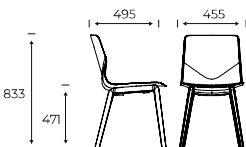
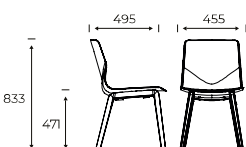

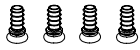
For full colour details [go to page 250](#) ↗

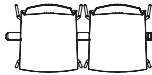
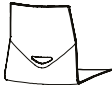
Product	Description (Item nr)	Weight (Kg)	Stacking on floor	Dimensions (mm)	Band	Standard PP (SEK)	Optional PP (SEK)
	22500 FourSure® 44, Polypropylene shell	5	12		-	2.020	2.211
	22510 FourSure® 44, Seat pad	5.9	10		1 2 3 4 5 6 7 8 10	3.282 3.377 3.472 3.566 3.658 3.754 3.849 3.943 4.161	3.473 3.568 3.663 3.757 3.849 3.945 4.040 4.134 4.352
	22520 FourSure® 44, Inside upholstery	6.3	8		1 2 3 4 5 6 7 8 10	4.438 4.629 4.821 5.010 5.202 5.393 5.584 5.774 6.158	4.629 4.820 5.012 5.201 5.393 5.584 5.965 6.349
	22530 FourSure® 44, Fully upholstered	5.7	6		1 2 3 4 5 6 7 8 10	4.719 4.940 5.161 5.382 5.601 5.824 6.044 6.265 6.748	

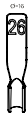
Product	Description (Item nr)	Weight (Kg)	Stacking on floor	Dimensions (mm)	Band	Standard PP (SEK)	Optional PP (SEK)
	22600 FourSure® 44 with Armrests, Polypropylene shell	5.6	12		-	3.174	3.365
	22610 FourSure® 44 with Armrests, Seat pad	6.4	10		1 2 3 4 5 6 7 8 10	4.436 4.531 4.626 4.720 4.812 4.908 5.003 5.097 5.315	4.627 4.722 4.817 4.911 5.003 5.099 5.194 5.288 5.506
	22620 FourSure® 44 with Armrests, Inside upholstery	6.8	8		1 2 3 4 5 6 7 8 10	5.592 5.783 5.975 6.164 6.356 6.547 6.738 6.928 7.312	5.783 5.974 6.166 6.355 6.547 6.738 6.929 7.119 7.503
	22630 FourSure® 44 with Armrests, Fully upholstered	6.2	6		1 2 3 4 5 6 7 8 10	5.873 6.094 6.315 6.536 6.755 6.978 7.198 7.419 7.902	
	22700 FourSure® 44 with Loop Armrests, Polypropylene shell	6.1	12		-	3.174	3.365
	22710 FourSure® 44 with Loop Armrests, Seat pad	6.9	10		1 2 3 4 5 6 7 8 10	4.436 4.531 4.626 4.720 4.812 4.908 5.003 5.097 5.315	4.627 4.722 4.817 4.911 5.003 5.099 5.194 5.288 5.506
	22720 FourSure® 44 with Loop Armrests, Inside upholstery	7.3	8		1 2 3 4 5 6 7 8 10	5.592 5.783 5.975 6.164 6.356 6.547 6.738 6.928 7.312	5.783 5.974 6.166 6.355 6.547 6.738 6.929 7.119 7.503
	22730 FourSure® 44 with Loop Armrests, Fully upholstered	6.8	6		1 2 3 4 5 6 7 8 10	5.873 6.094 6.315 6.536 6.755 6.978 7.198 7.419 7.902	

Product	Description (Item nr)	Weight (Kg)	Stacking on floor	Dimensions (mm)	Band	Standard PP (SEK)	Optional PP (SEK)
	22500 FourSure® 44, Polypropylene shell, Oak lacquered	5	-		-	3.748	3.939
	22510 FourSure® 44, Seat pad, Oak lacquered	5.9	-		1 2 3 4 5 6 7 8 10	5.010 5.105 5.200 5.294 5.386 5.482 5.577 5.671 5.889	5.201 5.296 5.391 5.485 5.577 5.673 5.768 5.862 6.080
	22520 FourSure® 44, Inside upholstery, Oak lacquered	6.3	-		1 2 3 4 5 6 7 8 10	6.166 6.357 6.549 6.740 6.930 7.121 7.312 7.503 7.886	6.357 6.548 6.740 6.929 7.121 7.312 7.503 7.693 8.077
	22530 FourSure® 44, Fully upholstered, Oak lacquered	5.7	-		1 2 3 4 5 6 7 8 10	6.447 6.668 6.889 7.110 7.329 7.552 7.772 7.993 8.476	

ACCESSORIES	Description	Weight (Kg)	Dimensions (mm)	Price (SEK)
	CHAIR FEET Felt glides, set of 4 pcs. height + 0,2 cm	1,82 g x 4		208
	CHAIR FEET Set of 4 pcs. Noise reducing ferrule with big diameter (reduces pressure marks) Chair height + 0,8 cm	4,8 g x 4		276
	CHAIR FEET Noise reducing ferrule with felt, set of 4 pcs. Chair height + 1 cm	6,6 g x 4		276
	CHAIR FEET Teflon glides, set of 4 pcs. Chair height + 0,2 cm	2,75 g x 4		208
	LINKING DEVICE Chair linking	0,4 KG	C/C 535 mm C/C with armrest 585 mm C/C with Loop armrest 625 mm	417
	GRIP HOLE Available for chairs without inside – and full upholstery			189
	INNO Inno® Note in black, removable and foldable. Not available for chairs with Loop armrest and chairs with wooden legs.	1,4 KG	225 x 325 x 10 mm	1.522
	SEAT ROW NUMBER - ACSR0101 16 mm - no. 1 -25	29 g		1.579
	SEAT ROW NUMBER - ACSR0102 16 mm - no. 26 -50	29 g		1.579
	INNO@NOTE TROLLEY - 20100007 Trolley for Inno® Note. Room for 51 Inno® Notes.	58,5 Kg	1532 x 662 x 1199 mm	19.942
	CHAIR TROLLEY - 200X0 28 chairs without upholstery	33,5 Kg	1100 x 560 x 1970 mm	8.859
	CHAIR TROLLEY - 200X0 20 chairs with seat pad / inside upholstery or 18 chairs with full upholstery	33,5 Kg	1100 x 560 x 1910 / 1980 mm	10.373
	SACK TROLLEY - 200X1 12 chairs without upholstery, 10 chairs with seat pad / inside upholstery or 6 chairs with full upholstery			4.918

SURCHARGE		Price (SEK)
FRAME OPTIONAL	 7 A D E F M N O Q S T	194
	 V	476



FEATURES

- Armrest options
- Linking device optional on frames or under seat
- Monochrome powder coating on frames options
- Polyamide glides as standard
- Inno® Note tablet options
- Stackable on matching trolley
- Outdoor options
- We do not recommend suspensions for fully upholstered version

For product information visit oceefour.com ↗

SHELL COLOURS

Standard Polypropylene



Optional Polypropylene

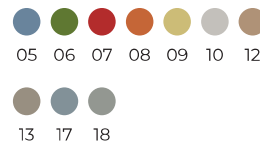

FRAME COLOURS

Standard









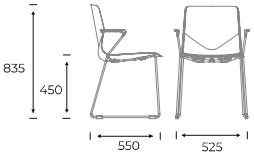

Frame optional*

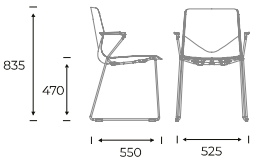

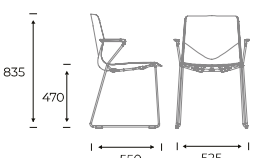
For full colour details [go to page 250](#) ↗

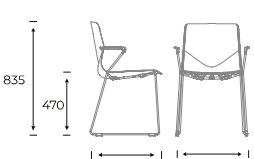
Product	Description (Item nr)	Weight (Kg)	Stacking on floor	Dimensions (mm)	Band	Standard PP (SEK)	Optional PP (SEK)
	23200 FourSure® 88, Polypropylene shell	6	12		-	2.479	2.670
	23210 FourSure® 88, Seat pad	6.8	10		1 2 3 4 5 6 7 8 10	3.741 3.836 3.931 4.025 4.117 4.213 4.308 4.402 4.620	3.932 4.027 4.122 4.216 4.308 4.404 4.499 4.593 4.811
	23220 FourSure® 88, Inside upholstered	7.2	10		1 2 3 4 5 6 7 8 10	4.897 5.088 5.280 5.469 5.661 5.852 6.043 6.233 6.617	5.088 5.279 5.471 5.660 5.852 6.043 6.234 6.424 6.808
	23230 FourSure® 88, Fully upholstered	6.6	8		1 2 3 4 5 6 7 8 10	5.178 5.399 5.620 5.841 6.060 6.283 6.503 6.724 7.207	

Product	Description (Item nr)	Weight (Kg)	Stacking on floor	Dimensions (mm)	Band	Standard PP (SEK)	Optional PP (SEK)
	23300 FourSure® 88 with Armrests, Polypropylene shell	6.7	12		-	3.609	3.800
	23310 FourSure® 88 with Armrests, Seat pad	7.5	10		1 2 3 4 5 6 7 8 10	4.871 4.966 5.061 5.155 5.247 5.343 5.438 5.532 5.750	5.062 5.157 5.252 5.346 5.438 5.534 5.629 5.723 5.941
	23320 FourSure® 88 with Armrests, Inside upholstery	7.9	10		1 2 3 4 5 6 7 8 10	6.027 6.218 6.410 6.599 6.791 6.982 7.173 7.363 7.747	6.218 6.409 6.601 6.790 6.982 7.173 7.364 7.554 7.938
	23330 FourSure® 88 with Armrests, Fully upholstered	7.4	8		1 2 3 4 5 6 7 8 10	6.308 6.529 6.750 6.971 7.190 7.413 7.633 7.854 8.337	

ACCESSORIES	Description	Weight (Kg)	Dimensions (mm)	Price (SEK)
	CHAIR FEET Felt glides, set of 4 pcs. height + 0,2 cm	1,82 g x 4		208
	CHAIR FEET Teflon glides, set of 4 pcs. Chair height + 0,2 cm	2,75 g x 4		208
	LINKING DEVICE Chair linking	0,4 KG	C/C 535 mm C/C with armrest 585 mm C/C with Loop armrest 625 mm	417
	LINKING DEVICE Chair linking		C/C 540 mm C/C with armrest 540 mm	390
	GRIP HOLE Available for chairs without inside – and full upholstery			189
	INNO Inno® Note in black, removable and foldable. Not available for chairs with Loop armrest and chairs with wooden legs.	1,4 KG	225 x 325 x 10 mm	1.522
	SEAT ROW NUMBER - ACSR0201 11 mm - no. 1 -25	29 g		1.579
	SEAT ROW NUMBER - ACSR0202 11 mm - no. 26 -50	29 g		1.579
	INNO@NOTE TROLLEY - 20100007 Trolley for Inno® Note. Room for 51 Inno® Notes.	58,5 Kg	1532 x 662 x 1199 mm	19.942
	CHAIR TROLLEY - 200X0 35 chairs without upholstery	33,5 Kg	1100 x 560 x 1970 mm	8.859
	CHAIR TROLLEY - 200X0 20 chairs with seat pad / inside upholstery or 18 chairs with full upholstery	33,5 Kg	1100 x 560 x 1910 / 1980 mm	10.373
	SACK TROLLEY - 200X1 12 chairs without upholstery, 10 with seat pad / inside upholstery or 8 chairs with full upholstery			4.918
SURCHARGE				Price (SEK)
FRAME OPTIONAL	 7 A D E F M N O Q S T			194

20% rabatt ska dras av på angivna priser



FEATURES

- Fits table height 90 cm
- Stackable on floor
- Polyamide glides as standard
- Monochrome powder coating on frames options
- Outdoor options
- We do not recommend suspensions to fully upholstered version



For product information visit oceefour.com ↗

SHELL COLOURS

Standard Polypropylene



FRAME COLOURS

Standard





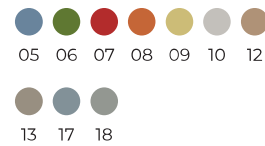



Optional Polypropylene

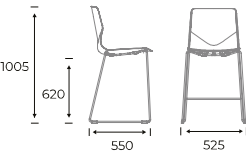

Frame optional*

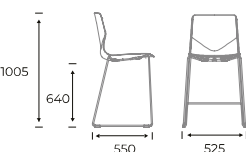

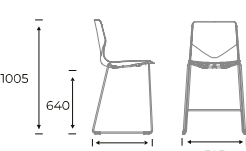

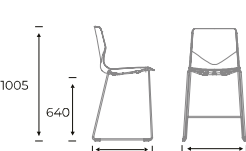



For full colour details [go to page 250](#) ↗

Product	Description (Item nr)	Weight (Kg)	Stacking on floor	Dimensions (mm)	Band	Standard PP (SEK)	Optional PP (SEK)
	23800 FourSure® 90, Polypropylene shell	6.9	4		-	3.409	3.600
	23810 FourSure® 90, Seat pad	7.8	4		1 2 3 4 5 6 7 8 10	4.671 4.766 4.861 4.955 5.047 5.143 5.238 5.332 5.550	4.862 4.957 5.052 5.146 5.238 5.334 5.429 5.523 5.741
	23820 FourSure® 90, Inside upholstery	8.1	4		1 2 3 4 5 6 7 8 10	5.827 6.018 6.210 6.399 6.591 6.782 6.973 7.163 7.547	6.018 6.209 6.401 6.590 6.782 6.973 7.164 7.354 7.738
	23830 FourSure® 90, Fully upholstered	7.6	4		1 2 3 4 5 6 7 8 10	6.108 6.329 6.550 6.771 6.990 7.213 7.433 7.654 8.137	

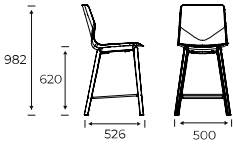
FourSure® 90

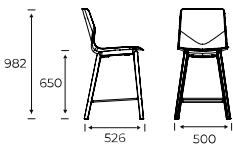
Design by Strand+Hvass

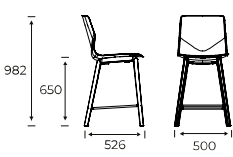
[Content ↗](#)

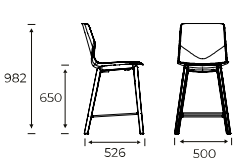
Product	Description (Item nr)	Weight (Kg)	Stacking on floor	Dimensions (mm)	Band	Standard PP (SEK)	Optional PP (SEK)
	23800 FourSure® 90, Polypropylene shell, Oak lacquered	6.9	-		-	5.170	5.361
	23810 FourSure® 90, Seat pad, Oak lacquered	7.8	-		1 2 3 4 5 6 7 8 10	6.432 6.527 6.622 6.716 6.808 6.904 6.999 7.093 7.311	6.623 6.718 6.813 6.907 6.999 7.095 7.190 7.284 7.502
	23820 FourSure® 90, Inside upholstery, Oak lacquered	8.1	-		1 2 3 4 5 6 7 8 10	7.588 7.779 7.971 8.160 8.352 8.543 8.734 8.924 9.308	7.779 7.970 8.162 8.351 8.543 8.734 8.925 9.115 9.499
	23830 FourSure® 90, Fully upholstered, Oak lacquered	7.6	-		1 2 3 4 5 6 7 8 10	7.869 8.090 8.311 8.532 8.751 8.974 9.194 9.415 9.898	

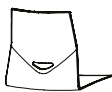
ACCESSORIES	Description	Weight (Kg)	Dimensions (mm)	Price (SEK)
	CHAIR FEET Felt glides, set of 4 pcs. height + 0,2 cm	1,82 g x 4		208
	CHAIR FEET Teflon glides, set of 4 pcs. Chair height + 0,2 cm	2,75 g x 4		208
	GRIP HOLE Available for chairs without inside- and full upholstery			189

SURCHARGE		Price (SEK)
FRAME OPTIONAL		194
	V	475

20% rabatt ska dras av på angivna priser

FourSure® 105

Design by Strand+Hvass

[Content ↗](#)



FEATURES

- Fits table height 105 cm
- Stackable on floor
- Polyamide glides as standard
- Monochrome powder coating on frames options
- Outdoor options
- We do not recommend suspensions to fully upholstered version



For product information visit oceefour.com ↗

SHELL COLOURS

Standard Polypropylene



FRAME COLOURS

Standard



Optional Polypropylene

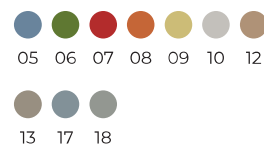

Frame optional*









For full colour details [go to page 250](#) ↗

Product	Description (Item nr)	Weight (Kg)	Stacking on floor	Dimensions (mm)	Band	Standard PP (SEK)	Optional PP (SEK)
	23900 FourSure® 105, Polypropylene shell	7.7	4		-	3.492	3.683
	23910 FourSure® 105, Seat pad	8.5	4		1 2 3 4 5 6 7 8 10	4.754 4.849 4.944 5.038 5.130 5.226 5.321 5.415 5.633	4.945 5.040 5.135 5.229 5.321 5.417 5.512 5.606 5.824
	23920 FourSure® 105, Inside upholstery	8.9	4		1 2 3 4 5 6 7 8 10	5.910 6.101 6.293 6.482 6.674 6.865 7.056 7.246 7.630	6.101 6.292 6.484 6.673 6.865 7.056 7.247 7.437 7.821
	23930 FourSure® 105, Fully upholstered	8.4	4		1 2 3 4 5 6 7 8 10	6.191 6.412 6.633 6.854 7.073 7.296 7.516 7.737 8.220	

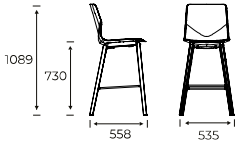
FourSure® 105

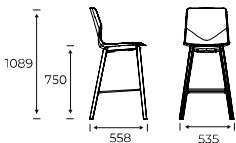
Design by Strand+Hvass

[Content ↗](#)

Product	Description (Item nr)	Weight (Kg)	Stacking on floor	Dimensions (mm)	Band	Standard PP (SEK)	Optional PP (SEK)
	23900 FourSure® 105, Polypropylene shell, Oak lacquered	7.7	-		-	5.366	5.557
	23910 FourSure® 105, Seat pad, Oak lacquered	8.5	-		1 2 3 4 5 6 7 8 10	6.628 6.723 6.818 6.912 7.004 7.100 7.195 7.289 7.507	6.819 6.914 7.009 7.103 7.195 7.291 7.386 7.480 7.698
	23920 FourSure® 105, Inside upholstery, Oak lacquered	8.9	-		1 2 3 4 5 6 7 8 10	7.784 7.975 8.167 8.356 8.548 8.739 8.930 9.120 9.504	7.975 8.166 8.358 8.547 8.739 8.930 9.121 9.311 9.695
	23930 FourSure® 105, Fully upholstered, Oak lacquered	8.4	-		1 2 3 4 5 6 7 8 10	8.065 8.286 8.507 8.728 8.947 9.170 9.390 9.611 10.094	

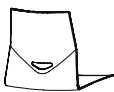
ACCESSORIES	Description	Weight (Kg)	Dimensions (mm)	Price (SEK)
	CHAIR FEET Felt glides, set of 4 pcs. height + 0,2 cm	1,82 g x 4		208
	CHAIR FEET Teflon glides, set of 4 pcs. Chair height + 0,2 cm	2,75 g x 4		208
	GRIP HOLE Available for chairs without inside – and full upholstery			189

SURCHARGE		Price (SEK)
FRAME OPTIONAL	 7 A D E F M N O Q S T  V	194 474

20% rabatt ska dras av på angivna priser



FEATURES

- Inno® Tab, flexible and rotating writing tablet options
- Gas lift, 41 - 57,5 cm
- Free Float options
- Black base with castors as standard
- Aluminium base options
- We do not recommend suspensions to fully upholstered version



For product information visit oceefour.com ↗

SHELL COLOURS

Standard Polypropylene



FRAME COLOURS

Standard





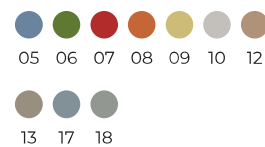

Optional Polypropylene





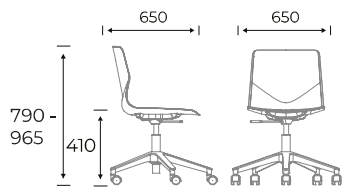

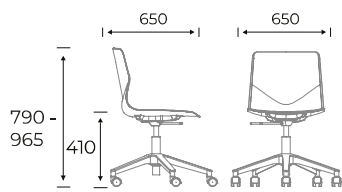

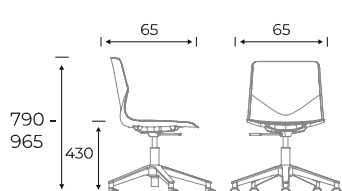

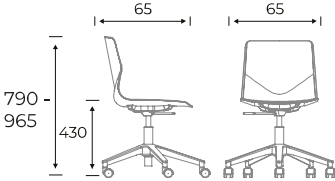

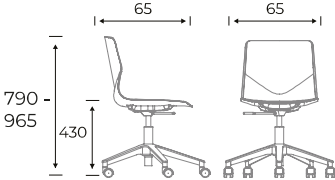

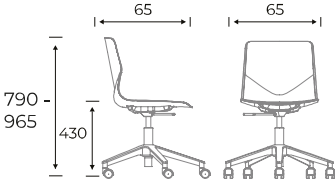

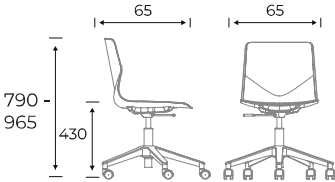

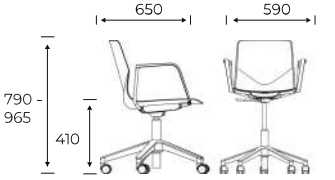

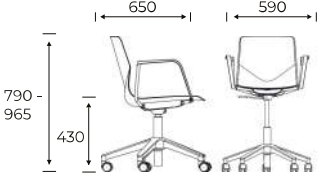

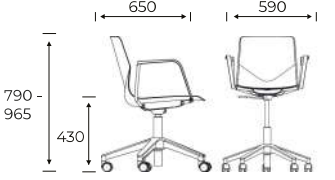
Frame optional*

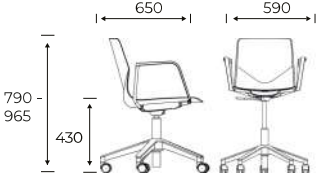

For full colour details [go to page 250](#) ↗

Product	Description (Item nr)	Weight (Kg)	Dimensions (mm)	Band	Standard PP (SEK)	Optional PP (SEK)
	25004 FourSure® 66, Polypropylene shell, Without tilt with gas	7.4		-	2.783	2.974
	25005 FourSure® 66, Polypropylene shell, With tilt with gas	7.5		-	3.147	3.338
	25014 FourSure® 66, Seat pad, Without tilt with gas	8		1 2 3 4 5 6 7 8 10	4.045 4.140 4.235 4.329 4.421 4.517 4.612 4.706 4.924	4.236 4.331 4.426 4.520 4.612 4.708 4.803 4.897 5.115
	25015 FourSure® 66, Seat pad, With tilt with gas	8		1 2 3 4 5 6 7 8 10	4.409 4.504 4.599 4.693 4.785 4.881 4.976 5.070 5.288	4.600 4.695 4.790 4.884 4.976 5.072 5.167 5.261 5.479

Product	Description (Item nr)	Weight (Kg)	Dimensions (mm)	Band	Standard PP (SEK)	Optional PP (SEK)
	25024 FourSure® 66, Inside upholstery, Without tilt with gas	8.4		1 2 3 4 5 6 7 8 10	5.201 5.392 5.584 5.773 5.965 6.156 6.347 6.537 6.921	5.392 5.583 5.775 5.964 6.156 6.347 6.538 6.728 7.112
	25025 FourSure® 66, Inside upholstery, With tilt with gas	8.4		1 2 3 4 5 6 7 8 10	5.565 5.756 5.948 6.137 6.329 6.520 6.711 6.901 7.285	5.756 5.947 6.139 6.328 6.520 6.711 7.092 7.476
	25034 FourSure® 66, Fully upholstered, Without tilt with gas	7.8		1 2 3 4 5 6 7 8 10	5.482 5.703 5.924 6.145 6.364 6.587 6.807 7.028 7.511	
	25035 FourSure® 66, Fully upholstered, With tilt with gas	13.7		1 2 3 4 5 6 7 8 10	5.846 6.067 6.288 6.509 6.728 6.951 7.171 7.392 7.875	
	24905 FourSure® 66 with Loop Armrests, Polypropylene shell, With tilt with gas	8.7		-	4.291	4.482
	24915 FourSure® 66 with Loop Armrests, Seat pad, With tilt with gas	9.4		1 2 3 4 5 6 7 8 10	5.553 5.648 5.743 5.837 5.929 6.025 6.120 6.214 6.432	5.744 5.839 5.934 6.028 6.120 6.216 6.311 6.405 6.623
	24925 FourSure® 66 with Loop Armrests, Inside upholstery, With tilt with gas	9.7		1 2 3 4 5 6 7 8 10	6.709 6.900 7.092 7.281 7.473 7.664 7.855 8.045 8.429	6.900 7.091 7.283 7.472 7.664 7.855 8.046 8.236 8.620
	24935 FourSure® 66 with Loop Armrests, Fully upholstered, With tilt with gas	9.2		1 2 3 4 5 6 7 8 10	6.990 7.211 7.432 7.653 7.872 8.095 8.315 8.536 9.019	

ACCESSORIES	Description	Weight (Kg)	Dimensions (mm)	Price (SEK)
	HOOK Hook in black			47
	CHAIR FEET Standard polymide glides. Chair height + 0,2 cm			
	CHAIR FEET Castor with breaks, hard			599
	FOOTRING Gas lift including footring Spand 41 cm. - 57,5 cm.		585 - 845 mm	1.368
	With GS certification			1.489
	INNO Foldable Inno® Tab in black with integrated cup holder and dashboard for tablet and phone.	2,7 KG	520 x 320 x 23 mm	2.125
SURCHARGE				Price (SEK)
FRAME OPTIONAL	 4			643



FEATURES

- Armrest options
- Stackable on floor
- Monochrome powder coating on frames options
- We do not recommend suspensions for fully upholstered version

For product information visit oceefour.com ↗

SHELL COLOURS

Standard Polypropylene



Optional Polypropylene



FRAME COLOURS







Standard

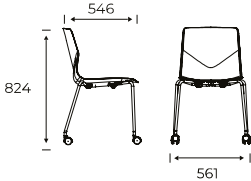

Frame optional*

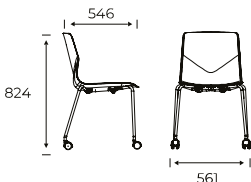

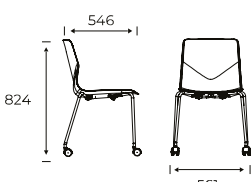

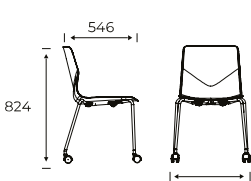



For full colour details [go to page 250](#) ↗

Product	Description (Item nr)	Weight (Kg)	Stacking on floor	Dimensions (mm)	Band	Standard PP (SEK)	Optional PP (SEK)
	22800 FourSure® 77, Polypropylene shell	6	7		-	2.464	2.655
	22810 FourSure® 77, Seat pad	6.9	5		1 2 3 4 5 6 7 8 10	3.726 3.821 3.916 4.010 4.102 4.198 4.293 4.387 4.605	3.917 4.012 4.107 4.201 4.293 4.389 4.484 4.578 4.796
	22820 FourSure® 77, Inside upholstery	7.3	5		1 2 3 4 5 6 7 8 10	4.882 5.073 5.265 5.454 5.646 5.837 6.028 6.218 6.602	5.073 5.264 5.456 5.645 5.837 6.028 6.219 6.409 6.793
	22830 FourSure® 77, Fully upholstered	6.8	5		1 2 3 4 5 6 7 8 10	5.163 5.384 5.605 5.826 6.045 6.268 6.488 6.709 7.192	

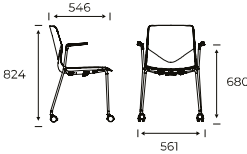
FourSure® 77

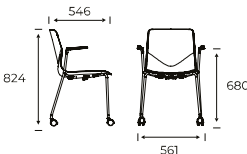
Design by Strand+Hvass

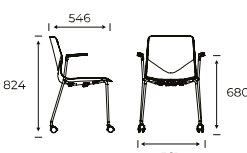
[Content ↗](#)

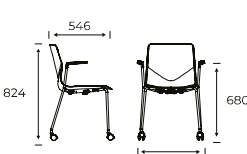
Product	Description (Item nr)	Weight (Kg)	Stacking on floor	Dimensions (mm)	Band	Standard PP (SEK)	Optional PP (SEK)
	22900 FourSure® 77 with Armrests, Polypropylene shell	7.5	-		-	3.618	3.809
	22910 FourSure® 77 with Armrests, Seat pad	8	-		1 2 3 4 5 6 7 8 10	4.880 4.975 5.070 5.164 5.256 5.352 5.447 5.541 5.759	5.071 5.166 5.261 5.355 5.447 5.543 5.638 5.732 5.950
	22920 FourSure® 77 with Armrests, Inside upholstery	8.4	-		1 2 3 4 5 6 7 8 10	6.036 6.227 6.419 6.608 6.800 6.991 7.182 7.372 7.756	6.227 6.418 6.610 6.799 6.991 7.182 7.373 7.563 7.947
	22930 FourSure® 77 with Armrests, Fully upholstered	8.2	-		1 2 3 4 5 6 7 8 10	6.317 6.538 6.759 6.980 7.199 7.422 7.642 7.863 8.346	

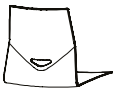
ACCESSORIES	Description	Weight (Kg)	Dimensions (mm)	Price (SEK)
	GRIP HOLE Available for chairs without inside – and full upholstery			189

SURCHARGE		Price (SEK)
FRAME OPTIONAL	 7 A D E F M N O Q S T	194



FEATURES

- Armrest options
- Swivel with freefloat in seat/back
- Return mechanism options
- Polyamide glides as standard
- Teflon or felt glides and soft castor options
- Soft castor options (fixed cone without swivel and return)
- We do not recommend suspensions to fully upholstered version

For product information visit oceefour.com ↗

SHELL COLOURS

Standard Polypropylene



FRAME COLOURS





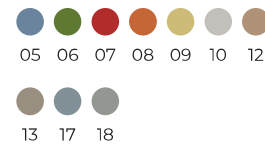

Standard



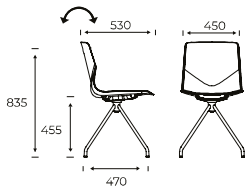

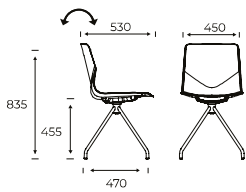

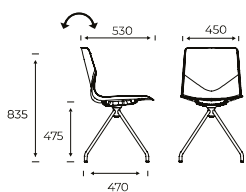

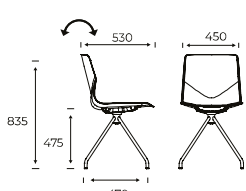

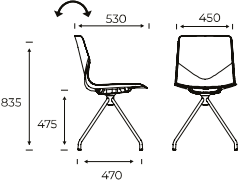

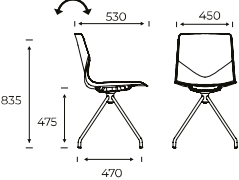

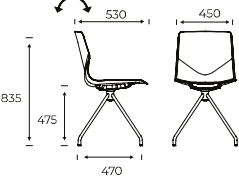

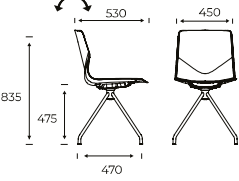

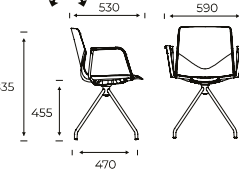

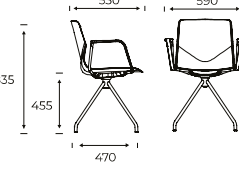

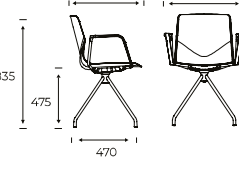

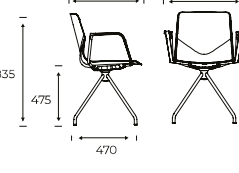
Optional Polypropylene



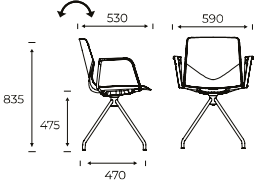

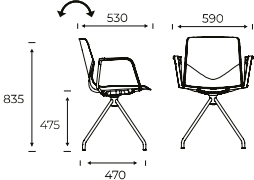
For full colour details [go to page 250](#) ↗

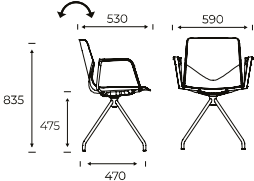
Product	Description (Item nr)	Weight (Kg)	Dimensions (mm)	Band	Standard PP (SEK)	Optional PP (SEK)
	23001 FourSure® 11, Polypropylene shell, With tilt	6.7		-	3.627	3.818
	23003 FourSure® 11, Polypropylene shell, With tilt with return	6.6		-	4.800	4.991
	23011 FourSure® 11, Seat pad, With tilt	7.1		1 2 3 4 5 6 7 8 10	4.889 4.984 5.079 5.173 5.265 5.361 5.456 5.550 5.768	5.080 5.175 5.270 5.364 5.456 5.552 5.647 5.741 5.959
	23013 FourSure® 11, Seat pad, With tilt with return	7.1		1 2 3 4 5 6 7 8 10	6.062 6.157 6.252 6.346 6.438 6.534 6.629 6.723 6.941	6.253 6.348 6.443 6.537 6.629 6.725 6.820 6.914 7.132

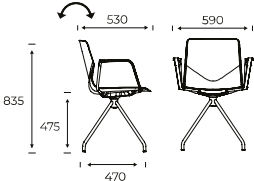
Product	Description (Item nr)	Weight (Kg)	Dimensions (mm)	Band	Standard PP (SEK)	Optional PP (SEK)
	23021 FourSure® 11, Inside upholstery, With tilt	7.5		1 2 3 4 5 6 7 8 10	6.045 6.236 6.428 6.617 6.809 7.000 7.191 7.381 7.765	6.236 6.427 6.619 6.808 7.000 7.191 7.382 7.572 7.956
	23023 FourSure® 11, Inside upholstery, With tilt with return	7.4		1 2 3 4 5 6 7 8 10	7.218 7.409 7.601 7.790 7.982 8.173 8.364 8.554 8.938	7.409 7.600 7.792 7.981 8.173 8.364 8.555 8.745 9.129
	23031 FourSure® 11, Fully upholstered, With tilt	7		1 2 3 4 5 6 7 8 10	6.326 6.547 6.768 6.989 7.208 7.431 7.651 7.872 8.355	
	23033 FourSure® 11, Fully upholstered, With tilt with return	6.9		1 2 3 4 5 6 7 8 10	7.499 7.720 7.941 8.162 8.381 8.604 8.824 9.045 9.528	
	23101 FourSure® 11 with Loop Armrests, Polypropylene shell, With tilt	7.8		-	4.780	4.971
	23103 FourSure® 11 with Loop Armrests, Polypropylene shell, With tilt with return	7.7		-	5.953	6.144
	23111 FourSure® 11 with Loop Armrests, Seat pad, With tilt	8.3		1 2 3 4 5 6 7 8 10	6.042 6.137 6.232 6.326 6.418 6.514 6.609 6.703 6.921	6.233 6.328 6.423 6.517 6.609 6.705 6.800 6.894 7.112
	23113 FourSure® 11 with Loop Armrests, Seat pad, With tilt with return	8.2		1 2 3 4 5 6 7 8 10	7.215 7.310 7.405 7.499 7.591 7.687 7.782 7.876 8.094	7.406 7.501 7.596 7.690 7.782 7.878 7.973 8.067 8.285

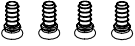
Product	Description (Item nr)	Weight (Kg)	Dimensions (mm)	Band	Standard PP (SEK)	Optional PP (SEK)
	23121 FourSure® 11 with Loop Armrests, Inside upholstery, With tilt	8.7		1 2 3 4 5 6 7 8 10	7.198 7.389 7.581 7.770 7.962 8.153 8.344 8.534 8.918	7.389 7.580 7.772 7.961 8.153 8.344 8.535 8.725 9.109
	23123 FourSure® 11 with Loop Armrests, Inside upholstery, With tilt with return	8.6		1 2 3 4 5 6 7 8 10	8.371 8.562 8.754 8.943 9.135 9.326 9.517 9.707 10.091	8.562 8.753 8.945 9.134 9.326 9.517 9.708 9.898 10.282
	23131 FourSure® 11 with Loop Armrests, Fully upholstered, With tilt	7.9		1 2 3 4 5 6 7 8 10	7.479 7.700 7.921 8.142 8.361 8.584 8.804 9.025 9.508	
	23133 FourSure® 11 with Loop Armrests, Fully upholstered, With tilt with return	8.1		1 2 3 4 5 6 7 8 10	8.652 8.873 9.094 9.315 9.534 9.757 9.977 10.198 10.681	

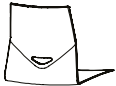
ACCESSORIES	Description	Weight (Kg)	Dimensions (mm)	Price (SEK)
	CHAIR FEET Castors			876
	CHAIR FEET Felt glides, set of 4 pcs. height + 0,2 cm	1,82 g x 4		208
	CHAIR FEET Set of 4 pcs. Noise reducing ferrule with big diameter (reduces pressure marks) Chair height + 0,8 cm	4,8 g x 4		276
	CHAIR FEET Noise reducing ferrule with felt, set of 4 pcs. Chair height + 1 cm	6,6 g x 4		276
	CHAIR FEET Teflon glides, set of 4 pcs. Chair height + 0,2 cm	2,75 g x 4		208
	GRIP HOLE Available for chairs without inside – and full upholstery			189



FEATURES

- Swivel frame with free float seat/back as standard
- Return mechanism options
- Loop Armchair options
- Polyamide glides as standard
- Teflon or felt glides and soft castor options
- Powder coated frame options
- We do not recommend suspensions to fully upholstered version



For product information visit oceefour.com ↗

SHELL COLOURS

Standard Polypropylene



FRAME COLOURS

Standard



Optional Polypropylene

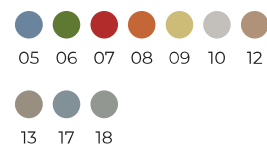









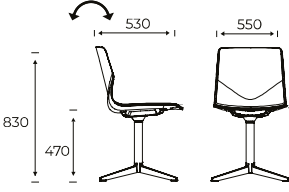

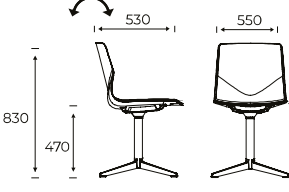

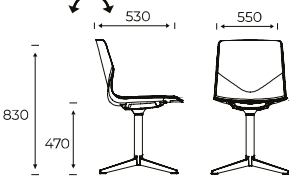

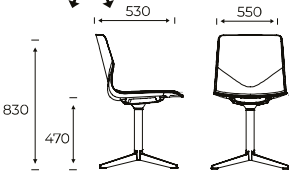

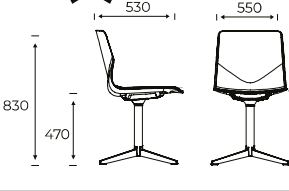

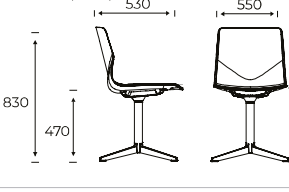

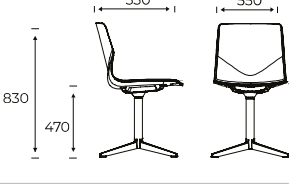

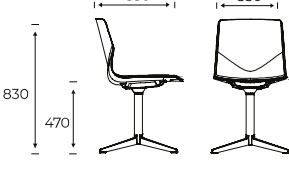



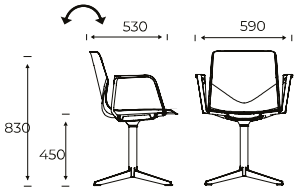

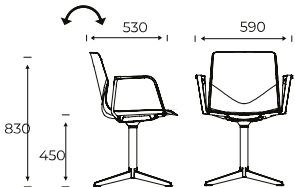

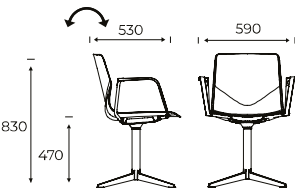
Frame optional*

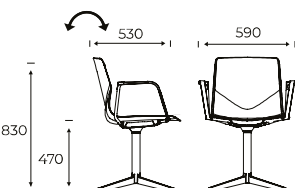

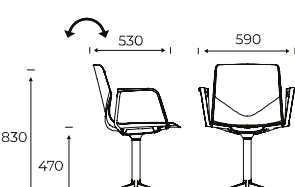

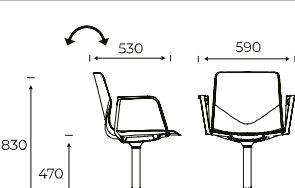

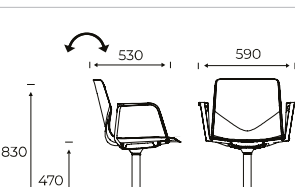

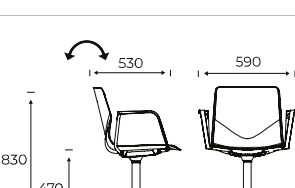
For full colour details [go to page 250](#) ↗

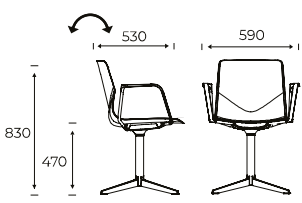
Product	Description (Item nr)	Weight (Kg)	Dimensions (mm)	Band	Standard PP (SEK)	Optional PP (SEK)
	24001 FourSure® 99, Polypropylene shell, With tilt	7.2		-	4.767	4.958
	24003 FourSure® 99, Polypropylene shell, With tilt with return	7.2		-	5.267	5.458
	24005 FourSure® 99, Polypropylene shell, With tilt with gas	7.7		-	5.267	5.458
	24011 FourSure® 99, Seat pad. With tilt	7.7		1 2 3 4 5 6 7 8 10	6.029 6.124 6.219 6.313 6.405 6.501 6.596 6.690 6.908	6.220 6.315 6.410 6.504 6.596 6.692 6.787 6.881 7.099

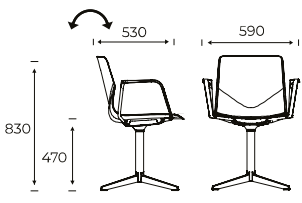
Product	Description (Item nr)	Weight (Kg)	Dimensions (mm)	Band	Standard PP (SEK)	Optional PP (SEK)
	24013 FourSure® 99, Seat pad, With tilt with return	7.7		1 2 3 4 5 6 7 8 10	6.529 6.624 6.719 6.813 6.905 7.001 7.096 7.190 7.408	6.720 6.815 6.910 7.004 7.096 7.192 7.287 7.381 7.599
	24015 FourSure® 99, Seat pad, With tilt with gas	8.6		1 2 3 4 5 6 7 8 10	6.529 6.624 6.719 6.813 6.905 7.001 7.096 7.190 7.408	6.720 6.815 6.910 7.004 7.096 7.192 7.287 7.381 7.599
	24021 FourSure® 99, Inside upholstery, With tilt	8.1		1 2 3 4 5 6 7 8 10	7.185 7.376 7.568 7.757 7.949 8.140 8.331 8.521 8.905	7.376 7.567 7.759 7.948 8.140 8.331 8.522 8.712 9.096
	24023 FourSure® 99, Inside upholstery, With tilt with return	8.1		1 2 3 4 5 6 7 8 10	7.685 7.876 8.068 8.257 8.449 8.640 8.831 9.021 9.405	7.876 8.067 8.259 8.448 8.640 8.831 9.022 9.212 9.596
	24025 FourSure® 99, Inside upholstery, With tilt with gas	9		1 2 3 4 5 6 7 8 10	7.685 7.876 8.068 8.257 8.449 8.640 8.831 9.021 9.405	7.876 8.067 8.259 8.448 8.640 8.831 9.022 9.212 9.596
	24031 FourSure® 99, Fully upholstered, With tilt	7.5		1 2 3 4 5 6 7 8 10	7.466 7.687 7.908 8.129 8.348 8.571 8.791 9.012 9.495	
	24033 FourSure® 99, Fully upholstered, With tilt with return	7.5		1 2 3 4 5 6 7 8 10	7.966 8.187 8.408 8.629 8.848 9.071 9.291 9.512 9.995	
	24035 FourSure® 99, Fully upholstered, With tilt with gas	-		1 2 3 4 5 6 7 8 10	7.966 8.187 8.408 8.629 8.848 9.071 9.291 9.512 9.995	

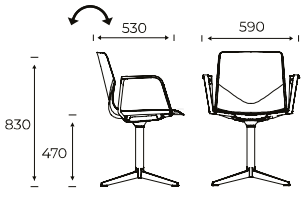
Product	Description (Item nr)	Weight (Kg)	Dimensions (mm)	Band	Standard PP (SEK)	Optional PP (SEK)
	24101 FourSure® 99 with Loop Armrests, Polypropylene shell, With tilt	8.5		-	5.918	6.109
	24103 FourSure® 99 with Loop Armrests, Polypropylene shell, With tilt with return	8.5		-	6.418	6.609
	24105 FourSure® 99 with Loop Armrests, Polypropylene shell, With tilt with gas	9.5		-	6.418	6.609
	24111 FourSure® 99 with Loop Armrests, Seat pad, With tilt	9.1		1 2 3 4 5 6 7 8 10	7.180 7.275 7.370 7.464 7.556 7.652 7.747 7.841 8.059	7.371 7.466 7.561 7.655 7.747 7.843 7.938 8.032 8.250
	24113 FourSure® 99 with Loop Armrests, Seat pad, With tilt with return	9		1 2 3 4 5 6 7 8 10	7.680 7.775 7.870 7.964 8.056 8.152 8.247 8.341 8.559	7.871 7.966 8.061 8.155 8.247 8.343 8.438 8.532 8.750
	24115 FourSure® 99 with Loop Armrests, Seat pad, With tilt with gas	10		1 2 3 4 5 6 7 8 10	7.680 7.775 7.870 7.964 8.056 8.152 8.247 8.341 8.559	7.871 7.966 8.061 8.155 8.247 8.343 8.438 8.532 8.750
	24121 FourSure® 99 with Loop Armrests, Inside upholstery, With tilt	9.4		1 2 3 4 5 6 7 8 10	8.336 8.527 8.719 8.908 9.100 9.291 9.482 9.672 10.056	8.527 8.718 8.910 9.099 9.291 9.482 9.673 9.863 10.247
	24123 FourSure® 99 with Loop Armrests, Inside upholstery, With tilt with return	9.4		1 2 3 4 5 6 7 8 10	8.836 9.027 9.219 9.408 9.600 9.791 9.982 10.172 10.556	9.027 9.218 9.410 9.599 9.791 9.982 10.173 10.363 10.747

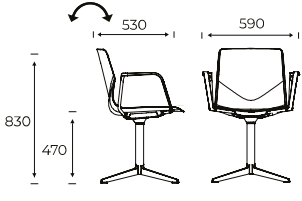
Product	Description (Item nr)	Weight (Kg)	Dimensions (mm)	Band	Standard PP (SEK)	Optional PP (SEK)
	24125 FourSure® 99 with Loop Armrests, Inside upholstery, With tilt with gas	10.4		1 2 3 4 5 6 7 8 10	8.836 9.027 9.219 9.408 9.600 9.791 9.982 10.172 10.556	9.027 9.218 9.410 9.599 9.791 9.982 10.173 10.363 10.747
	24131 FourSure® 99 with Loop Armrests, Fully upholstered, With tilt	8.8		1 2 3 4 5 6 7 8 10	8.617 8.838 9.059 9.280 9.499 9.722 9.942 10.163 10.646	
	24133 FourSure® 99 with Loop Armrests, Fully upholstered, With tilt with return	8.8		1 2 3 4 5 6 7 8 10	9.117 9.338 9.559 9.780 9.999 10.222 10.442 10.663 11.146	
	24135 FourSure® 99 with Loop Armrests, Fully upholstered, With tilt with gas	8.5		1 2 3 4 5 6 7 8 10	9.117 9.338 9.559 9.780 9.999 10.222 10.442 10.663 11.146	

ACCESSORIES	Description	Weight (Kg)	Dimensions (mm)	Price (SEK)
	CHAIR FEET Castors			1.154
	CHAIR FEET Felt glides, set of 4 pcs. height + 0,2 cm	1,82 g x 4		208

SURCHARGE		Price (SEK)
FRAME OPTIONAL	 B C K	1058

EU Ecolabel FourCast® 2

Design by Strand+Hvass

[Content ↗](#)



FEATURES

- The chair consists of 50 % recycled plastic
- Limitation of substances that are harmful to health and the environment
- Linking device optional on frames or under seat
- Matches table height 74 cm, 90 cm & 105 cm
- Polyamide glides as standard
- Stackable on matching trolley



For product information visit oceefour.com ↗

SHELL COLOURS

Standard Polypropylene







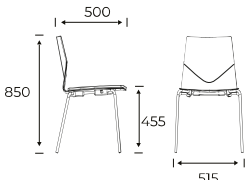

FRAME COLOURS

Standard

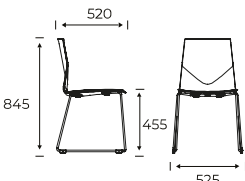

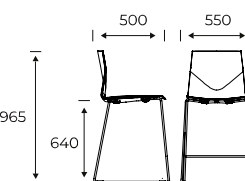

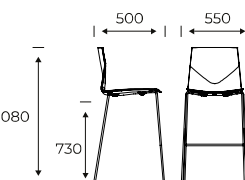
For full colour details [go to page 236](#) ↗







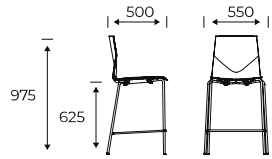

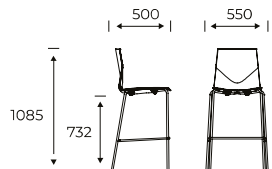
Product	Description (Item nr)	Weight (Kg)	Stacking on floor	Dimensions (mm)	Band	Standard PP (SEK)
	32500 FourCast® 2 Four, Polypropylene shell	4.8	-		-	2.290
	33200 FourCast® 2 Line, Polypropylene shell	5.7	-		-	2.776
	33800 FourCast® 2 Counter, Polypropylene shell	6.6	-		-	3.730
	33900 FourCast® 2 High, Polypropylene shell	7.3	-		-	3.815

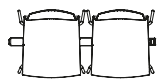
EU Ecolabel FourCast® 2

[Content ↗](#)

Design by Strand+Hvass

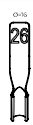
Product	Description (Item nr)	Weight (Kg)	Stacking on floor	Dimensions (mm)	Band	Standard PP (SEK)
	34000 FourCast@ 2 Counter Four, Polypropylene shell	7.7	-		-	3.492
	34100 FourCast@ 2 High Four, Polypropylene shell	6.7	-		-	3.492

ACCESSORIES	Description	Weight (Kg)	Dimensions (mm)	Price (SEK)
	CHAIR FEET Felt glides, set of 4 pcs. height + 0,2 cm	1,82 g x 4		208
	CHAIR FEET Teflon glides, set of 4 pcs. Chair height + 0,2 cm	2,75 g x 4		208
	LINKING DEVICE Chair linking	0,4 KG	C/C 535 mm C/C with armrest 585 mm C/C with Loop armrest 625 mm	417
	LINKING DEVICE Chair linking		C/C 540 mm C/C with armrest 540 mm	390
	GRIP HOLE Available for chairs without inside – and full upholstery			189
	SEAT ROW NUMBER - ACSR0201 11 mm - no. 1 -25	29 g		1.579
	SEAT ROW NUMBER - ACSR0202 11 mm - no. 26 -50	29 g		1.579
	SEAT ROW NUMBER - ACSR0101 16 mm - no. 1 -25	29 g		1.579
	SEAT ROW NUMBER - ACSR0102 16 mm - no. 26 -50	29 g		1.579
	CHAIR TROLLEY - 200X0 25 chairs without upholstery	33,5 Kg	1100 x 560 x 1970 mm	8.859

20% rabatt ska dras av på angivna priser

FourCast® 2 Four

Design by Strand+Hvass

[Content](#) ↗



FEATURES

- Armrest options and wooden legs options*
- Linking device under seat options
- Monochrome powder coating on frames options
- Polyamide glides as standard
- Inno® Note tablet options
- Stackable on matching trolley
- We do not recommend suspensions for fully upholstered versions



For product information visit oceefour.com ↗

SHELL COLOURS

Standard Polypropylene



FRAME COLOURS

Standard





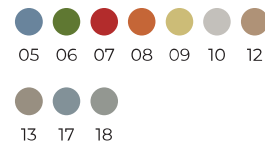



Optional Polypropylene

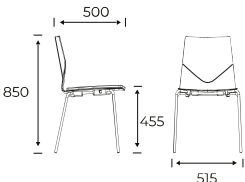

Frame optional*

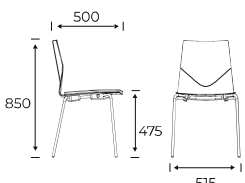

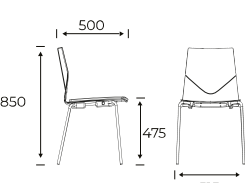

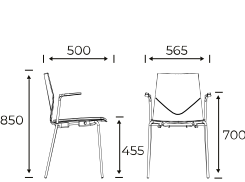



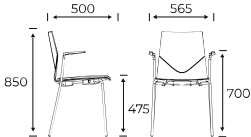

For full colour details [go to page 236](#) ↗

Product	Description (Item nr)	Weight (Kg)	Stacking on floor	Dimensions (mm)	Band	Standard PP (SEK)	Optional PP (SEK)
	32500 FourCast® 2 Four, Polypropylene shell	4.8	12		-	2.290	2.481
	32510 FourCast® 2 Four, Seat pad	5.8	10		1 2 3 4 5 6 7 8 10	3.552 3.647 3.742 3.836 3.928 4.024 4.119 4.213 4.431	3.743 3.838 3.933 4.027 4.119 4.215 4.310 4.404 4.622
	32530 FourCast® 2 Four, Fully upholstered	4.1	6		1 2 3 4 5 6 7 8 10	4.999 5.220 5.443 5.663 5.882 6.103 6.325 6.544 7.030	
	32600 FourCast® 2 Four with Armrests, Polypropylene shell	5.3	12		-	3.443	3.634

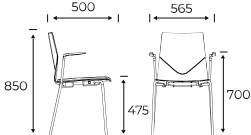
FourCast® 2 Four

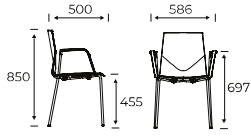
Design by Strand+Hvass

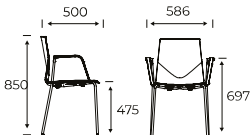
[Content ↗](#)

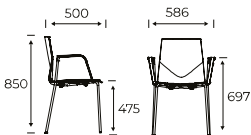







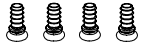

Product	Description (Item nr)	Weight (Kg)	Stacking on floor	Dimensions (mm)	Band	Standard PP (SEK)	Optional PP (SEK)
	32610 FourCast® 2 Four with Armrests, Seat pad	6.3	10		1 2 3 4 5 6 7 8 10	4.705 4.800 4.895 4.989 5.081 5.177 5.272 5.366 5.584	4.896 4.991 5.086 5.180 5.272 5.368 5.463 5.557 5.775
	32630 FourCast® 2 Four with Armrests, Fully upholstered	4.6	6		1 2 3 4 5 6 7 8 10	6.152 6.373 6.596 6.816 7.035 7.256 7.478 7.697 8.183	
	32700 FourCast® 2 Four with Loop Armrests, Polypropylene shell	5.9	12		-	3.443	3.634
	32710 FourCast® 2 Four with Loop Armrests, Seat pad	6.8	10		1 2 3 4 5 6 7 8 10	4.705 4.800 4.895 4.989 5.081 5.177 5.272 5.366 5.584	4.896 4.991 5.086 5.180 5.272 5.368 5.463 5.557 5.775
	32730 FourCast® 2 Four with Loop Armrests, Fully upholstered	5.2	6		1 2 3 4 5 6 7 8 10	6.152 6.373 6.596 6.816 7.035 7.256 7.478 7.697 8.183	

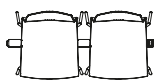
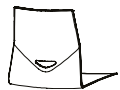
20% rabatt ska dras av på angivna priser

FourCast® 2 Four

Design by Strand+Hvass

[Content ↗](#)

ACCESSORIES	Description	Weight (Kg)	Dimensions (mm)	Price (SEK)
	CHAIR FEET Felt glides, set of 4 pcs. height + 0,2 cm	1,82 g x 4		208
	CHAIR FEET Set of 4 pcs. Noise reducing ferrule with big diameter (reduces pressure marks) Chair height + 0,8 cm	4,8 g x 4		276
	CHAIR FEET Noise reducing ferrule with felt, set of 4 pcs. Chair height + 1 cm	6,6 g x 4		276
	CHAIR FEET Teflon glides, set of 4 pcs. Chair height + 0,2 cm	2,75 g x 4		208
	LINKING DEVICE Chair linking	0,4 KG	C/C 535 mm C/C with armrest 585 mm C/C with Loop armrest 625 mm	417
	GRIP HOLE Available for chairs without inside – and full upholstery			189
	INNO Inno® Note in black, removable and foldable. Not available for chairs with Loop armrest and chairs with wooden legs.	1,4 KG	225 x 325 x 10 mm	1.522
	SEAT ROW NUMBER - ACSR0101 16 mm - no. 1-25	29 g		1.579
	SEAT ROW NUMBER - ACSR0102 16 mm - no. 26-50	29 g		1.579
	INNO@NOTE TROLLEY - 20100007 Trolley for Inno® Note. Room for 51 Inno® Notes.	58,5 Kg	1532 x 662 x 1199 mm	19.942
	CHAIR TROLLEY - 200X0 25 chairs without upholstery	33,5 Kg	1100 x 560 x 1970 mm	8.859
	CHAIR TROLLEY - 200X0 20 chairs with seat pad or 18 chairs with full upholstery	33,5 Kg	1100 x 560 x 1910 / 1980 mm	10.373
	SACK TROLLEY - 200X1 12 chairs without upholstery, 10 chairs with full upholstery			4.918

FourCast® 2 Four

Design by Strand+Hvass

[Content ↗](#)

SURCHARGE		Price (SEK)
FRAME OPTIONAL	 7 A D E F M N O Q S T	194

20% rabatt ska dras av på angivna priser

FourCast® 2 Four - Veneer

Design by Strand+Hvass

[Content](#) ↗



FEATURES

- Armrest options and wooden legs options*
- Linking device under seat options
- Monochrome powder coating on frames options
- Polyamide glides as standard
- Inno® Note tablet options
- Stackable on matching trolley
- We do not recommend suspensions to black lacquered versions



For product information visit oceefour.com ↗

SHELL COLOURS

Veneer



FRAME COLOURS







Standard

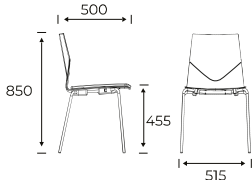

Frame optional*

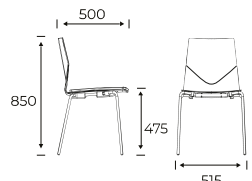

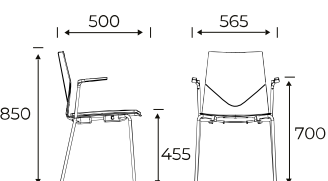

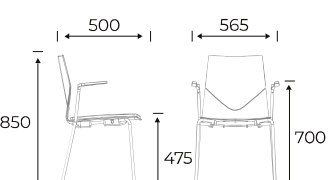
For full colour details [go to page 236](#) ↗

Product	Description (Item nr)	Weight (Kg)	Stacking on floor	Dimensions (mm)	Band	Veneer (SEK)
	32540 FourCast® 2 Four, Wooden shell	3.3	12		-	3.212
	32550 FourCast® 2 Four, Seat pad, wooden shell	4.8	10		1 2 3 4 5 6 7 8 10	4.474 4.569 4.664 4.758 4.850 4.946 5.041 5.135 5.353
	32640 FourCast® 2 Four with Armrests, Wooden shell	3.9	6		-	4.365
	32650 FourCast® 2 Four with Armrests, Seat pad, wooden shell	5.3	12		1 2 3 4 5 6 7 8 10	5.627 5.722 5.817 5.911 6.003 6.099 6.194 6.288 6.506

FourCast® 2 Four - Veneer

[Content ↗](#)

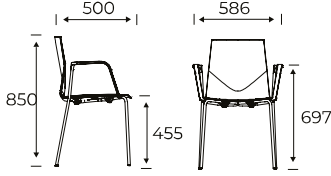
Design by Strand+Hvass

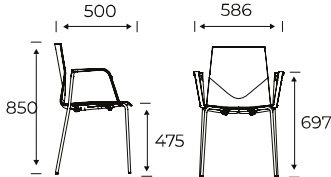







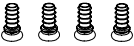

Product	Description (Item nr)	Weight (Kg)	Stacking on floor	Dimensions (mm)	Band	Veneer (SEK)
	32740 FourCast® 2 Four with Loop Armrests, Wooden shell	4.4	10		-	4.365
	32750 FourCast® 2 Four with Loop Armrests, Seat pad, wooden shell	5.8	6		1 2 3 4 5 6 7 8 10	5.627 5.722 5.817 5.911 6.003 6.099 6.194 6.288 6.506

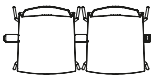
20% rabatt ska dras av på angivna priser

FourCast® 2 Four - Veneer

Design by Strand+Hvass

[Content ↗](#)

ACCESSORIES	Description	Weight (Kg)	Dimensions (mm)	Price (SEK)
	CHAIR FEET Felt glides, set of 4 pcs. height + 0,2 cm	1,82 g x 4		208
	CHAIR FEET Set of 4 pcs. Noise reducing ferrule with big diameter (reduces pressure marks) Chair height + 0,8 cm	4,8 g x 4		276
	CHAIR FEET Noise reducing ferrule with felt, set of 4 pcs. Chair height + 1 cm	6,6 g x 4		276
	CHAIR FEET Teflon glides, set of 4 pcs. Chair height + 0,2 cm	2,75 g x 4		208
	LINKING DEVICE Chair linking	0,4 KG	C/C 535 mm C/C with armrest 585 mm C/C with Loop armrest 625 mm	417
	GRIP HOLE Available for chairs without inside – and full upholstery			189
	INNO Inno® Note in black, removable and foldable. Not available for chairs with Loop armrest and chairs with wooden legs.	1,4 KG	225 x 325 x 10 mm	1.522
	SEAT ROW NUMBER - ACSR0101 16 mm - no. 1-25	29 g		1.579
	SEAT ROW NUMBER - ACSR0102 16 mm - no. 26-50	29 g		1.579
	INNO@NOTE TROLLEY - 20100007 Trolley for Inno® Note. Room for 51 Inno® Notes.	58,5 Kg	1532 x 662 x 1199 mm	19.942
	CHAIR TROLLEY - 200X0 25 chairs without upholstery	33,5 Kg	1100 x 560 x 1970 mm	8.859
	CHAIR TROLLEY - 200X0 20 chairs with seat pad or 18 chairs with full upholstery	33,5 Kg	1100 x 560 x 1910 / 1980 mm	10.373
	SACK TROLLEY - 200X1 12 chairs without upholstery, 10 chairs with full upholstery			4.918

FourCast® 2 Four - Veneer

Design by Strand+Hvass

[Content ↗](#)

SURCHARGE		Price (SEK)
FRAME OPTIONAL	 7 A D E F M N O Q S T	194
	 P	473

20% rabatt ska dras av på angivna priser

FourCast® 2 Line

Design by Strand+Hvass

[Content ↗](#)



FEATURES

- Armrest options
- Linking device optional on frames or under seat
- Monochrome powder coating on frames options
- Polyamide glides as standard
- Inno® Note tablet options
- Stackable on matching trolley
- Outdoor options
- We do not recommend suspensions for fully upholstered version



For product information visit oceefour.com ↗

SHELL COLOURS

Standard Polypropylene



FRAME COLOURS

Standard



Optional Polypropylene

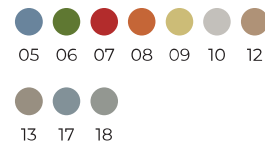

Frame optional*





For full colour details [go to page 236](#) ↗

Product	Description (Item nr)	Weight (Kg)	Stacking on floor	Dimensions (mm)	Band	Standard PP (SEK)	Optional PP (SEK)
	33200 FourCast® 2 Line, Polypropylene shell	5.7	12		-	2.776	2.967
	33210 FourCast® 2 Line, Seat pad	6.7	10		1 2 3 4 5 6 7 8 10	4.038 4.133 4.228 4.322 4.414 4.510 4.605 4.699 4.917	4.229 4.324 4.419 4.513 4.605 4.701 4.796 4.890 5.108
	33230 FourCast® 2 Line, Fully upholstered	5	8		1 2 3 4 5 6 7 8 10	5.485 5.706 5.929 6.149 6.368 6.589 6.811 7.030 7.516	
	33300 FourCast® 2 Line with Armrests, Polypropylene shell	6.5	12		-	3.715	3.906

FourCast® 2 Line

Design by Strand+Hvass

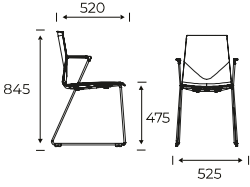
[Content ↗](#)

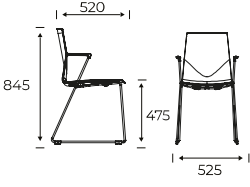







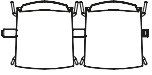

Product	Description (Item nr)	Weight (Kg)	Stacking on floor	Dimensions (mm)	Band	Standard PP (SEK)	Optional PP (SEK)					
	33310 FourCast® 2 Line with Armrests, Seat pad	7.4	10		1	4.977	5.168					
					2	5.072	5.263					
					3	5.167	5.358					
					4	5.261	5.452					
					5	5.353	5.544					
					6	5.449	5.640					
					7	5.544	5.735					
					8	5.638	5.829					
					10	5.856	6.047					
						33330 FourCast® 2 Line with Armrests, Fully upholstered	5.8	8		1	6.424	
										2	6.645	
3	6.868											
4	7.088											
5	7.307											
6	7.528											
7	7.750											
8	7.969											
10	8.455											

20% rabatt ska dras av på angivna priser

FourCast® 2 Line

Design by Strand+Hvass

[Content ↗](#)

ACCESSORIES	Description	Weight (Kg)	Dimensions (mm)	Price (SEK)
	CHAIR FEET Felt glides, set of 4 pcs. height + 0,2 cm	1,82 g x 4		208
	CHAIR FEET Teflon glides, set of 4 pcs. Chair height + 0,2 cm	2,75 g x 4		208
	LINKING DEVICE Chair linking	0,4 KG	C/C 535 mm C/C with armrest 585 mm C/C with Loop armrest 625 mm	417
	LINKING DEVICE Chair linking		C/C 540 mm C/C with armrest 540 mm	390
	GRIP HOLE Available for chairs without inside – and full upholstery			189
	INNO Inno® Note in black, removable and foldable. Not available for chairs with Loop armrest and chairs with wooden legs.	1,4 KG	225 x 325 x 10 mm	1.522
	SEAT ROW NUMBER - ACSR0201 11 mm - no. 1 -25	29 g		1.579
	SEAT ROW NUMBER - ACSR0202 11 mm - no. 26 -50	29 g		1.579
	INNO@NOTE TROLLEY - 20100007 Trolley for Inno® Note. Room for 51 Inno® Notes.	58,5 Kg	1532 x 662 x 1199 mm	19.942
	CHAIR TROLLEY - 200X0 30 chairs without upholstery	33,5 Kg	1100 x 560 x 1970 mm	8.859
	CHAIR TROLLEY - 200X0 19 chairs with seat pad or 20 chairs with full upholstery	33,5 Kg	1100 x 560 x 1910 / 1980 mm	10.373
	SACK TROLLEY - 200X1 12 chairs without upholstery, 10 chairs with full upholstery			4.918

SURCHARGE		Price (SEK)
FRAME OPTIONAL	 7 A D E F M N O Q S T	194

FourCast® 2 Line - Veneer

Design by Strand+Hvass

[Content](#) ↗



FEATURES

- Armrest options
- Linking device optional on frames or under seat
- Monochrome powder coating on frames options
- Polyamide glides as standard
- Inno® Note tablet options
- Stackable on matching trolley
- We do not recommend suspensions to black lacquered versions



For product information visit oceefour.com ↗

SHELL COLOURS

Veneer



FRAME COLOURS

Standard



Frame optional*



For full colour details [go to page 236](#) ↗









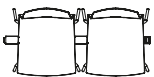

Product	Description (Item nr)	Weight (Kg)	Stacking on floor	Dimensions (mm)	Band	Veneer (SEK)
	33240 FourCast® 2 Line, Wooden shell	4.3	12		-	3.698
	33250 FourCast® 2 Line, Seat pad, wooden shell	5.6	10		1 2 3 4 5 6 7 8 10	4.960 5.055 5.150 5.244 5.336 5.432 5.527 5.621 5.839
	33340 FourCast® 2 Line with Armrests, Wooden shell	5	8		-	4.637
	33350 FourCast® 2 Line with Armrests, Seat pad, wooden shell	6.4	10		1 2 3 4 5 6 7 8 10	5.899 5.994 6.089 6.183 6.275 6.371 6.466 6.560 6.778

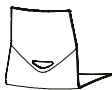
20% rabatt ska dras av på angivna priser

FourCast® 2 Line - Veneer

Design by Strand+Hvass

[Content ↗](#)

ACCESSORIES	Description	Weight (Kg)	Dimensions (mm)	Price (SEK)
	CHAIR FEET Felt glides, set of 4 pcs. height + 0,2 cm	1,82 g x 4		208
	CHAIR FEET Teflon glides, set of 4 pcs. Chair height + 0,2 cm	2,75 g x 4		208
	LINKING DEVICE Chair linking	0,4 KG	C/C 535 mm C/C with armrest 585 mm C/C with Loop armrest 625 mm	417
	LINKING DEVICE Chair linking		C/C 540 mm C/C with armrest 540 mm	390
	GRIP HOLE Available for chairs without inside – and full upholstery			189
	INNO Inno® Note in black, removable and foldable. Not available for chairs with Loop armrest and chairs with wooden legs.	1,4 KG	225 x 325 x 10 mm	1.522
	SEAT ROW NUMBER - ACSR0201 11 mm - no. 1 -25	29 g		1.579
	SEAT ROW NUMBER - ACSR0202 11 mm - no. 26 -50	29 g		1.579
	INNO@NOTE TROLLEY - 20100007 Trolley for Inno® Note. Room for 51 Inno® Notes.	58,5 Kg	1532 x 662 x 1199 mm	19.942
	CHAIR TROLLEY - 200X0 30 chairs without upholstery	33,5 Kg	1100 x 560 x 1970 mm	8.859
	CHAIR TROLLEY - 200X0 19 chairs with seat pad or 20 chairs with full upholstery	33,5 Kg	1100 x 560 x 1910 / 1980 mm	10.373
	SACK TROLLEY - 200X1 12 chairs without upholstery, 10 chairs with full upholstery			4.918

SURCHARGE		Price (SEK)
FRAME OPTIONAL	 7 A D E F M N O Q S T	194

FourCast® 2 Counter

Design by Strand+Hvass

[Content ↗](#)



FEATURES

- Fits table height 90 cm
- Stackable on floor
- Polyamide glides as standard
- Monochrome powder coating on frames options
- Outdoor options
- We do not recommend suspensions to fully upholstered version



For product information visit oceefour.com ↗

SHELL COLOURS

Standard Polypropylene



FRAME COLOURS

Standard



Optional Polypropylene

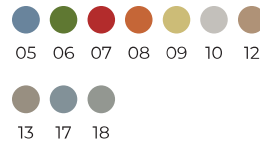

Frame optional*



For full colour details [go to page 236](#) ↗



Product	Description (Item nr)	Weight (Kg)	Stacking on floor	Dimensions (mm)	Band	Standard PP (SEK)	Optional PP (SEK)
	33800 FourCast® 2 Counter, Polypropylene shell	6.6	4		-	3.730	3.921
	33810 FourCast® 2 Counter, Seat pad	7.5	4		1 2 3 4 5 6 7 8 10	4.992 5.087 5.182 5.276 5.368 5.464 5.559 5.653 5.871	5.183 5.278 5.373 5.467 5.559 5.655 5.750 5.844 6.062
	33830 FourCast® 2 Counter, Fully upholstered	7.1	4		1 2 3 4 5 6 7 8 10	6.439 6.660 6.883 7.103 7.322 7.543 7.765 7.984 8.470	

20% rabatt ska dras av på angivna priser

FourCast® 2 Counter

Design by Strand+Hvass

[Content ↗](#)

ACCESSORIES	Description	Weight (Kg)	Dimensions (mm)	Price (SEK)
	CHAIR FEET Felt glides, set of 4 pcs. height + 0,2 cm	1,82 g x 4		208
	CHAIR FEET Teflon glides, set of 4 pcs. Chair height + 0,2 cm	2,75 g x 4		208
	GRIP HOLE Available for chairs without inside – and full upholstery			189
SURCHARGE				Price (SEK)
FRAME OPTIONAL	 7 A D E F M N O Q S T			194

FourCast® 2 Counter - Veneer

Design by Strand+Hvass

[Content](#) ↗



FEATURES

- Fits table height 90 cm
- Stackable on floor
- Polyamide glides as standard
- Monochrome powder coating on frames options
- We do not recommend suspensions to black lacquered versions



For product information visit oceefour.com ↗

SHELL COLOURS

Veneer



FRAME COLOURS

Standard



Frame optional*



For full colour details [go to page 236](#) ↗

Product	Description (Item nr)	Weight (Kg)	Stacking on floor	Dimensions (mm)	Band	Veneer (SEK)																		
	33840 FourCast® 2 Counter, Wooden shell	7.2	4		-	4.652																		
	33850 FourCast® 2 Counter, Seat pad, wooden shell	8.6	4		<table border="1"> <tr><td>1</td><td>5.914</td></tr> <tr><td>2</td><td>6.009</td></tr> <tr><td>3</td><td>6.104</td></tr> <tr><td>4</td><td>6.198</td></tr> <tr><td>5</td><td>6.290</td></tr> <tr><td>6</td><td>6.386</td></tr> <tr><td>7</td><td>6.481</td></tr> <tr><td>8</td><td>6.575</td></tr> <tr><td>10</td><td>6.793</td></tr> </table>	1	5.914	2	6.009	3	6.104	4	6.198	5	6.290	6	6.386	7	6.481	8	6.575	10	6.793	
1	5.914																							
2	6.009																							
3	6.104																							
4	6.198																							
5	6.290																							
6	6.386																							
7	6.481																							
8	6.575																							
10	6.793																							

ACCESSORIES	Description	Weight (Kg)	Dimensions (mm)	Price (SEK)
	CHAIR FEET Felt glides, set of 4 pcs. height + 0,2 cm	1,82 g x 4		208
	CHAIR FEET Teflon glides, set of 4 pcs. Chair height + 0,2 cm	2,75 g x 4		208
	GRIP HOLE Available for chairs without inside – and full upholstery			189

20% rabatt ska dras av på angivna priser

Content / Seating / FourCast® 2 Counter

FourCast® 2 Counter - Veneer

Design by Strand+Hvass

[Content ↗](#)

SURCHARGE		Price (SEK)
FRAME OPTIONAL	 <p>7 A D E F M N O Q S T</p>	194

FourCast® 2 High

Design by Strand+Hvass

[Content ↗](#)



FEATURES

- Fits table height 105 cm
- Stackable on floor
- Polyamide glides as standard
- Monochrome powder coating on frames options
- Outdoor options
- We do not recommend suspensions to fully upholstered version



For product information visit oceefour.com ↗

SHELL COLOURS

Standard Polypropylene



Optional Polypropylene

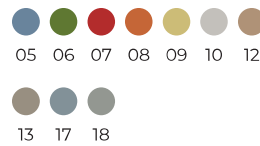

FRAME COLOURS

Standard



Frame optional*



For full colour details [go to page 236](#) ↗



Product	Description (Item nr)	Weight (Kg)	Stacking on floor	Dimensions (mm)	Band	Standard PP (SEK)	Optional PP (SEK)
	33900 FourCast® 2 High, Polypropylene shell	7.3	4		-	3.815	4.006
	33910 FourCast® 2 High, Seat pad	8.3	4		1 2 3 4 5 6 7 8 10	5.077 5.172 5.267 5.361 5.453 5.549 5.644 5.738 5.956	5.268 5.363 5.458 5.552 5.644 5.740 5.835 5.929 6.147
	33930 FourCast® 2 High, Fully upholstered	7.8	4		1 2 3 4 5 6 7 8 10	6.524 6.745 6.968 7.188 7.407 7.628 7.850 8.069 8.555	

20% rabatt ska dras av på angivna priser

FourCast® 2 High

Design by Strand+Hvass

[Content ↗](#)

ACCESSORIES	Description	Weight (Kg)	Dimensions (mm)	Price (SEK)
	CHAIR FEET Felt glides, set of 4 pcs. height + 0,2 cm	1,82 g x 4		208
	CHAIR FEET Teflon glides, set of 4 pcs. Chair height + 0,2 cm	2,75 g x 4		208
	GRIP HOLE Available for chairs without inside – and full upholstery			189
SURCHARGE				Price (SEK)
FRAME OPTIONAL	 7 A D E F M N O Q S T			194

FourCast® 2 High - Veneer

Design by Strand+Hvass

[Content](#) ↗



FEATURES

- Fits table height 105 cm
- Stackable on floor
- Polyamide glides as standard
- Monochrome powder coating on frames options
- We do not recommend suspensions to black lacquered versions



For product information visit oceefour.com ↗

SHELL COLOURS

Veneer



FRAME COLOURS



Standard



Frame optional*

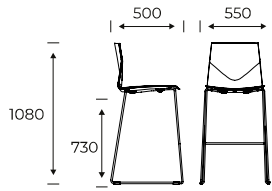

For full colour details [go to page 236](#) ↗

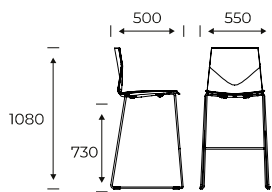
Product	Description (Item nr)	Weight (Kg)	Stacking on floor	Dimensions (mm)	Band	Veneer (SEK)
	33940 FourCast® 2 High, Wooden shell	8	4		-	4.737
	33950 FourCast® 2 High, Seat pad, wooden shell	9.4	4		1 2 3 4 5 6 7 8 10	5.999 6.094 6.189 6.283 6.375 6.471 6.566 6.660 6.878

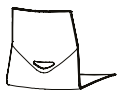
ACCESSORIES	Description	Weight (Kg)	Dimensions (mm)	Price (SEK)
	CHAIR FEET Felt glides, set of 4 pcs. height + 0,2 cm	1,82 g x 4		208
	CHAIR FEET Teflon glides, set of 4 pcs. Chair height + 0,2 cm	2,75 g x 4		208
	GRIP HOLE Available for chairs without inside – and full upholstery			189

20% rabatt ska dras av på angivna priser

FourCast® 2 High - Veneer

Design by Strand+Hvass

[Content ↗](#)

SURCHARGE		Price (SEK)
FRAME OPTIONAL	 <p>7 A D E F M N O Q S T</p>	194

FourCast® 2 Counter Four

Design by Strand+Hvass

[Content ↗](#)



FEATURES

- Fits table height 90 cm
- Stackable on floor
- Polyamide glides as standard
- Monochrome powder coating on frames options
- We do not recommend suspensions to fully upholstered version



For product information visit oceefour.com ↗

SHELL COLOURS

Standard Polypropylene



FRAME COLOURS

Standard



Optional Polypropylene

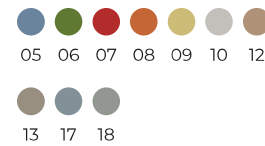

Frame optional*



For full colour details [go to page 236](#) ↗



Product	Description (Item nr)	Weight (Kg)	Stacking on floor	Dimensions (mm)	Band	Standard PP (SEK)	Optional PP (SEK)
	34000 FourCast® 2 Counter Four, Polypropylene shell	7.7	4		-	3.492	3.683
	34010 FourCast® 2 Counter Four, Seat pad	8.6	4		1 2 3 4 5 6 7 8 10	4.754 4.849 4.944 5.038 5.130 5.226 5.321 5.415 5.633	4.945 5.040 5.135 5.229 5.321 5.417 5.512 5.606 5.824
	34030 FourCast® 2 Counter Four, Fully upholstered	8.2	4		1 2 3 4 5 6 7 8 10	6.201 6.422 6.645 6.865 7.084 7.305 7.527 7.746 8.232	

20% rabatt ska dras av på angivna priser [Content / seatur / FourCast® 2 Counter Four](#)

FourCast® 2 Counter Four

Design by Strand+Hvass

[Content ↗](#)

ACCESSORIES	Description	Weight (Kg)	Dimensions (mm)	Price (SEK)
	CHAIR FEET Felt glides, set of 4 pcs. height + 0,2 cm	1,82 g x 4		208
	CHAIR FEET Teflon glides, set of 4 pcs. Chair height + 0,2 cm	2,75 g x 4		208
	GRIP HOLE Available for chairs without inside – and full upholstery			189
SURCHARGE				Price (SEK)
FRAME OPTIONAL	 7 A D E F M N O Q S T			194

FourCast® 2 Counter Four - Veneer

Design by Strand+Hvass

[Content](#) ↗



FEATURES

- Fits table height 90 cm
- Stackable on floor
- Polyamide glides as standard
- Monochrome powder coating on frames options
- We do not recommend suspensions to black lacquered versions



For product information visit oceefour.com ↗

SHELL COLOURS

Veneer



FRAME COLOURS

Standard



Frame optional*



For full colour details [go to page 236](#) ↗

Product	Description (Item nr)	Weight (Kg)	Stacking on floor	Dimensions (mm)	Band	Veneer (SEK)
	34040 FourCast® 2 Counter Four, Wooden shell	8.3	4		-	4,414
	34050 FourCast® 2 Counter Four, Seat pad, wooden shell	9.7	4		1 2 3 4 5 6 7 8 10	5,676 5,771 5,866 5,960 6,052 6,148 6,243 6,337 6,555

ACCESSORIES	Description	Weight (Kg)	Dimensions (mm)	Price (SEK)
	CHAIR FEET Felt glides, set of 4 pcs. height + 0,2 cm	1,82 g x 4		208
	CHAIR FEET Teflon glides, set of 4 pcs. Chair height + 0,2 cm	2,75 g x 4		208
	GRIP HOLE Available for chairs without inside – and full upholstery			189

20% rabatt ska dras av på angivna priser

FourCast® 2 Counter Four - Veneer

Design by Strand+Hvass

[Content ↗](#)

SURCHARGE		Price (SEK)
FRAME OPTIONAL	 <p>7 A D E F M N O Q S T</p>	194

FourCast® 2 High Four

Design by Strand+Hvass

[Content ↗](#)

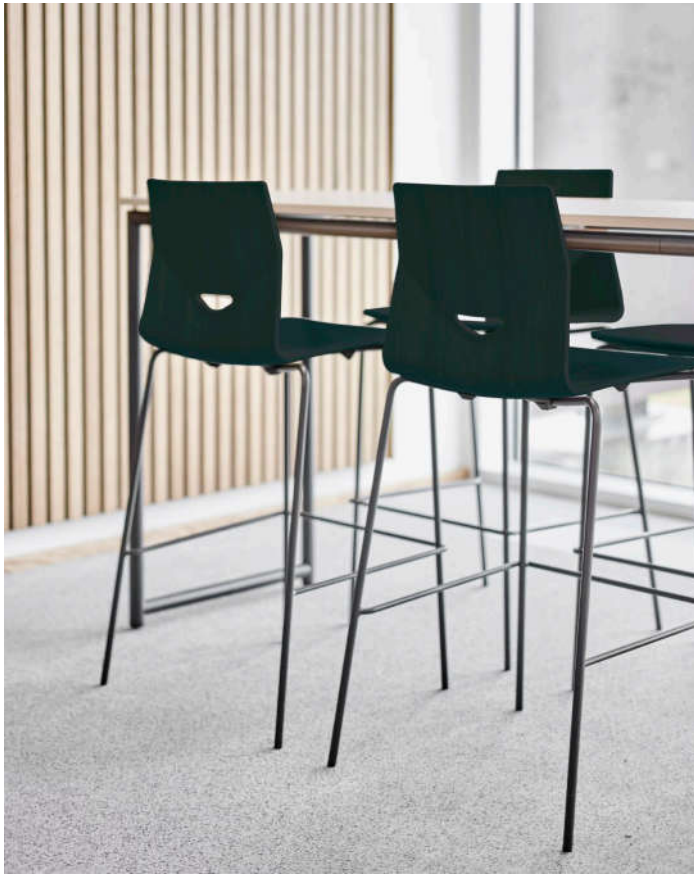

FEATURES

- Fits table height 105 cm
- Stackable on floor
- Polyamide glides as standard
- Monochrome powder coating on frames options
- We do not recommend suspensions to fully upholstered version



For product information visit oceefour.com ↗

SHELL COLOURS

Standard Polypropylene



FRAME COLOURS

Standard



Optional Polypropylene

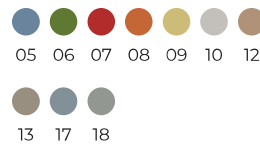

Frame optional*



For full colour details [go to page 236](#) ↗



Product	Description (Item nr)	Weight (Kg)	Stacking on floor	Dimensions (mm)	Band	Standard PP (SEK)	Optional PP (SEK)
	34100 FourCast® 2 High Four, Polypropylene shell	6.7	4		-	3.492	3.683
	34110 FourCast® 2 High Four, Seat pad	7.7	4		1 2 3 4 5 6 7 8 10	4.754 4.849 4.944 5.038 5.130 5.226 5.321 5.415 5.633	4.945 5.040 5.135 5.229 5.321 5.417 5.512 5.606 5.824
	34130 FourCast® 2 High Four, Fully upholstered	7.2	4		1 2 3 4 5 6 7 8 10	6.201 6.422 6.645 6.865 7.084 7.305 7.527 7.746 8.232	

20% rabatt ska dras av på angivna priser

FourCast® 2 High Four

Design by Strand+Hvass

[Content ↗](#)

ACCESSORIES	Description	Weight (Kg)	Dimensions (mm)	Price (SEK)
	CHAIR FEET Felt glides, set of 4 pcs. height + 0,2 cm	1,82 g x 4		208
	CHAIR FEET Teflon glides, set of 4 pcs. Chair height + 0,2 cm	2,75 g x 4		208
	GRIP HOLE Available for chairs without inside – and full upholstery			189
SURCHARGE				Price (SEK)
FRAME OPTIONAL	 7 A D E F M N O Q S T			194

FourCast® 2 High Four - Veneer

Design by Strand+Hvass

[Content](#) ↗



FEATURES

- Fits table height 105 cm
- Stackable on floor
- Polyamide glides as standard
- Monochrome powder coating on frames options
- We do not recommend suspensions to black lacquered versions



For product information visit oceefour.com ↗

SHELL COLOURS

Veneer



FRAME COLOURS

Standard



Frame optional*



For full colour details [go to page 236](#) ↗

Product	Description (Item nr)	Weight (Kg)	Stacking on floor	Dimensions (mm)	Band	Veneer (SEK)
	34140 FourCast® 2 High Four, Wooden shell	7.4	4		-	4,414
	34150 FourCast® 2 High Four, Seat pad, wooden shell	8.8	4		1 2 3 4 5 6 7 8 10	5,676 5,771 5,866 5,960 6,052 6,148 6,243 6,337 6,555

ACCESSORIES	Description	Weight (Kg)	Dimensions (mm)	Price (SEK)
	CHAIR FEET Felt glides, set of 4 pcs. height + 0,2 cm	1,82 g x 4		208
	CHAIR FEET Teflon glides, set of 4 pcs. Chair height + 0,2 cm	2,75 g x 4		208
	GRIP HOLE Available for chairs without inside – and full upholstery			189

20% rabatt ska dras av på angivna priser

FourCast® 2 High Four - Veneer

Design by Strand+Hvass

[Content ↗](#)

SURCHARGE		Price (SEK)
FRAME OPTIONAL	 <p>7 A D E F M N O Q S T</p>	194

FourCast® 2 Wheeler

Design by Strand+Hvass

[Content](#) ↗



FEATURES

- Inno® Tab, flexible and rotating writing tablet options
- Gas lift, 41 - 57,5 cm
- Free Float options
- Black base with castors as standard
- Aluminium base options
- We do not recommend suspensions to fully upholstered version



For product information visit oceefour.com ↗

SHELL COLOURS

Standard Polypropylene



Optional Polypropylene



FRAME COLOURS

Standard



Frame optional*



For full colour details [go to page 236](#) ↗

Product	Description (Item nr)	Weight (Kg)	Dimensions (mm)	Band	Standard PP (SEK)	Optional PP (SEK)
	35004 FourCast® 2 Wheeler, Polypropylene shell, Without tilt with gas	7.3		-	3.016	3.207
	35014 FourCast® 2 Wheeler, Seat pad, Without tilt with gas	7.9		1 2 3 4 5 6 7 8 10	4.278 4.373 4.468 4.562 4.654 4.750 4.845 4.939 5.157	4.469 4.564 4.659 4.753 4.845 4.941 5.036 5.130 5.348
	35034 FourCast® 2 Wheeler, Fully upholstered, Without tilt with gas	6.2		1 2 3 4 5 6 7 8 10	5.725 5.946 6.169 6.389 6.608 6.829 7.051 7.270 7.756	
	35005 FourCast® 2 Wheeler, Polypropylene shell, With tilt with gas	7.3		-	3.380	3.571

20% rabatt ska dras av på angivna priser