

# Statligt Ramavtal - Möbler och inredning

Delområde – Arbetsstolar



Sitland

Produktlista nr 4



**30% Rabatt skall dras av angivna priser**

AB Evert Lindelöf Inredningsservice

556071-3462

Avtalsnummer 23.3-8004-18:023

*AB Evert Lindelöf*

# Spirit

design Baldanzi – Novelli

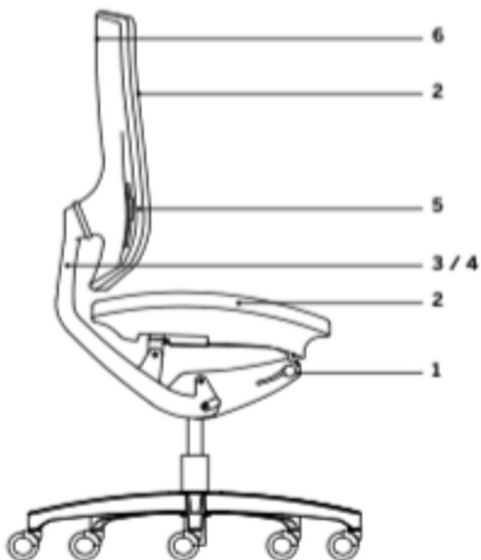

## TEKNISK SPECIFIKATION

- 1 Höjd justering
- 2 Ergonomisk sits, PU, "Comfort Air" teknologi
- 3 Ryggstolpe i aluminium, svart eller polerad
- 4 Patenterad "freedom" mekanism
- 5 Svankstödsjustering
- 6 Klädhängare, krok

30% Rabatt skall dras av angivna priser



# Spirit

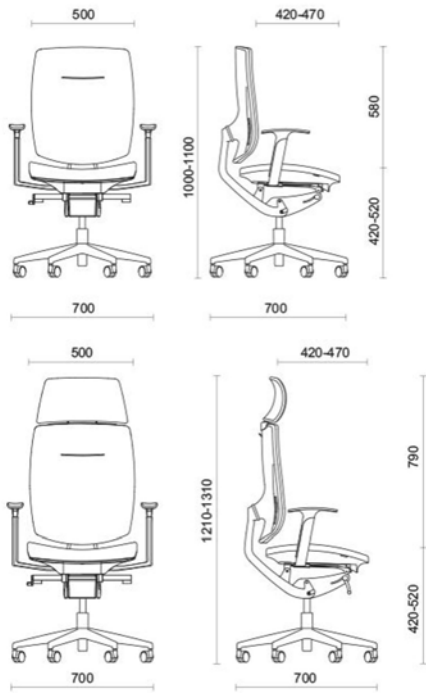

## Grundutförande:

Klädd rygg och sits, val nedan  
 Ryggens ram/skal i PA  
 Ryggstolpe i svart aluminium  
 5-fotkruss  $\varnothing$  700 mm, stålförstärkt PA  
 Hjul  $\varnothing$  65 mm – val av hjul, ändra position 9 i artikel.nr  
 Armstöd, 4D höjd, bredd, djup, vinkel

Höjdjustering  
 Synkronmekanism låsbar i 11 lägen, justering av gungans hårdhet med hjälp av ett sidohandtag (vev), anti-chock-system  
 Negativ sits-vinkel 4, dynamisk "freedom-rygg" som följer dina rörelser  
 Svankstödsjustering  
 Sitsdjupsjustering

## Tillval:

Nackstöd, justerbar i höjd  
 Hjul  $\varnothing$  65 mm, ihåliga – val nedan, ändra position 9 i artikel.nr  
 Armstödssupport, ryggstolpe och 5-fotkruss  $\varnothing$  700 mm, polerad aluminium – val nedan, ändra position 4, 7 och 8 i artikel.nr

Volym: 0,337 m<sup>2</sup> / 0,409 m<sup>3</sup>  
 Netto vikt: 17,00 kg / 20,45 kg  
 Gross vikt: 21,60 kg / 25,55 kg  
 Förpackade: 1 krt  
 COM, tyngtgång sits 0,90-1,20 m – Tygbredd: 1,4 m

	Pg.1	Pg.2	Pg.3	Pg.4	Pg.5	Pg.9	Pg.B	Pg.C	
	NX-AL	AB-ME	CH	MF-SC-ST-COM	CS-SY	RM	SX	TS	
1 2 3 4 5 6 7 8 9 10									
S P O 1 2 3 1 1 - 0	Grundutförande - välj hjul nr. 7, 8 eller 9	15 660 kr	16 065 kr	16 395 kr	16 740 kr	17 280 kr	17 760 kr	18 360 kr	20 625 kr
1 2 3 4 5 6 7 8 9 10									
S P D 1 2 3 1 1 - 0	Grundutförande - välj hjul nr. 7, 8 eller 9 inkl. nackstöd	18 240 kr	18 780 kr	19 275 kr	19 680 kr	20 430 kr	20 910 kr	21 555 kr	24 135 kr

1	2	3	4	5	6	7	8	9	10		
-	-	-	-	-	-	-	-	7	-	$\varnothing$ 65 mm, obromsat, för matta	0
-	-	-	-	-	-	-	-	8	-	$\varnothing$ 65 mm, bromsat, för matta	0
-	-	-	-	-	-	-	-	9	-	$\varnothing$ 65 mm, bromsat, för hårt golv	0
-	-	-	-	-	-	-	-	N	-	$\varnothing$ 65 mm, ihåligt, svart	tillägg 435 kr
-	-	-	-	-	-	-	-	C	-	$\varnothing$ 65 mm, ihåligt, krom	tillägg 495 kr

1	2	3	4	5	6	7	8	9	10		
-	-	-	4	-	-	3	4	-	-	Ryggstolpe och 5-fotkruss $\varnothing$ 700 mm, polerad alu 4D armstöd, support i polerad alu	tillägg 7455



# Team Strike Evo

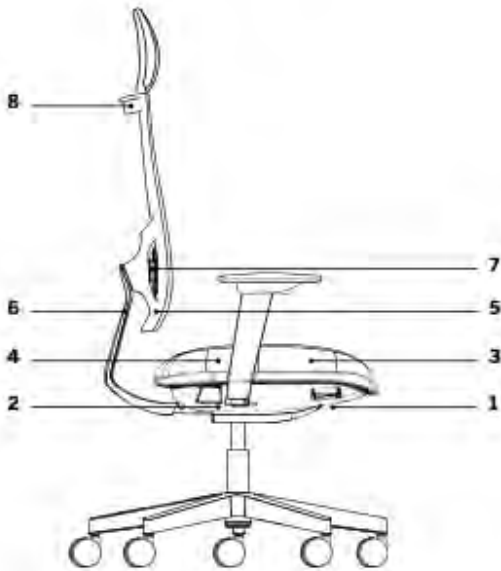

## TEKNISK SPECIFIKATION

- 1 Höjd justering
- 2 Sitsdjupsjustering med självjusterande (utifrån kroppsvikt) synkronmekanism, låsbar i 5 positioner, med anti-chock system
- 3 Ergonomisk sits, PU
- 4 Sitskärna i PA
- 5 Rygg i mesh eller tygmembran, ram i PA
- 6 Ryggstolpe i aluminium, svart, vit eller polerad alu
- 7 Svankstödsjustering
- 8 Handtag

**EN** 1335-1:2020  
TYPE A / AX  
D.Lgs. 61/08

30% Rabatt skall dras av angivna priser



# Team Strike EVO Executive

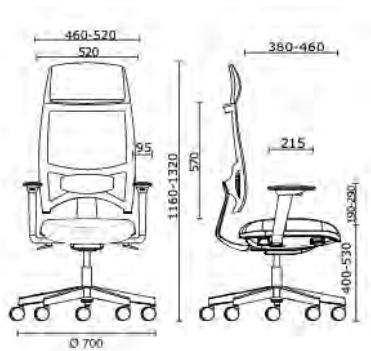

Volym:  
Netto vikt:  
Gross vikt:  
Förpackade:  
COM, tygätgång sits

0,23 m2 / 0,29 m3  
13,20 kg / 13,95 kg  
16,20 kg / 17,35 kg  
1 krt  
0,50 – Tygbredd: 1,4 m

## Grundutförande:

Klädd sits, rygg i mesh, tygmembran eller stoppad/klädd  
Ryggs ram/skal i PA, svart  
Ryggstolpe i svart aluminium  
5-fotkryss  $\varnothing$  700 mm, stålförstärkt PA  
Hjul  $\varnothing$  65 mm – val av hjul, ändra position 9 i artikel.nr

## Höjdjustering

Självjusterande synkronmekanism utifrån kroppsvikt, låsbar i 4 positioner, anti-chock-system  
Svankstödsjustering  
Sitsdjupsjustering

## Tillval:

Nackstöd i PU, svart, justerbar i höjd. Vid val stoppad sits/rygg är nackstödet stoppat och klätt.  
Hjul  $\varnothing$  65 mm, ihålliga – val nedan, ändra position 9 i artikel.nr  
Ryggstolpe och 5-fotkryss  $\varnothing$  700 mm, polerad aluminium eller vitt – val nedan, ändra position 4 och 8 i artikel.nr  
Armstöd, 2D justerbar i höjd, bredd eller 4D höjd, bredd, djup, vinkel – val nedan, ändra position 7, packas i samma krt som stol. Går att beställa separat då med eget artikelnummer.

1	2	3	4	5	6	7	8	9	10		Pg. 1	Pg. 2	Pg. 3	Pg. 4	Pg. 5	Pg. 9	Pg. A	
T	T	D	1	2	1	0	1	-	0	Grundutförande - välj hjul nr. 7, 8 eller 9	Rygg mesh RF	NX-AL-BN	AB-ME	CH	MF-SC-COM	SY-CS	RM	SX
											8 805 kr	8 970 kr	9 045 kr	9 255 kr	9 420 kr	9 780 kr	10 170 kr	
T	T	D	1	2	1	0	1	-	0	Grundutförande - välj hjul nr. 7, 8 eller 9	Rygg mesh RR	NX-AL-BN	AB-ME	CH	MF-SC-COM	SY-CS	RM	SX
											8 985 kr	9 150 kr	9 225 kr	9 435 kr	9 600 kr	9 960 kr	10 380 kr	
T	T	D	1	2	1	0	1	-	0	Grundutförande - välj hjul nr. 7, 8 eller 9	Rygg mesh RY	NX-AL-BN	AB-ME	CH	MF-SC-COM	SY-CS	RM	SX
											9 225 kr	9 390 kr	9 465 kr	9 675 kr	9 840 kr	10 230 kr	10 650 kr	
T	T	D	1	2	1	0	1	-	0	Grundutförande - välj hjul nr. 7, 8 eller 9	Rygg TYG-MEMBRAN	BN	AB-ME	CH	MF-COM	CS	RM	
											9 435 kr	9 735 kr	9 930 kr	10 260 kr	10 980 kr	11 655 kr		
T	T	A	1	2	1	0	1	-	0	Grundutförande - välj hjul nr. 7, 8 eller 9	Rygg STOPPAD TYGKLÄDD	NX-AL-BN	AB-ME	CH	MF-SC-COM	CS	RM	SX
											9 795 kr	10 020 kr	10 260 kr	10 650 kr	11 550 kr	12 405 kr	12 840 kr	
-	-	-	-	-	-	-	-	7	-	$\varnothing$ 65 mm, obromsat, för matta								0
-	-	-	-	-	-	-	-	8	-	$\varnothing$ 65 mm, bromsat, för matta								0
-	-	-	-	-	-	-	-	9	-	$\varnothing$ 65 mm, bromsat, för hårt golv								0
-	-	-	-	-	-	-	-	N	-	$\varnothing$ 65 mm, ihålligt, svart (Moebius)						tillägg		510 kr
-	-	-	-	-	-	-	-	C	-	$\varnothing$ 65 mm, ihålligt, vit (Moebius)						tillägg		510 kr

T	T	-	-	-	-	2	-	-	0	Armstöd 2D, svart (packas i samma krt som stol)	tillägg	1 110 kr
T	T	-	-	-	-	4	-	-	0	Armstöd 4D, svart (packas i samma krt som stol)	tillägg	1 350 kr
T	T	-	2	-	-	4	-	-	0	Armstöd 4D, vit (packas i samma krt som stol)	tillägg	1 545 kr
T	T	-	-	-	-	-	3	-	0	Version i svart, 5-fotkryss $\varnothing$ 700 mm, polerad alu	tillägg	750 kr
T	T	-	3	-	-	-	-	-	0	Version i svart med ryggstolpe, polerad aluminium	tillägg	795 kr
T	T	-	2	-	-	-	2	-	0	Version i vitt, 5-fotkryss i stålförstärkt nylon	tillägg	990 kr
T	T	-	2	-	-	-	3	-	0	Version i vitt, 5-fotkryss i polerad alu	tillägg	1 740 kr
T	T	-	-	-	-	-	-	1		Tilläggstjänst: Fullt monterad stol packad i krt	tillägg	555 kr

Volym: 0,53m3 - Netovikt: 13,20kg - Grossvikt: 17,20kg

30% Rabatt skall dras av angivna priser



# Team Strike EVO Manager

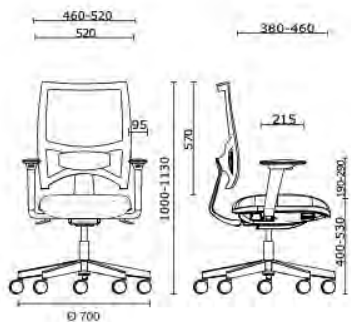

Volym:  
Netto vikt:  
Gross vikt:  
Förpackade:  
COM, tygätgång sits

0,23 m<sup>2</sup> / 0,29 m<sup>3</sup>  
13,20 kg / 13,95 kg  
16,20 kg / 17,35 kg  
1 krt  
0,50 – Tygbredd: 1,4 m

## Grundutförande:

Klädd sits, rygg i mesh, tygmembran eller stoppad/klädd  
Ryggens ram/skal i PA, svart  
Ryggstolpe i svart aluminium  
5-fotkryss  $\varnothing$  700 mm, stålförstärkt PA  
Hjul  $\varnothing$  65 mm – val av hjul, ändra position 9 i artikel.nr

## Höjdjustering

Självjusterande synkronmekanism utifrån kroppsvikt, låsbar i 5 lägen, anti-chock-system  
Svankstödsjustering  
Sitsdjupsjustering

## Tillval:

Nackstöd i PU, svart, justerbar i höjd  
Hjul  $\varnothing$  65 mm, ihåliga – val nedan, ändra position 9 i artikel.nr  
Ryggstolpe och 5-fotkryss  $\varnothing$  700 mm, polerad aluminium eller vitt – val nedan, ändra position 4 och 8 i artikel.nr  
Armstöd, 2D justerbar i höjd, bredd eller 4D höjd, bredd, djup, vinkel – val nedan, ändra position 7, packas i samma krt som stol. Går att beställa separat då med eget artikelnummer.

1	2	3	4	5	6	7	8	9	10			Pg.1	Pg.2	Pg.3	Pg.4	Pg.5	Pg.9	Pg.A
T	T	O	1	2	1	0	1	-	0	Grundutförande - välj hjul nr. 7, 8 eller 9	Rygg mesh RF	NX-AL-BN	AB-ME	CH	MF-SC-COM	CS	RM	SX
												7 125 kr	7 275 kr	7 305 kr	7 545 kr	7 710 kr	7 980 kr	8 340 kr
T	T	O	1	2	1	0	1	-	0	Grundutförande - välj hjul nr. 7, 8 eller 9	Rygg mesh RR	NX-AL-BN	AB-ME	CH	MF-SC-COM	CS	RM	SX
												7 320 kr	7 470 kr	7 500 kr	7 740 kr	7 905 kr	8 265 kr	8 640 kr
T	T	O	1	2	1	0	1	-	0	Grundutförande - välj hjul nr. 7, 8 eller 9	Rygg mesh RY	NX-AL-BN	AB-ME	CH	MF-SC-COM	CS	RM	SX
												7 560 kr	7 710 kr	7 740 kr	7 980 kr	8 145 kr	8 505 kr	8 895 kr
T	T	O	1	2	1	0	1	-	0	Grundutförande - välj hjul nr. 7, 8 eller 9	Rygg TYG-MEMBRAN	BN	AB-ME	CH	MF-COM	CS	RM	
												7 770 kr	8 055 kr	8 205 kr	8 565 kr	9 255 kr	9 900 kr	
T	T	B	1	2	1	0	1	-	0	Grundutförande - välj hjul nr. 7, 8 eller 9	Rygg STOPPAD TYGKLÄDD	NX-AL-BN	AB-ME	CH	MF-SC-COM	CS	RM	SX
												8 160 kr	8 340 kr	8 940 kr	9 120 kr	9 600 kr	10 050 kr	10 890 kr

1	2	3	4	5	6	7	8	9	10										
-	-	-	-	-	-	-	-	7	-	$\varnothing$ 65 mm, obromsat, för matta								0	
-	-	-	-	-	-	-	-	8	-	$\varnothing$ 65 mm, bromsat, för matta								0	
-	-	-	-	-	-	-	-	9	-	$\varnothing$ 65 mm, bromsat, för hårt golv								0	
-	-	-	-	-	-	-	-	N	-	$\varnothing$ 65 mm, ihåligt, svart (Moebius)							tillägg	510 kr	
-	-	-	-	-	-	-	-	C	-	$\varnothing$ 65 mm, ihåligt, vit (Moebius)								tillägg	510 kr

1	2	3	4	5	6	7	8	9	10										
T	T	-	-	-	-	2	-	-	0	Armstöd 2D, svart (packas i samma krt som stol)								tillägg	1 110 kr
T	T	-	-	-	-	4	-	-	0	Armstöd 4D, svart (packas i samma krt som stol)								tillägg	1 350 kr
T	T	-	2	-	-	4	-	-	0	Armstöd 4D, vit (packas i samma krt som stol)								tillägg	1 545 kr
T	T	-	-	-	-	-	3	-	0	Version i svart, 5-fotkryss $\varnothing$ 700 mm, polerad alu								tillägg	750 kr
T	T	-	3	-	-	-	-	-	0	Version i svart med ryggstolpe, polerad aluminium								tillägg	795 kr
T	T	-	2	-	-	-	2	-	0	Version i vitt, 5-fotkryss i stålförstärkt nylon								tillägg	990 kr
T	T	-	2	-	-	-	3	-	0	Version i vitt, 5-fotkryss i polerad alu								tillägg	1 740 kr
T	T	-	-	-	-	-	-	1		Tilläggstjänst: Fullt monterad stol packad i krt								tillägg	555 kr

Volym: 0,53m<sup>3</sup> - Nettovikt: 13,20kg - Grossvikt: 17,20kg

30% Rabatt skall dras av angivna priser



# Team Strike Evo

Armstöd vid separat beställning eget artikelnummer

1 2 3 4 5 6 7 8 9 10

T	S	E	V	O	2	N	0	0	0	Armstöd 2D, svart PA, svart TPU-top	1 110 kr
T	S	E	V	O	4	N	0	0	0	Armstöd 4D, svart PA, svart TPU-top	1 350 kr
T	S	E	V	O	4	B	0	0	0	Armstöd 4D, vit PA, svart TPU-top	1 350 kr



# Team Strike

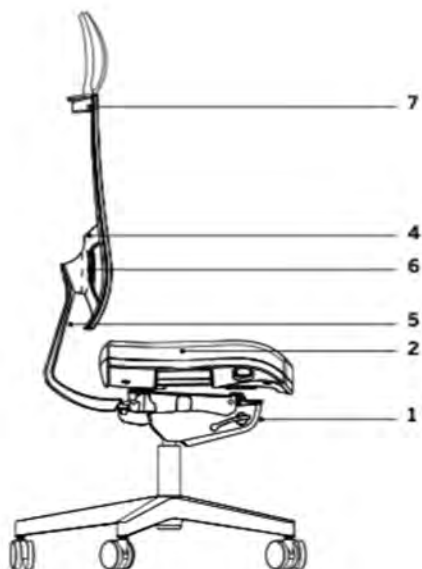

## TEKNISK SPECIFIKATION

- 1 Höjd justering
- 2 Ergonomisk sits, PU, "Comfort Air" teknologi
- 3 Inre struktur, PP förstärkt
- 4 Rygg struktur i PA med mesh
- 5 Ryggstolpe i aluminium, svart eller polerad
- 6 Svankstödsjustering
- 7 Handtag





# Team Strike Executive

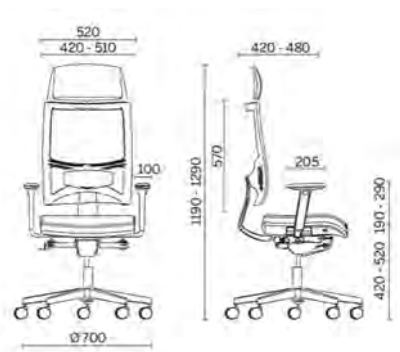

## Grundutförande:

Klädd sits, val nedan  
 Rygg i mesh  
 Ryggstolpe i svart aluminium  
 5-fotkryss  $\varnothing$  700 mm, stålförstärkt PA  
 Hjul  $\varnothing$  65 mm – val av hjul, ändra position 9 i artikel.nr

Höjdjustering  
 Synkronmekanism låsbar i 5 lägen, justering av gungans hårdhet med hjälp av ett sidohandtag (vev), anti-chock-system  
 Svankstödsjustering  
 Sitsdjupsjustering

## Tillval:

Nackstöd i PU, svart, justerbar i höjd  
 Hjul  $\varnothing$  65 mm, ihåliga – val nedan, ändra position 9 i artikel.nr  
 Ryggstolpe och 5-fotkryss  $\varnothing$  700 mm, polerad aluminium – val nedan, ändra position 4 och 8 i artikel.nr  
 Version i ljusgrå / aluminium – val nedan, ändra position 4 och 8 i artikel.nr  
 Armstöd, 2D justerbar i höjd, bredd – 3D höjd, djup, vinkel – 4D höjd, bredd, djup, vinkel (separat art.nr)

Volym: 0,287 m3  
 Netto vikt: 16,30 kg  
 Gross vikt: 19,70 kg  
 Förpackade: 1 krt  
 COM, tyngtgång sits 0,50 m – Tygbredd: 1,4 m

1	2	3	4	5	6	7	8	9	10			Pg.1	Pg.2	Pg.3	Pg.4	Pg.9	Pg.5	Pg.A
T	R	D	1	2	7	0	L	-	0	Grundutförande - välj hjul nr. 7, 8 eller 9	Rygg mesh RF	NX-AL-BN	AB-ME	CH-RR	MF-SC-ST-COM	RM	SY	NX+SX
												8 280 kr	8 370 kr	8 505 kr	8 730 kr	8 895 kr	9 075 kr	9 225 kr
T	R	D	1	2	7	0	L	-	0	Grundutförande - välj hjul nr. 7, 8 eller 9	Rygg mesh RP, RR	NX-AL-BN	AB-ME	CH-RR	MF-SC-ST-COM	RM	SY	NX+SX
												8 445 kr	8 550 kr	8 670 kr	8 880 kr	9 120 kr	9 270 kr	9 420 kr
T	R	D	1	2	7	0	L	-	0	Grundutförande - välj hjul nr. 7, 8 eller 9	Rygg mesh RY	NX-AL-BN	AB-ME	CH-RR	MF-SC-ST-COM	RM	SY	NX+SX
												8 685 kr	8 805 kr	8 895 kr	9 195 kr	9 405 kr	9 600 kr	9 690 kr

1	2	3	4	5	6	7	8	9	10										
-	-	-	-	-	-	-	-	7	-	$\varnothing$ 65 mm, obromsat, för matta								0	
-	-	-	-	-	-	-	-	8	-	$\varnothing$ 65 mm, bromsat, för matta								0	
-	-	-	-	-	-	-	-	9	-	$\varnothing$ 65 mm, bromsat, för hårt golv								0	
-	-	-	-	-	-	-	-	N	-	$\varnothing$ 65 mm, ihåligt, svart							tillägg	480 kr	
-	-	-	-	-	-	-	-	C	-	$\varnothing$ 65 mm, ihåligt, krom								tillägg	555 kr

1	2	3	4	5	6	7	8	9	10										
T	R	D	1	2	7	0	8	-	0	5-fotkryss $\varnothing$ 700 mm, polerad alu								tillägg	765
T	R	D	4	2	7	0	L	-	0	Ryggstolpe, polerad aluminium								tillägg	810
T	R	D	5	2	7	0	H	-	0	Version i ljusgrått, 5-fotkryss i stålförstärkt nylon								tillägg	660
T	R	D	5	2	7	0	8	-	0	Version i ljusgrått, 5-fotkryss i polerad alu								tillägg	1395

1	2	3	4	5	6	7	8	9										
T	R	B	R	0	3					Armstöd 2D, svart								1140 kr
T	R	B	R	0	5					Armstöd 4D, svart								1455 kr
T	R	B	R	0	5	G				Armstöd 4D, ljusgrå, svart top								1695 kr
T	R	B	R	E	G	0	2	0		Armstöd 4D, alu, svart top								3045 kr

30% Rabatt skall dras av angivna priser



# Team Strike Manager

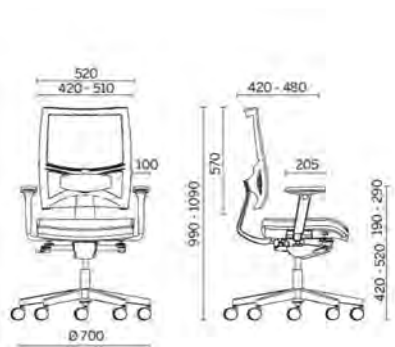

## Grundutförande:

Klädd sits, val nedan  
 Rygg i mesh  
 Ryggstolpe i svart aluminium  
 5-fotkryss  $\varnothing$  700 mm, stålförstärkt PA  
 Hjul  $\varnothing$  65 mm – val av hjul, ändra position 9 i artikel.nr

Höjdjustering  
 Synkronmekanism låsbar i 5 lägen, justering av gungans hårdhet med hjälp av ett sidohandtag (vev), anti-chock-system  
 Svankstödsjustering  
 Sitsdjupsjustering

## Tillval:

Hjul  $\varnothing$  65 mm, ihåliga – val nedan, ändra position 9 i artikel.nr  
 Ryggstolpe och 5-fotkryss  $\varnothing$  700 mm, polerad aluminium – val nedan, ändra position 4 och 8 i artikel.nr  
 Version i ljusgrå / aluminium – val nedan, ändra position 4 och 8 i artikel.nr  
 Armstöd, 2D justerbar i höjd, bredd – 3D höjd, djup, vinkel – 4D höjd, bredd, djup, vinkel (separat art.nr)

Volym: 0,287 m<sup>3</sup>  
 Netto vikt: 16,30 kg  
 Gross vikt: 19,70 kg  
 Förpackade: 1 krt  
 COM, tyngtgång sits 0,50 m – Tygbredd: 1,4 m

1	2	3	4	5	6	7	8	9	10			Pg.1	Pg.2	Pg.3	Pg.4	Pg.9	Pg.5	Pg.A
T	R	T	1	2	7	0	L	-	0	Grundutförande - välj hjul nr. 7, 8 eller 9	Rygg mesh RF	NX-AL-BN	AB-ME	CH-RR	MF-SC-ST-COM	RM	SY	NX+SX
												6 675 kr	6 870 kr	6 990 kr	7 170 kr	7 605 kr	7 665 kr	7 875 kr
1	2	3	4	5	6	7	8	9	10			NX-AL-BN	AB-ME	CH-RR	MF-SC-ST-COM	RM	SY	NX+SX
T	R	T	1	2	7	0	L	-	0	Grundutförande - välj hjul nr. 7, 8 eller 9	Rygg mesh RP, RR	NX-AL-BN	AB-ME	CH-RR	MF-SC-ST-COM	RM	SY	NX+SX
												6 915 kr	7 035 kr	7 215 kr	7 365 kr	7 770 kr	7 920 kr	8 085 kr
1	2	3	4	5	6	7	8	9	10			NX-AL-BN	AB-ME	CH-RR	MF-SC-ST-COM	RM	SY	NX+SX
T	R	T	1	2	7	0	L	-	0	Grundutförande - välj hjul nr. 7, 8 eller 9	Rygg mesh RY	NX-AL-BN	AB-ME	CH-RR	MF-SC-ST-COM	RM	SY	NX+SX
												7 110 kr	7 230 kr	7 395 kr	7 545 kr	8 010 kr	8 160 kr	8 295 kr

1	2	3	4	5	6	7	8	9	10									
-	-	-	-	-	-	-	7	-	-	$\varnothing$ 65 mm, obromsat, för matta								0
-	-	-	-	-	-	-	8	-	-	$\varnothing$ 65 mm, bromsat, för matta								0
-	-	-	-	-	-	-	9	-	-	$\varnothing$ 65 mm, bromsat, för hårt golv								0
-	-	-	-	-	-	-	N	-	-	$\varnothing$ 65 mm, ihåligt, svart							tillägg	480 kr
-	-	-	-	-	-	-	C	-	-	$\varnothing$ 65 mm, ihåligt, krom							tillägg	555 kr

1	2	3	4	5	6	7	8	9	10										
T	R	T	1	2	7	0	8	-	0	5-fotkryss $\varnothing$ 700 mm, polerad alu								tillägg	765
T	R	T	4	2	7	0	L	-	0	Ryggstolpe, polerad aluminium								tillägg	810
T	R	T	5	2	7	0	H	-	0	Version i ljusgrått, 5-fotkryss i stålförstärkt nylon								tillägg	510
T	R	T	5	2	7	0	8	-	0	Version i ljusgrått, 5-fotkryss i polerad alu								tillägg	1245

1	2	3	4	5	6	7	8	9										
T	R	B	R	0	3					Armstöd 2D, svart								1140 kr
T	R	B	R	0	5					Armstöd 4D, svart								1455 kr
T	R	B	R	0	5	G				Armstöd 4D, ljusgrå, svart top								1695 kr
T	R	B	R	E	G	0	2	0		Armstöd 4D, alu, svart top								3045 kr

30% Rabatt skall dras av angivna priser



# Soffio

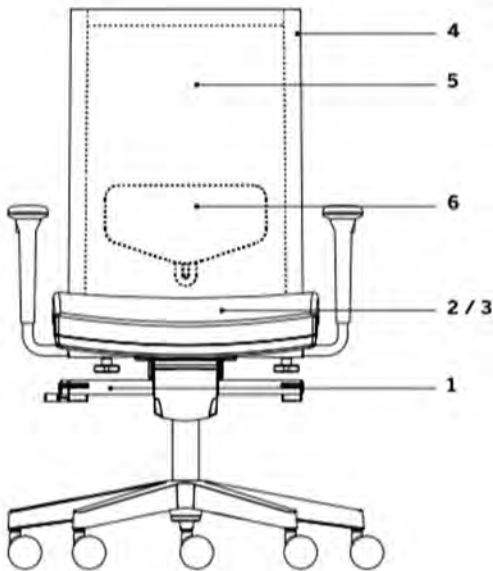

## TEKNISK SPECIFIKATION

- 1 Höjd justering
- 2 Ergonomisk sits, PU, "Comfort Air" teknologi
- 3 Inre struktur, PP, förstärkt
- 4 Rygg struktur i stål
- 5 Rygg i mesh eller helklädd med horisontell stickning på ryggens framsida
- 6 Svankstödsjustering



# Soffio - Klädd

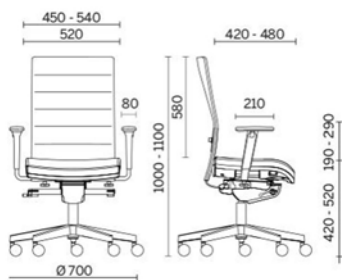

## Grundutförande:

Sits klädd, rygg helklädd med horisontell stickning på ryggens framsida, val nedan  
5-fotkryss  $\varnothing$  700 mm, stålförstärkt PA  
Hjul  $\varnothing$  65 mm – val av hjul, ändra position 9 i artikel.nr

## Höjjustering

Synkronmekanism låsbar i 5 lägen, justering av gungans hårdhet med hjälp av ett sidohandtag (vev), anti-chock-system

## Svanstödsjustering

Sitsdjupsjustering

## Tillval:

Hjul  $\varnothing$  65 mm, ihåliga – val nedan, ändra position 9 i artikel.nr

5-fotkryss  $\varnothing$  700 mm, polerad aluminium – val nedan, ändra position 8 i artikel.nr

Armstöd, 2D justerbar i höjd, bredd – 3D höjd, djup, vinkel – 4D höjd, bredd, djup, vinkel (separat art.nr)

Volym:	0,232 m <sup>3</sup>
Netto vikt:	14,60 kg
Gross vikt:	17,60 kg
Förpackade:	1 krt
COM, tyngtgång	1,20 m – Tygbredd: 1,4 m

1	2	3	4	5	6	7	8	9	10		Pg.1	Pg.2	Pg.3	Pg.4	Pg.9
S	O	L	2	0	5	1	1	-	0	Grundutförande - välj hjul nr. 7, 8 eller 9	NX-AL-BN	AB-ME	CH	ST-COM	RM
-	-	-	-	-	-	-	-	7	-	$\varnothing$ 65 mm, obromsat, för matta	8 355 kr	8 850 kr	9 045 kr	9 420 kr	10 830 kr
-	-	-	-	-	-	-	-	8	-	$\varnothing$ 65 mm, bromsat, för matta					0
-	-	-	-	-	-	-	-	9	-	$\varnothing$ 65 mm, bromsat, för hårt golv					0
-	-	-	-	-	-	-	-	N	-	$\varnothing$ 65 mm, ihåligt, svart				tillägg	330 kr
-	-	-	-	-	-	-	-	C	-	$\varnothing$ 65 mm, ihåligt, krom				tillägg	375 kr

1	2	3	4	5	6	7	8	9	10						
S	O	L	2	0	5	1	2	-	0	5-fotkryss $\varnothing$ 700 mm, polerad alu				tillägg	735 kr

1	2	3	4	5	6	7	8	9							
T	R	B	R	0	3					Armstöd 2D, svart					1140 kr
B	R	E	G	T	R	0	2			Armstöd 3D, svart					1170 kr
T	R	B	R	0	5					Armstöd 4D, svart					1455 kr
T	R	B	R	E	G	0	2	0		Armstöd 4D, alu, svart top					3045 kr



# Soffio - Mesh

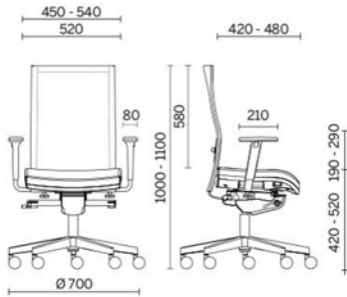

## Grundutförande:

Sits klädd, val nedan  
 Rygg i mesh RF 01 svart. Val nedan av mesh färg, ändra position 3 i artikel.nr  
 Ryggens ram/skal i PA  
 5-fotkryss  $\varnothing$  700 mm, stålförstärkt PA  
 Hjul  $\varnothing$  65 mm – val av hjul, ändra position 9 i artikel.nr

## Höjdjustering

Synkronmekanism låsbar i 5 lägen, justering av gungans hårdhet med hjälp av ett sidohandtag (vev), anti-chock-system  
 Svanstödsjustering  
 Sitsdjupsjustering

## Tillval:

Hjul  $\varnothing$  65 mm, ihåliga – val nedan, ändra position 9 i artikel.nr  
 5-fotkryss  $\varnothing$  700 mm, polerad aluminium – val nedan, ändra position 8 i artikel.nr  
 Armstöd, 2D justerbar i höjd, bredd – 3D höjd, djup, vinkel – 4D höjd, bredd, djup, vinkel (separat art.nr)

Volym:	0,232 m <sup>3</sup>
Netto vikt:	14,60 kg
Gross vikt:	17,60 kg
Förpackade:	1 krt
COM, tyngtgång sits	0,50 m – Tygbredd: 1,4 m

1 2 3 4 5 6 7 8 9 10

S O T 2 0 5 1 1 - 0

Grundutförande - välj hjul nr. 7, 8 eller 9

Pg.1	Pg.2	Pg.3	Pg.4	Pg.9
NX-AL-BN	AB-ME	CH	ST-COM	RM
6 285 kr	6 420 kr	6 465 kr	6 870 kr	7 170 kr

1 2 3 4 5 6 7 8 9 10

- - - - - 7 -  
 - - - - - 8 -  
 - - - - - 9 -  
 - - - - - N -  
 - - - - - C -

$\varnothing$ 65 mm, obromsat, för matta		0
$\varnothing$ 65 mm, bromsat, för matta		0
$\varnothing$ 65 mm, bromsat, för hårt golv		0
$\varnothing$ 65 mm, ihåligt, svart	tillägg	330 kr
$\varnothing$ 65 mm, ihåligt, krom	tillägg	375 kr

1 2 3 4 5 6 7 8 9 10

- - W - - - - -  
 - - 3 - - - - -  
 - - 4 - - - - -  
 - - 6 - - - - -

Rygg mesh, RF15, vit		0
Rygg mesh, RF02, ljusgrå		0
Rygg mesh, RF04, mellangrå		0
Rygg mesh, RF03, blå		0

1 2 3 4 5 6 7 8 9 10

S O T 2 0 5 1 2 - 0

5-fotkryss  $\varnothing$  700 mm, polerad alu

tillägg 735 kr

1 2 3 4 5 6 7 8 9

T R B R 0 3  
 B R E G T R 0 2  
 T R B R 0 5  
 T R B R E G 0 2 0

Armstöd 2D, svart		1 140 kr
Armstöd 3D, svart		1 170 kr
Armstöd 4D, svart		1 455 kr
Armstöd 4D, alu, svart top		3 045 kr

30% Rabatt skall dras av angivna priser



# Skate

design Bertolini – Ferrarese – Scagnellato

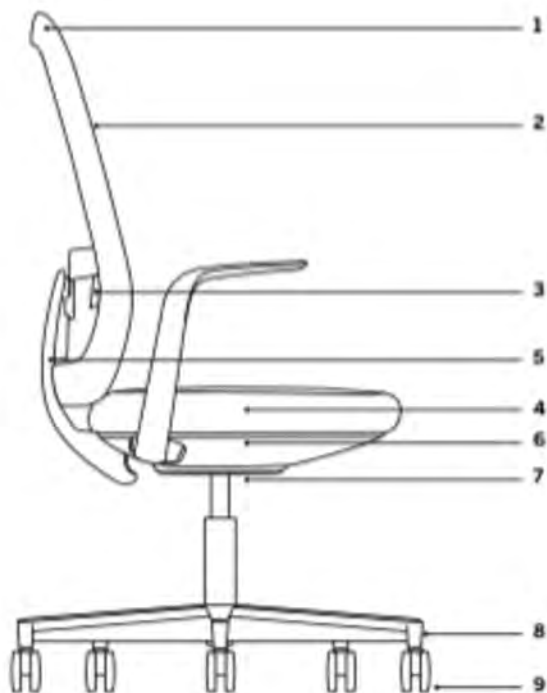

## TEKNISK SPECIFIKATION

- 1 Struktur i PA
- 2 Rygg i mesh eller tyg (plain)
- 3 Svankstödsjustering
- 4 Sits i skum
- 5/6 Sits med 3D "soft-tilt", DAT® Dynamic Adaptive Technology
- 7 Höjdjustering (360°)
- 8 Fotkryss i PA eller aluminium ø 700mm



DAT® Dynamic Adaptive Technology

Skate främjar fysiskt välbefinnande, är utformad för att stimulera rörelse även när du sitter och är utrustad med en mekanism patenterat av Sitland: DAT®.

DAT® Dynamic Adaptive Technology-systemet gör att sitsen och ryggstödet kan svänga fritt efter kroppens rörelse.

Skate-ryggstödet är inspirerad av en skateboard, den T-formade delen som förbinder hjulen till brädet och gör att den kan anpassa sig till skateboardåkarens rörelser. Precis som åkaren behöver skateboardanvändaren inte spakar och knoppar för att justera gungan, allt händer i harmoni med deras rörelser och enligt deras kroppsvikt.

30% Rabatt skall dras av angivna priser



# Skate - Mesh

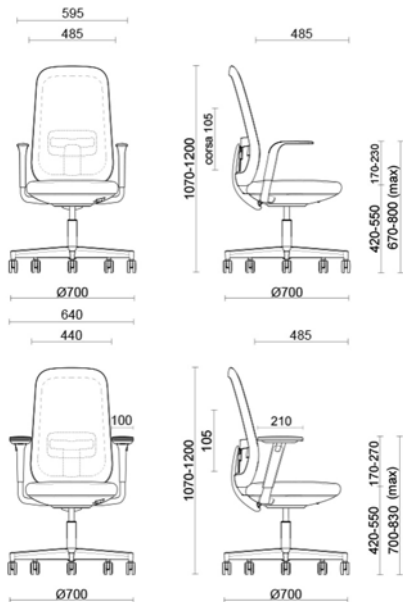

## Grundutförande:

Klädd sits  
 Rygg i mesh  
 Struktur i polyamid  
 5-fotkryss  $\varnothing$  700 mm, stålförstärkt nylon  
 Hjul  $\varnothing$  65 mm – val av hjul, ändra position 9 i artikel.nr  
 Med eller utan fast armstöd – val nedan, ändra position 6 i artikel.nr

Höjjustering  
 3D "soft-tilt" (för beskrivning av 3D-tilt, se sitland.com)

## Tillval:

Hjul  $\varnothing$  65 mm, ihåliga – val nedan, ändra position 9 i artikel.nr  
 5-fotkryss  $\varnothing$  700 mm, polerad aluminium – val nedan, ändra position 8 i artikel.nr  
 Armstöd 1D eller 3D (separat art.nr.)

Volym: 0,524 m<sup>3</sup>  
 Netto vikt: 16,60 kg  
 Gross vikt: 22,00 kg  
 Förpackade: 1 krt  
 COM, tygätgång sits 0,55 m – Tygbredd: 1,4 m

1 2 3 4 5 6 7 8 9 10

S 8 R N 0 0 1 A - 1

Svart struktur

Grundutförande - välj hjul nr. 7, 8 eller 9

Rygg mesh RR

Pg.1	Pg.2	Pg.3	Pg.4	Pg.5	Pg.9
AL-BN	AB-ME	CH	IP-AV-ST-SC	CS-SY	IS
8 760 kr	8 940 kr	9 030 kr	9 240 kr	9 585 kr	9 795 kr

1 2 3 4 5 6 7 8 9 10

S 8 R N 0 0 1 A - 1

Svart struktur

Grundutförande - välj hjul nr. 7, 8 eller 9

Rygg mesh RY

AL-BN	AB-ME	CH	IP-AV-ST-SC	CS-SY	IS
8 865 kr	9 030 kr	9 135 kr	9 300 kr	9 660 kr	9 900 kr

1 2 3 4 5 6 7 8 9 10

S 8 R B 0 0 1 B - 1

Vit struktur

Grundutförande - välj hjul nr. 7, 8 eller 9

Rygg mesh RR

Pg.1	Pg.2	Pg.3	Pg.4	Pg.5	Pg.9
AL-BN	AB-ME	CH	IP-AV-ST-SC	CS-SY	IS
9 450 kr	9 645 kr	9 750 kr	9 960 kr	10 335 kr	10 560 kr

1 2 3 4 5 6 7 8 9 10

S 8 R B 0 0 1 B - 1

Vit struktur

Grundutförande - välj hjul nr. 7, 8 eller 9

Rygg mesh RY

AL-BN	AB-ME	CH	IP-AV-ST-SC	CS-SY	IS
9 555 kr	9 750 kr	9 840 kr	10 065 kr	10 425 kr	10 665 kr

1 2 3 4 5 6 7 8 9 10

- - - - - 7 -  
 - - - - - 8 -  
 - - - - - 9 -  
 - - - - - D -  
 - - - - - F -

$\varnothing$  65 mm, obromsat, för matta

$\varnothing$  65 mm, bromsat, för matta

$\varnothing$  65 mm, bromsat, för hårt golv

$\varnothing$  65 mm, ihåligt, svart

$\varnothing$  65 mm, ihåligt, vit

0  
0  
0  
510 kr  
510 kr

1 2 3 4 5 6 7 8 9 10

- - - - - C -  
 - - - - - D -

5-fotkryss  $\varnothing$  700 mm, top i polerad alu, sidor i blank svart

5-fotkryss  $\varnothing$  700 mm, top i polerad alu, sidor i blank vit

tillägg 1035  
 tillägg 1125

- - - - - 1 -  
 - - - - - 1 -  
 - - - - - 2 -  
 - - - - - 2 -  
 - - - - - 3 -  
 - - - - - 3 -

Fast armstöd, svart

Fast armstöd, vit

1D armstöd, svart

1D armstöd, vit

3D armstöd, svart

3D armstöd, vit

tillägg 615  
 tillägg 660  
 tillägg 1245  
 tillägg 1335  
 tillägg 1365  
 tillägg 1485

30% Rabatt skall dras av angivna priser



# Skate - Tyg

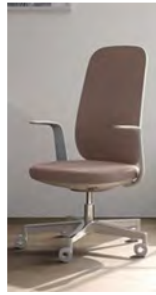
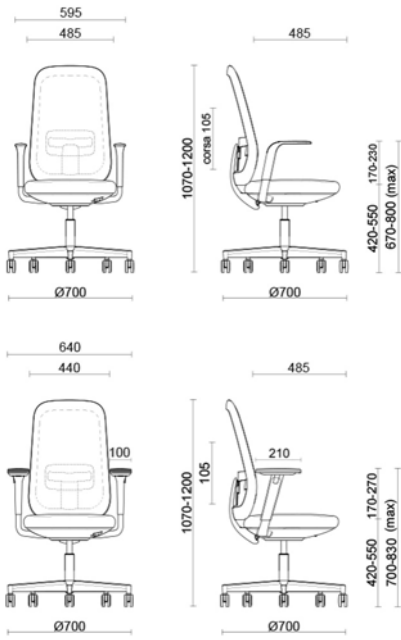

## Grundutförande:

Klädd sits  
 Rygg i tyg, utvalda tyg/färg (ej stoppad)  
 Struktur i polyamid  
 5-fotkryss  $\varnothing$  700 mm, stålförstärkt nylon  
 Hjul  $\varnothing$  65 mm – val av hjul, ändra position 9 i artikel.nr  
 Med eller utan fast armstöd – val nedan, ändra position 6 i artikel.nr

Höjdjustering  
 3D "soft-tilt" (för beskrivning av 3D-tilt, se [sitland.com](http://sitland.com))

## Tillval:

Hjul  $\varnothing$  65 mm, ihåliga – val nedan, ändra position 9 i artikel.nr  
 5-fotkryss  $\varnothing$  700 mm, polerad aluminium – val nedan, ändra position 8 i artikel.nr  
 Armstöd 1D eller 3D (separat art.nr.)

Volym: 0,524 m<sup>3</sup>  
 Netto vikt: 16,60 kg  
 Gross vikt: 22,00 kg  
 Förpackade: 1 krt  
 COM, tygätgång sits 0,55 m – Tygbredd: 1,4 m

1 2 3 4 5 6 7 8 9 10

S O L 2 0 5 1 1 - 0

Grundutförande - välj hjul nr. 7, 8 eller 9

Pg.1	Pg.2	Pg.3	Pg.4	Pg.9
NX-AL-BN	AB-ME	CH	ST-COM	RM
8 355 kr	8 850 kr	9 045 kr	9 420 kr	10 830 kr

1 2 3 4 5 6 7 8 9 10

- - - - - 7 -  
 - - - - - 8 -  
 - - - - - 9 -  
 - - - - - N -  
 - - - - - C -

$\varnothing$ 65 mm, obromsat, för matta	0
$\varnothing$ 65 mm, bromsat, för matta	0
$\varnothing$ 65 mm, bromsat, för hårt golv	0
$\varnothing$ 65 mm, ihåligt, svart	tillägg 330 kr
$\varnothing$ 65 mm, ihåligt, krom	tillägg 375 kr

1 2 3 4 5 6 7 8 9 10

S O L 2 0 5 1 2 - 0

5-fotkryss  $\varnothing$  700 mm, polerad alu

tillägg 735 kr

1 2 3 4 5 6 7 8 9

T R B R 0 3  
 B R E G T R 0 2  
 T R B R 0 5  
 T R B R E G 0 2 0

Armstöd 2D, svart	1 140 kr
Armstöd 3D, svart	1 170 kr
Armstöd 4D, svart	1 455 kr
Armstöd 4D, alu, svart top	3 045 kr





# Invicta Point

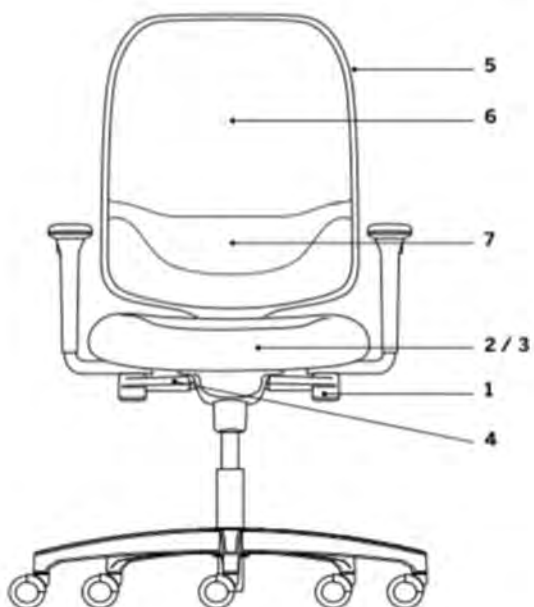

## TEKNISK SPECIFIKATION

- 1 Höjd justering
- 2 Ergonomisk sits, PU, "Comfort Air" teknologi
- 3 Inre struktur i sits, trä
- 4 Synkronmekanism, gunga med hårdhetsjustering och låsbar i 4 positioner, anti-chock system
- 5 Rygg struktur i PA
- 6 Rygg, mesh
- 7 Svankstödsjustering

## ÖVERDRAG TILL SITS

För att anpassa stolen Invicta Point eller för att ändra dess utseende finns ett överdrag i tyg IP (sidor i svart IP01-tyg).  
Överdraget är enkelt att installera, det kan bytas ut och tvättas separat.



# Invicta Point

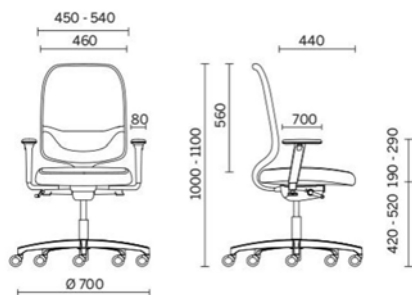

## Grundutförande:

Klädd sits, val nedan  
 Rygg i mesh, val nedan  
 5-fotkryss  $\varnothing$  700 mm, stålförstärkt PA  
 Hjul  $\varnothing$  65 mm – val av hjul, ändra position 10 i artikel.nr

Höjdjustering  
 Synkronmekanism låsbar i 4 positioner, justering av gungans hårdhet med hjälp av ett sidohandtag (vev), anti-chock-system  
 Svankstödsjustering  
 Sitsdjupsjustering

## Tillval:

Hjul  $\varnothing$  65 mm, ihåliga – val nedan, ändra position 10 i artikel.nr  
 5-fotkryss  $\varnothing$  700 mm, polerad aluminium – val nedan, ändra position 9 i artikel.nr  
 Version i ljusgrått – val nedan, ändra position 5 och 9 i artikel.nr  
 Armstöd, 2D justerbar i höjd, bredd – 4D höjd, bredd, djup, vinkel (separat art.nr)

Volym: 0,206 m<sup>3</sup>  
 Netto vikt: 12,00 kg  
 Gross vikt: 14,00 kg  
 Förpackade: 1 krt  
 COM, tygätgång sits 0,50 m – Tygbredd: 1,4 m

1 2 3 4 5 6 7 8 9 10

I V P 0 0 0 B 0 1 - Grundutförande - välj hjul nr. 7, 8 eller 9

1 2 3 4 5 6 7 8 9 10

I V P 0 0 0 B 0 1 - Grundutförande - välj hjul nr. 7, 8 eller 9

	Pg.1	Pg.2	Pg.3	Pg.4
Rygg mesh RP, RR	AL-BN	AB-ME	CH-RR	ST-SC-COM
	5 715 kr	5 925 kr	6 045 kr	6 315 kr
Rygg mesh RY	AL-BN	AB-ME	CH-RR	ST-SC-COM
	5 895 kr	6 060 kr	6 195 kr	6 480 kr

1 2 3 4 5 6 7 8 9 10

-	-	-	-	-	-	-	-	-	7	-	$\varnothing$ 65 mm, obromsat, för matta	0
-	-	-	-	-	-	-	-	-	8	-	$\varnothing$ 65 mm, bromsat, för matta	0
-	-	-	-	-	-	-	-	-	9	-	$\varnothing$ 65 mm, bromsat, för hårt golv	0
-	-	-	-	-	-	-	-	-	N	-	$\varnothing$ 65 mm, ihåligt, svart	tillägg 330 kr
-	-	-	-	-	-	-	-	-	C	-	$\varnothing$ 65 mm, ihåligt, krom	tillägg 375 kr

1 2 3 4 5 6 7 8 9 10

I	V	P	0	0	0	B	0	4	-	5-fotkryss $\varnothing$ 700 mm, polerad alu	tillägg 825
I	V	P	0	G	0	B	0	2	-	Version i ljusgrått, 5-fotkryss i stålförstärkt nylon	tillägg 510
I	V	P	0	G	0	B	0	4	-	Version i ljusgrått, 5-fotkryss i polerad alu	tillägg 1335

1 2 3 4 5 6 7 8 9 10

I	V	P	B	R	K	I	T	0	3	Armstöd 2D, svart	1275 kr
I	V	P	B	R	K	I	T	0	5	Armstöd 4D, svart	1545 kr
I	V	P	B	R	K	I	T	0	G	Armstöd 4D, ljusgrå, svart top	1770 kr



# Invicta Point Pit Stop

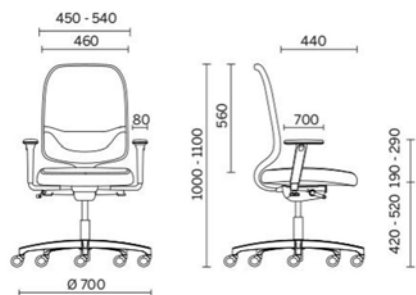

## Utförande:

Sits klädd, BN01, svart  
Rygg i mesh RP10, svart  
5-fotkryss  $\varnothing$  700 mm, stålförstärkt PA  
Hjul  $\varnothing$  50 mm, bromsat för matta  
Hjul för hårt golv (gummibana) beställs separat, eget art.nr

## Höjjustering

Synkroniseringsmekanism låsbar i 4 lägen för justering av rygg- och sitsvinkel, justering av gungans hårdhet med hjälp av ett sidohandtag (vev), anti-chock-system  
Svankstödsjustering  
Armstöd 1D (höj/sänk)

Inga val kan göras - snabblager stol



Volym:	0,206 m <sup>3</sup>
Netto vikt:	14,40 kg
Gross vikt:	16,40 kg
Förpackade:	1 krt

1 2 3 4 5 6 7 8 9 10

I V P 0 0 0 A D 7 3 BN01 RP10

5 295 kr

1 2 3 4 5 6 7 8 9 10

I V P K I T R 5 0 0 Hjul  $\varnothing$  50 mm, bromsat för hårt golv (gummibana)

315 kr



# Invicta Comfort

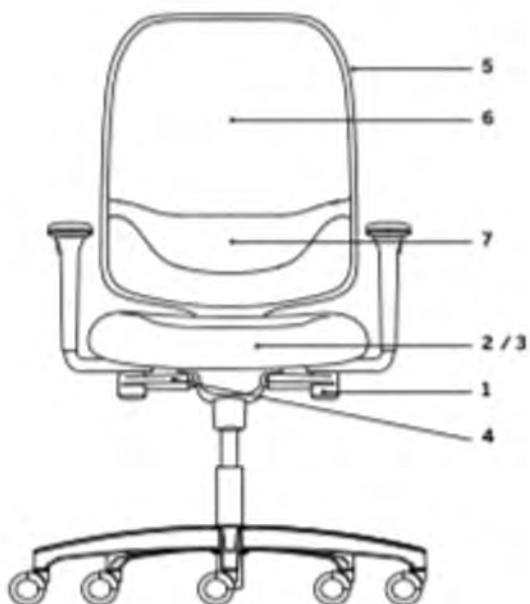

## TEKNISK SPECIFIKATION

- 1 Höjd justering
- 2 Ergonomisk sits, PU, "Comfort Air" teknologi
- 3 Inre struktur i sits, trä
- 4 Kontaktmekanism, gunga med hårdhetsjustering och låsbar i 4 positioner, anti-chock system
- 5 Rygg struktur i PA
- 6 Rygg, mesh
- 7 Svankstödsjustering



# Invicta Comfort

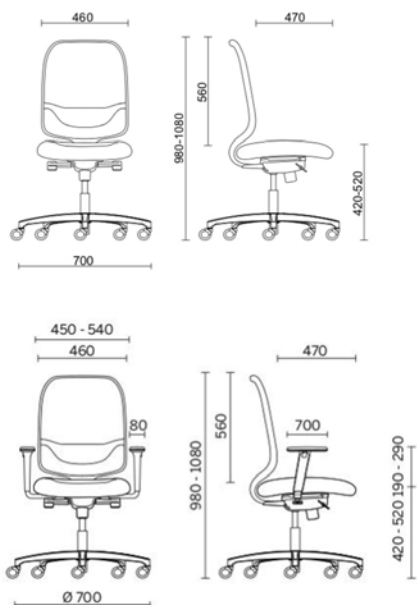

## Grundutförande:

Klädd sits, val nedan  
 Rygg i mesh, val nedan  
 5-fotkryss  $\varnothing$  700 mm, stålförstärkt PA  
 Hjul  $\varnothing$  50 mm – val av hjul, ändra position 10 i artikel.nr

Höjdjustering  
 Synkronmekanism låsbar i 4 positioner, justering av gungans hårdhet med hjälp av en ratt, anti-chock-system  
 Svankstödsjustering

## Tillval:

5-fotkryss  $\varnothing$  700 mm, polerad aluminium – val nedan, ändra position 9 i artikel.nr  
 Version i ljusgrått – val nedan, ändra position 5 och 9 i artikel.nr  
 Armstöd, 2D justerbar i höjd, bredd – 4D höjd, bredd, djup, vinkel (separat art.nr)

Volym: 0,206 m<sup>3</sup>  
 Netto vikt: 11,30 / 13,50 kg  
 Gross vikt: 13,70 / 15,90 kg  
 Förpackade: 1 krt  
 COM, tygätgång sits 0,50 m – Tygbredd: 1,4 m

1	2	3	4	5	6	7	8	9	10		Pg.1	Pg.2	Pg.3	Pg.4
I	V	P	0	0	3	F	0	1	-	Grundutförande - välj hjul nr. 3 eller 5	4 200 kr	4 365 kr	4 410 kr	4 455 kr

1	2	3	4	5	6	7	8	9	10		AL-BN	AB-ME	CH	ST-SC-COM
I	V	P	0	0	3	F	2	1	-	Grundutförande - välj hjul nr. 3 eller 5 monterade armstöd 2D, svart (gäller endast version i svart)	5 295 kr	5 400 kr	5 460 kr	5 535 kr

1	2	3	4	5	6	7	8	9	10					
-	-	-	-	-	-	-	-	3	-	$\varnothing$ 50 mm, bromsat, för matta				0
-	-	-	-	-	-	-	-	5	-	$\varnothing$ 50 mm, bromsat, för hårt golv				0

1	2	3	4	5	6	7	8	9	10					
I	V	P	0	0	3	F	0	4	-	5-fotkryss $\varnothing$ 700 mm, polerad alu			tillägg	825
I	V	P	0	G	3	F	0	2	-	Version i ljusgrått, 5-fotkryss i stålförstärkt nylon			tillägg	510
I	V	P	0	G	3	F	0	4	-	Version i ljusgrått, 5-fotkryss i polerad alu			tillägg	1335

1	2	3	4	5	6	7	8	9	10					
I	V	C	B	R	K	I	T	2	3	Armstöd 2D, svart				1275 kr
I	V	C	B	R	K	I	T	2	5	Armstöd 4D, svart				1545 kr
I	V	C	B	R	K	I	T	2	G	Armstöd 4D, ljusgrå, svart top				1770 kr



# No Name

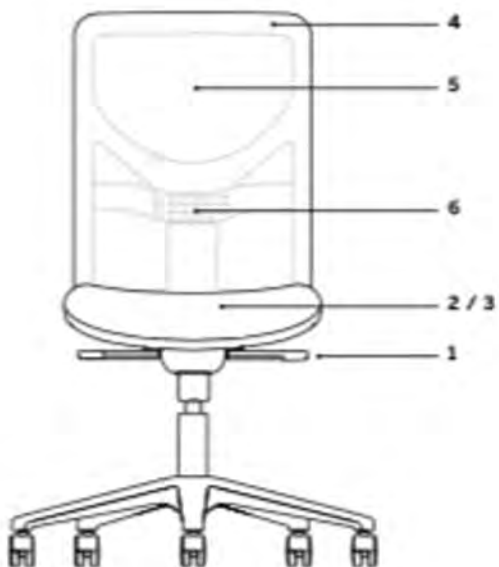

## TEKNISK SPECIFIKATION

- 1 Höjd justering
- 2 Ergonomisk sits, PU, hög densitet
- 3 Inre struktur sits, trä
- 4 Rygg struktur i PA
- 5 Rygg i mesh
- 6 Svankstödsjustering



# No Name

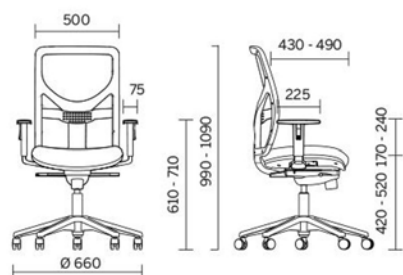
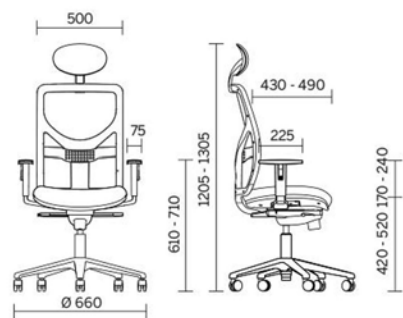

## Grundutförande:

Sits klädd, val nedan  
 Rygg i mesh, val nedan  
 5-fotkryss  $\varnothing$  660 mm, stålförstärkt PA  
 Hjul  $\varnothing$  50 mm – val av hjul, ändra position 9 i artikel.nr

Höjdjustering  
 Synkronmekanism låsbar i 4 lägen, justering av gungans hårdhet med hjälp av ett handtag, anti-chock-system  
 Rygg, justerbar i höjd  
 Sitsdjupjustering  
 Armstöd 1D, justerbart i höjd

## Tillval:

Nackstöd, justerbart i höjd – val nedan, ändra position 3 i artikel.nr  
 5-fotkryss  $\varnothing$  660 mm, polerad aluminium – val nedan, ändra position 8 i artikel.nr  
 Armstöd 2D, justerbart i höjd, bredd – val nedan, ändra position 7 i artikel.nr

Volym: 0,206 m<sup>3</sup>  
 Netto vikt: 12,10 - 14,30 kg  
 Gross vikt: 14,30 - 16,50 kg  
 Förpackade: 1 krt  
 COM, tygåtgång sits 0,50 m – Tygbredd: 1,4 m  
 COM, tygåtgång sits+nackstöd 0,60 m – Tygbredd: 1,4 m

1 2 3 4 5 6 7 8 9 10

N N O 1 0 B 4 A - 0 Grundutförande - välj hjul nr.2, 3 eller 5

Rygg, mesh  
RR

Pg. 1  
BN

Pg. 2  
AB

5 250 kr

5 385 kr

1 2 3 4 5 6 7 8 9 10

N N O 1 0 B 4 A - 0 Grundutförande - välj hjul nr.2, 3 eller 5

Rygg, mesh  
RY

BN

AB

5 385 kr

5 520 kr

1 2 3 4 5 6 7 8 9 10

- - - - - 2 -  $\varnothing$  50 mm, obromsat, för matta 0  
 - - - - - 3 -  $\varnothing$  50 mm, bromsat, för matta 0  
 - - - - - 5 -  $\varnothing$  50 mm, bromsat, för hårt golv 0

1 2 3 4 5 6 7 8 9 10

- - - - - 4 - 5-fotkryss  $\varnothing$  660 mm, polerad alu

tillägg

735 kr

1 2 3 4 5 6 7 8 9 10

- - D - - - - - Nackstöd - ändra position 3

tillägg

645 kr

1 2 3 4 5 6 7 8 9 10

- - - - - 2 - Armstöd 2D, svart

tillägg

645 kr



# Classic



## TEKNISK SPECIFIKATION

- 1 Sits och rygg, PU (skum)
- 2 Inre struktur i stål
- 3 Ram struktur i stål, "kromfinish"
- 4 Fast karm





# Classic Executive

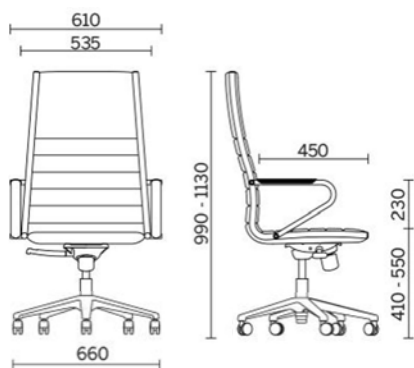

## Grundutförande:

Hög rygg  
 Ram, krom eller svart – val nedan  
 Fast karm  
 Sits/rygg i PU, CFC-fri  
 5 fotkryss polerad aluminium eller svart (rakt) – val nedan  
 Hjul ø 65 mm – val av hjul, ändra position 9 i artikel.nr

Höjdjustering  
 Tiltmekanism, låsbar i upprätt läge, justerbar hårdhet av gunga/tilt.

## Tillval:

Hjul ø 65 mm, ihåliga – val nedan, ändra position 9 i artikel.nr  
 Fast karm, med klädd "top", tyg eller skinn - val nedan, ändra position 7 i artikel.nr  
 Tiltmekanism, knägunga, låsbar i 4 lägen - val nedan, ändra position 6 i artikel.nr

Volym: 0,328 m3  
 Netto vikt: 16,00 kg  
 Gross vikt: 19,00 kg  
 Förpackade: 1 krt  
 COM, tygätgång 1,70 m – Tygbredd: 1,4 m

1	2	3	4	5	6	7	8	9	10	Pg.1	Pg.2	Pg.3	Pg.4	Pg.5	Pg.9	Pg.A	Pg.E	Pg.C
C	S	D	A	0	1	1	-	-	1	NX	ME	CH	MF-SC-COM	CS-SY	RM	SX+NX	PA	TS
Grundutförande - välj hjul nr. 7, 8 eller 9										9 660 kr	9 945 kr	10 560 kr	10 845 kr	11 865 kr	12 075 kr	10 920 kr	12 240 kr	15 780 kr

-	-	-	-	-	-	-	-	-	D	-	-	Krom ram och alu. Fotkryss						0
-	-	-	-	-	-	-	-	-	E	-	-	Svart ram och fotkryss						0

-	-	-	-	-	-	-	-	-	7	-	ø 65 mm, obromsat, för matta						0
-	-	-	-	-	-	-	-	-	8	-	ø 65 mm, bromsat, för matta						0
-	-	-	-	-	-	-	-	-	9	-	ø 65 mm, bromsat, för hårt golv						0
-	-	-	-	-	-	-	-	-	N	-	ø 65 mm, ihåligt, svart						tillägg 480 kr
-	-	-	-	-	-	-	-	-	C	-	ø 65 mm, ihåligt, krom						tillägg 555 kr

1	2	3	4	5	6	7	8	9	10	Pg.1	Pg.2	Pg.3	Pg.4	Pg.5	Pg.9	Pg.A	Pg.E	Pg.C
-	-	-	-	-	-	3	-	-	-	NX	ME	CH	IP-AV-SC	CS-SY	RM	SX+NX	PA	TS
Klädd karm i samma tyg som stolen										tillägg 480 kr	495 kr	510 kr	525 kr	585 kr	615 kr	825 kr	840 kr	1020 kr
Klädd karm i "SX" läder, valfri färg										tillägg -	1575 kr	1575 kr	1575 kr	1575 kr	1575 kr	-	-	-

-	-	-	-	-	4	-	-	-	-	Knäledsgunga								tillägg 720 kr
---	---	---	---	---	---	---	---	---	---	--------------	--	--	--	--	--	--	--	----------------



# Classic Manager

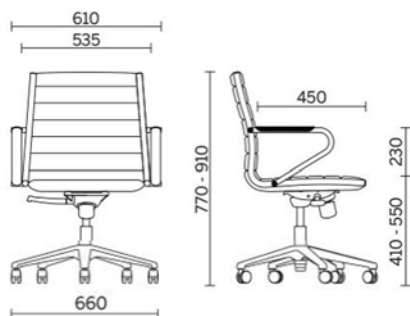

## Grundutförande:

Låg rygg  
 Ram, krom eller svart – val nedan  
 Fast karm  
 Sits/rygg i PU, CFC-fri  
 5 fotkryss polerad aluminium eller svart (rakt) – val nedan  
 Hjul ø 65 mm – val av hjul, ändra position 9 i artikel.nr

Höjdjustering  
 Tiltmekanism, låsbar i upprätt läge, justerbar hårdhet av gunga/tilt.

## Tillval:

Fast karm, med klädd "top", tyg eller skinn - val nedan, ändra position 7 i artikel.nr  
 Hjul ø 65 mm, ihåliga – val nedan, ändra position 9 i artikel.nr

Volym: 0,313 m3  
 Netto vikt: 15,20 kg  
 Gross vikt: 17,80 kg  
 Förpackade: 1 krt  
 COM, tygätgång 1,40 m – Tygbredd: 1,4 m

1 2 3 4 5 6 7 8 9 10

C S O A 0 1 1 - - 1

Grundutförande - välj hjul nr. 7, 8 eller 9

Pg.1	Pg.2	Pg.3	Pg.4	Pg.5	Pg.9	Pg.A	Pg.E	Pg.C
NX	ME	CH	MF-SC-COM	CS-SY	RM	SX+NX	PA	TS
8 805 kr	9 150 kr	9 525 kr	9 825 kr	11 130 kr	11 340 kr	10 545 kr	11 265 kr	13 845 kr

- - - - - D - -  
 - - - - - E - -

Krom ram och alu.  
 Fotkryss  
 Svart ram och fotkryss

0  
 0

1 2 3 4 5 6 7 8 9 10

- - - - - 7 -  
 - - - - - 8 -  
 - - - - - 9 -  
 - - - - - N -  
 - - - - - C -

ø 65 mm, obromsat, för matta  
 ø 65 mm, bromsat, för matta  
 ø 65 mm, bromsat, för hårt golv  
 ø 65 mm, ihåligt, svart  
 ø 65 mm, ihåligt, krom

0  
 0  
 0  
 tillägg 480 kr  
 tillägg 555 kr

1 2 3 4 5 6 7 8 9 10

- - - - - 3 - - -  
 - - - - - 5 - - -

Klädd karm i samma tyg som stolen  
 Klädd karm i "SX" läder, valfri färg

tillägg  
 tillägg

Pg.1	Pg.2	Pg.3	Pg.4	Pg.5	Pg.9	Pg.A	Pg.E	Pg.C
NX	ME	CH	MF-SC-COM	CS-SY	RM	SX+NX	PA	TS
480 kr	495 kr	510 kr	525 kr	585 kr	615 kr	825 kr	840 kr	1 020 kr
-	1 575 kr	1 575 kr	1 575 kr	1 575 kr	1 575 kr	-	-	-



# Classic Meeting

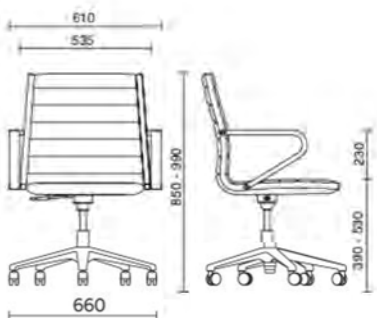
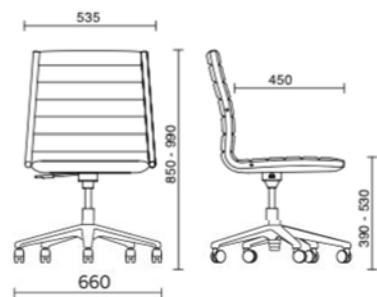

## Grundutförande:

Låg rygg  
 Ram, krom eller svart – val nedan  
 Sits/rygg i PU, CFC-fri  
 5 fotkryss polerad aluminium eller svart (rakt) – val nedan  
 Hjul ø 65 mm – val av hjul, ändra position 9 i artikel.nr

## Höjjustering

## Tillval:

Fast karm (oklädd)  
 Fast karm, med klädd "top", tyg eller skinn - val nedan, ändra position 7 i artikel.nr  
 Hjul ø 65 mm, ihåliga – val nedan, ändra position 9 i artikel.nr  
 3D "soft-tilt" - val nedan, ändra position 6 i artikel.nr

Volym: 0,313 m3  
 Netto vikt: 11,00 kg  
 Gross vikt: 14,00 kg  
 Förpackade: 1 krt  
 COM, tygätgång 1,40 m – Tygbredd: 1,4 m

	Pg.1	Pg.2	Pg.3	Pg.4	Pg.5	Pg.9	Pg.A	Pg.E	Pg.C
1 2 3 4 5 6 7 8 9 10	NX	ME	CH	MF-SC-COM	CS-SY	RM	SX+NX	PA	TS
C S M A 0 2 0 - - 1	6 900 kr	7 200 kr	7 605 kr	7 905 kr	9 120 kr	9 330 kr	8 430 kr	9 165 kr	11 925 kr

Grundutförande - välj hjul nr. 7, 8 eller 9

- - - - - D - -	Krom ram och alu. Fotkryss	0
- - - - - E - -	Svart ram och fotkryss	0

1	2	3	4	5	6	7	8	9	10		
-	-	-	-	-	-	-	-	6	-	glidfötter	0
-	-	-	-	-	-	-	-	7	-	ø 65 mm, obromsat, för matta	0
-	-	-	-	-	-	-	-	8	-	ø 65 mm, bromsat, för matta	0
-	-	-	-	-	-	-	-	9	-	ø 65 mm, bromsat, för hårt golv	0
-	-	-	-	-	-	-	-	N	-	ø 65 mm, ihåligt, svart	tillägg 480 kr
-	-	-	-	-	-	-	-	C	-	ø 65 mm, ihåligt, krom	tillägg 555 kr

1	2	3	4	5	6	7	8	9	10		
-	-	-	-	-	-	1	-	-	-	Karm / Armstöd (oklädd)	tillägg 1 875 kr

	Pg.1	Pg.2	Pg.3	Pg.4	Pg.5	Pg.9	Pg.A	Pg.E	Pg.C
1 2 3 4 5 6 7 8 9 10	NX	ME	CH	MF-SC-COM	CS-SY	RM	SX+NX	PA	TS
- - - - - 3 - - -	2 355 kr	2 370 kr	2 385 kr	2 400 kr	2 460 kr	2 490 kr	2 700 kr	2 715 kr	2 895 kr
- - - - - 5 - - -	-	3 240 kr	3 240 kr	3 240 kr	3 240 kr	3 240 kr	-	-	-

- - - - - C - - - -	3D "soft-tilt"	tillägg 1 830 kr
---------------------	----------------	------------------

30% Rabatt skall dras av angivna priser



# Classic Visitor

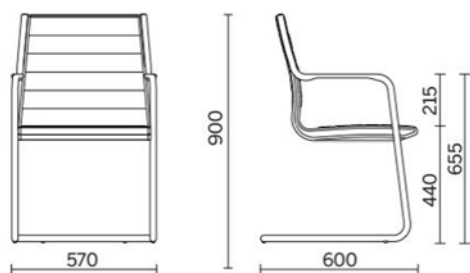

## Grundutförande:

Låg rygg  
Medstativ, krom eller svart – val nedan (position 8)  
Sits/rygg i PU, CFC-fri

Volym: 0,379 m<sup>3</sup>  
Netto vikt: 11,00 kg  
Gross vikt: 13,80 kg  
Förpackade: 1 krt  
COM, tygätgång 1,30 m – Tygbredd: 1,4 m

1 2 3 4 5 6 7 8 9 10

J L V A 0 1 0 D 0 0

**Classic - visitor, medstativ, krom**

J L V A 0 1 0 E 0 0

**Classic - visitor, medstativ, svart**

Pg.1	Pg.2	Pg.3	Pg.4	Pg.5	Pg.9	Pg.A	Pg.E	Pg.C
NX	ME	CH	MF-SC-COM	CS-SY	RM	SX+NX	PA	TS
6 510 kr	6 825 kr	7 170 kr	7 590 kr	8 820 kr	9 030 kr	8 145 kr	9 270 kr	11 940 kr
6 510 kr	6 825 kr	7 170 kr	7 590 kr	8 820 kr	9 030 kr	8 145 kr	9 270 kr	11 940 kr



# Använda prislistan

## 1. Product code composition

The product codes are made of a matrix (10 digits for the chair) followed by the upholstery references.

Product code										Upholstery code							
1	2	3	4	5	6	7	8	9	10	11	12	13	14	15	16	17	18
M	I	A	O	7	D	C	1	8	2								

For a correct order, please verify the code of reference and the variation that may occur in the price.

NOTE: for products with upholstery cat. "A", (real leather cat. SX on the parts which are in contact with the user, combined with ecological leather cat. NX for the rear and side parts), it is necessary to indicate the code for the real leather first, and then the code of the matching colour for the ecological leather. For your convenience, the two upholsteries have the same colour codes.

E.g. Grace manager upholstered in real leather cat. SX combined with ecological leather cat. NX

Product code										Upholstery code							
1	2	3	4	5	6	7	8	9	10	11	12	13	14	15	16	17	18
G	A	M	O	O	B	O	7	O	6	S	X	O	1	N	X	O	1

In the case of products with two-tone upholstery, the first 4 characters of the upholstery code (from 11 to 14) refer to the colour of the seat while the last 4 characters (from 15 to 18) refer to the colour of the backrest or the shell.

E.g. Milos Life with two-tone upholstery

Product code										Front colour				Back colour			
1	2	3	4	5	6	7	8	9	10	11	12	13	14	15	16	17	18
M	I	A	A	O	A	A	2	O	O	M	E	O	1	M	E	O	4

E.g. Cell128 with two-tone upholstery

Product code										Colour seat				Body colour			
1	2	3	4	5	6	7	8	9	10	11	12	13	14	15	16	17	18
C	E	1	A	O	O	O	O	O	1	M	E	O	1	M	E	O	4

E.g. Milos Life with protruding arms

Product code									
1	2	3	4	5	6	7	8	9	10
M	I	A	A	7	-	C	1	8	2

Product code									
1	2	3	4	5	6	7	8	9	10
M	I	A	A	7	D	C	1	8	2

To select an option, please replace the "-" symbol with the character corresponding to the selected option.

## 2. Materials

Sitland uses high quality materials combined with advanced manufacturing processes.

The plastic materials are carefully selected, as well as the steel used for the production of the cantilever chairs: high resistant special steel, which allows the chairs to be light and at the same time very strong. A special attention is given to the chrome and painting processes with epoxy powders, ensuring an extremely high level, long lasting in time, proof of Sitland's quality.

The aluminium is polished, to emphasize its natural aesthetic qualities.



### 3. Upholstery vademecum

Category	Code	Name	Manufacturer	Material composition	Characteristics of the material
1	AL	Alba	FIDIVI	100% PL 100.000 Martindale	
	BN	Bondai	FIDIVI	100% PL 150.000 Martindale	
	NX			91% PVC, 9% PL 60.000 Martindale	
2	ME	Medley	Gabriel	100% PL 75.000 Martindale	
	AB	Xtreme Plus	Camira	100% post-consumer recycled PL 100.000 Martindale	
	RF	Polo	FIDIVI Service	100% PL 100.000 Martindale	
3	CH	CHill	Gabriel	100% PL Fr riciclato post-consumo, 60.000 Martindale	
	RR	Runner	Gabriel	100% PL 70.000 Martindale	
	RP	Net Medium	Serge Ferrari	70% PVC, 30% PL 100.000 Martindale	
4	RY	Rhythm	Gabriel	100% PL Fr 100.000 Martindale	
	ST	Step	Gabriel	100% PL riciclato post-consumo 100.000 Martindale	
	SC	Secret	Flukoo	76% PVC, 2% PU, 22% PES 60.000 Martindale	
	RG	Regent	Camira	100% PL Fr 50.000 Martindale	
	ME	Main Line Flax	Camira	75% Virgin Wool, 25% Flax 50.000 Martindale	
	MW	Main Line Telsi	Camira	75% Virgin Wool, 25% Flax 50.000 Martindale	
5	CS	Crisp	Gabriel	93% W della Nuova Zelanda, 7% PA 200.000 Martindale	
	SY	Synergy	Camira	95% WV, 5% PA 100.000 Martindale	
	FT	Foster	Vascom	97% recycled polyester FR / 3% polyester FR 60.000 Martindale	
	WI	Wilson	Vascom	100% PL Fr riciclato 80.000 Martindale	
	IR	Iron	FIDIVI Service	100% PL 100.000 Martindale	
	YD	Yoredale	Camira	95% W, 3% PL, 2% PA 50.000 Martindale	
9	RM	Remix 3	90% new wool, worsted 10% nylon 100.000 Martindale		
10	RW	Re-Wool	45% recycled wool 45% new wool, worsted 10% nylon 100.000 Martindale		
	HE	Hero 2	97% new wool 3% recycled nylon 45.000 Martindale		
11	FD	Fjord 3	92% new wool, worsted 8% nylon 60.000 Martindale		
	S1	Sleatcol 3	90% new wool, worsted 10% nylon 100.000 Martindale		
	SE	Sleatcol Trio 3	90% new wool, worsted 10% nylon 100.000 Martindale		
	S4	Sleatcol Quartel	90% new wool, worsted 10% nylon 100.000 Martindale		



Category	Code	Name	Manufacturer	Material composition	Characteristics of the material
A	SX + NX	SX + NX			
B	SX	Box Land	Dani		
E	PA	Panama	Dani		
C	TS	Florida	Dani		
D	TU/ TX	TU/ TX	Mastrolio		

Symbol	Description
	No heavy metals
	EU Ecolabel is a European brand that certifies the reduced environmental impact of the product
	Modified polyester fiber "Permanent Flame Retardant": capable of preserving the flame retardant properties of the fiber with aging, wear and washing. Fabrics made with Trevira CS fiber pass the most severe reaction to fire tests worldwide, reaching the best classification everywhere (Class 1 in Italy)
	GREENGUARD Certification is a European brand that certifies the low level of chemical emissions
	The Deko-Tex® STANDARD 100 label guarantees that every component of the article, has been tested for harmful substances and that the article therefore is harmless in human ecological terms
	Inhibits bacteria growth and odor development, built-in durable protection thanks to the Sanitized® hygiene function
	Der blaue Engel (RAL UZ 148) it sets stricter limits for dangerous substance content, the emission of pollutants and the use of raw materials and water than those indicated by law
	Leather from Italy full cycle (UNI EN 16484) certifies that all the production processes are carried out in Italy
	Carbon footprint of product (ISO 14067: 2018) quantifies the greenhouse gas emissions along the supply chain, from farming and rearing to realization of the finished leather
	Environmental product declaration & process EPD (ISO 14025) Following the LCA (Life Cycle Assessment) study, the following impact categories are estimated: greenhouse effect, reduction in the ozone layer, acidification, photochemical smog, eutrophication
	Real leather
	Flame retardant
	Recyclable
	Recycled
PA	Polyamide
PL	Polyester
PL F1	Flame retardant polyester
Tr Cs	Trevira CS
W	Wool
WV	Virgin Wool



# Certifikat

The following table shows the certifications obtained for each collection. To find out about the tests carried out, any requests or to request certifications, please contact our Customer Service at the email address [service@sitland.com](mailto:service@sitland.com)

	1IM	UNI EN 1335	UNI EN 1728	UNI EN 1022	UNI EN 16139	ANSI- BIFMA X5.1-2011	D.Jus. 81/2008	GREENGUARD	GREENGUARD GOLD	UNI EN ISO 354:2003
1 Mas	■	■					■			
Be Quadra		■					■			
Classic	■	■								
Cell 128	■									■
Cell 72	■									
Cell 75	■									
Fresh		■					■	■		
Fresh Air							■	■	■	
Green's	■		■	■	■			■		
Invicta Comfort	■	■					■			
Invicta Point	■	■					■	■	■	
Invicta Balance	■	■					■			
Joy	■									
Leaf		■					■	■		
Leaf Air								■		
Mesh Line	■	■					■			
Mikado			■			■				
Milos Elle	■				■					
Milos Life	■				■					
No Name	■	■					■			
Of Course		■								
On	■									
Passe- Partout	■		■	■	■			■		
Pk	■							■		
Skate		■					■			
Soffio		■					■			
Soul	■				■			■		
Soul Air	■				■			■	■	
Spirit		■					■	■		
Spirit Air		■					■	■	■	
Team Strike Evo	■	■					■			
Team Strike	■	■					■			
Team Work	■	■					■			
Uni	■			■	■					
Unimesh	■				■					
Vega Hit		■								
Vega		■								





### Certification Class 1IM

Class 1IM is the highest flame-retardant class and it is assigned according to the UNI 9175:2008 and UNI 9175/FA1:2008 standards, which define the flame-retardant characteristics of padded furniture subjected to the action of a small flame. For padded furniture the classification is based on 3 values: 1 IM (the highest class), 2 IM or 3 IM. The test is carried out by applying a 40mm flame to a prototype and carrying out several tests with different application times: 20s only on the padding, 20s on the finished article, 80s on the finished article, 140s on the finished article. At the end of the application time, the torch is removed, which generates the ignition flame, and it is checked whether or not the flame on the material extinguishes itself within 120s. Depending on the duration of the application of the flame, and if it is self-extinguishing within 120s, the Class 1IM (passed 140s test) or Class 2IM (passed 80s test) is assigned.

MILOS ELLE - MILOS - CELL128 - CELL72 - CELL75 - JOY - ON are available in the version homologated in Class 1IM with flame retardant fabric covering category ME. SOUL is available in the homologated version in Class 1IM with flame retardant mesh covering category RY. PK is available in the Class 1IM (according to the Italian law) homologated version with seat upholstery in category AB fabric and backrest net in category RY. GREEN'S is available in the Class 1IM (according to the Italian law) approved version with classic seat with category AB fabric upholstery. CLASSIC is available in the homologated version in Class 1IM (according to the Italian law) with flame retardant eco-leather upholstery category SC. TEAM STRIKE - MESH LINE - INVICTA POINT - INVICTA BALANCE - UNIMESH are available in the version approved in Class 1IM (according to the Italian law) with the upholstered seat with category AB fabric cover combined with the RY category mesh backrest. NO NAME is available in the homologated version in Class 1IM (according to the Italian law) with upholstered seat with category BN upholstery combined with the RY category mesh backrest. 1 MAS is available in the homologated version in Class 1IM (according to the Italian law) with seat and backrest covered in category BN fabric. BE-QUADRA - Team Work are available in an approved version in Class 1IM (according to the Italian law) with seat and backrest upholstered in category AB fabric. UNI is available in the homologated version in Class 1IM (according to the Italian law) approval with seat and backrest upholstered in category AB fabric. MIKADO is available in the homologated version in Class 1IM (according to the Italian law) approval is available for the seat upholstery in category AB fabric.

To obtain the prices of the products approved in Class 1IM (according to the Italian law), 10% must be added to the price of the seats with upholstery in the indicated fabric. For information and quotes, contact the Customer Service at [service@sitland.com](mailto:service@sitland.com)

### Standard EN 1335

UNI EN 1335-1:2000 - Dimensions - Determination of dimensions. The standard applies to office chairs. The standard specifies both the dimensions of three types of chairs and the test methods for determining these dimensions.

Type A - most restrictive dimensional requirements compared to the others, allows the anthropometric dimensions of the 5th and 95th percentile of people. Fully complies with Legislative Decree 81/08.

Type B - intermediate dimensional requirements, complies with smaller anthropometric percentiles, sufficient to cover the minimum functions required by Legislative Decree no. 81/08.

Type C - minimal functions, typical of directional armchairs with basic mechanisms, rather than swivel guest chairs. Does not comply with the requirements of Legislative Decree no. 81/08.

UNI EN 1335-2:2009 - Safety requirements - The standard specifies the mechanical safety requirements of office work chairs.

UNI EN 1335-3:2009 - Test methods - The standard specifies the test methods for testing the stability, resistance and durability of office work chairs.

### Standard UNI EN 1022

The standard specifies the test methods for determining the stability of all types of seating for adults up to 110 kg in weight, regardless of the type of use, materials, design/construction or production process.

The test methods described in this document may also be applied to seating for children and for adults weighing more than 110 kg by modifying the test loads and load application points.

### Standard UNI EN 16139

The standard specifies the requirements for the safety, resistance and durability of all types of non-domestic seating for adults intended for use by adults weighing less than 110 kg, including office chairs for visitors. The standard does not apply to bar seating, office chairs, chairs for educational institutions, outdoor seating, combinations of connected seats for which there are draft standards or European standards. The standard also does not apply to work chairs for industrial use. The European standard does not include requirements for resistance to ageing, deterioration and flammability.

### Legislative Decree 81/2008

Following the publication by the Official Journal No. 101 of Legislative Decree No. 81 of 9 April 2008, "Implementation of Article 1 of Law No. 123 of 3 August 2007, on the protection of health and safety in the workplace", the reference Decree for workstations equipped with video terminals officially enters into force. This decree has effectively replaced and repealed the reference technical decree, in force up to that moment, that is, Legislative Decree 626/1994.

### Greenguard and Greenguard Gold

GreenGuard and GreenGuard Gold certifications, issued by the American UL Environment Institute, are product certifications issued after careful laboratory testing and ensure a low level of chemical emissions to indoor environments by GreenGuard classified products. In enclosed spaces, the air is 2 to 5 times more polluted than outside air, and pollutants come from products and materials that are used every day. The air quality of indoor environments becomes a significant issue when people spend most of their time indoors. GreenGuard certified seating ensures a low level of chemical emissions and therefore, a better air quality than the environments where they are used.

GreenGuard Gold Certification seating ensures the total absence of emissions of chemical substances, making these products an even safer choice for public environments, such as schools and healthcare facilities. GreenGuard certified products contribute to the acquisition of credits for the main green building protocols: LEED-2009, LEED-v4 (area "Indoor Environmental Quality"), California-CHPS, Australian Green Star, ASHRAE 189.1 and Green Guide for Health Care 2.2.

### Standard UNI EN ISO 354:2003

The standard defines a method for measuring the sound absorption coefficient in a reverberation chamber of wall or sound absorbing materials or the equivalent absorption area of furniture, people or absorbing surfaces. It is not to be used for the measurement of absorption characteristics. The values obtained can be used for comparison and design calculation for the purposes of noise control and the acoustic characteristics of the room.

### Key to symbols

 Two-tone coating

 Packaging dimensions

 Net weight

 Gross weight

 Number of packages

 Metres COM coating H/140 cm

 Product to be assembled



# Tessuti / Fabrics / Gewebe / Tissus / Tejidos

AL  
FiDiVi, Alba

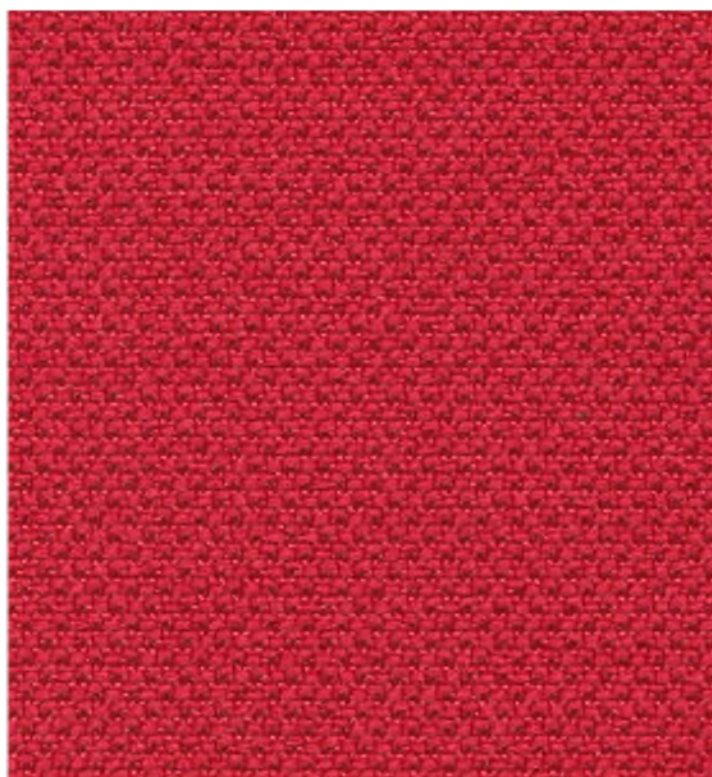

AL07\_Alba 4027



AL01\_Alba 8033



AL02\_Alba 8003



AL03\_Alba 8078

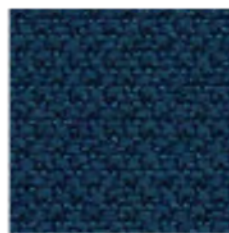

AL05\_Alba 6098

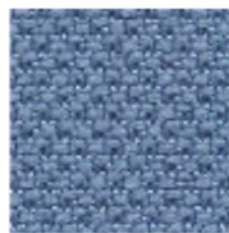

AL21\_Alba 6005



AL09\_Alba 6007

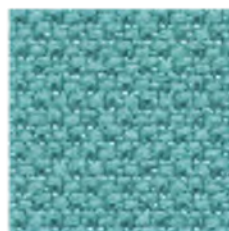

AL36\_Alba 7026

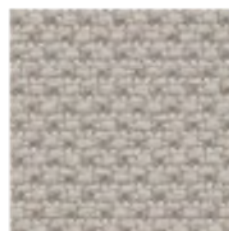

AL19\_Alba 1006

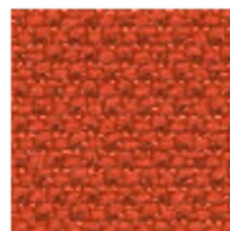

AL13\_Alba 4004



AL07\_Alba 4027

sitland

30% Rabatt skall dras av angivna priser



# Tessuti / Fabrics / Gewebe / Tissus / Tejidos

BN  
FiDiVi, Bondai



BN07\_Bondai 7048



BN01\_Bondai 8033



BN04\_Bondai 8030



BN18\_Bondai 8078



BN00\_Bondai 6098

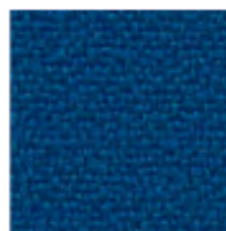

BN02\_Bondai 6036

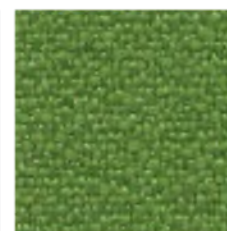

BN17\_Bondai 7048



BN12\_Bondai 7021



BN20\_Bondai 1008

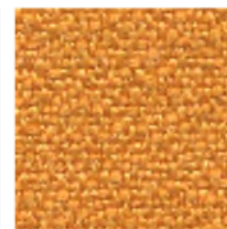

BN24\_Bondai 3005

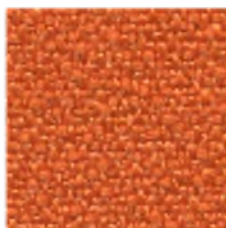

BN09\_Bondai 3012



BN05\_Bondai 4011

sitland

30% Rabatt skall dras av angivna priser



# Pelli ed ecopelli / Leathers and faux leather / Leder und Kunstleder / Cuir et faux cuir / Cueros y imitación de cuero

NX  
Lederplast

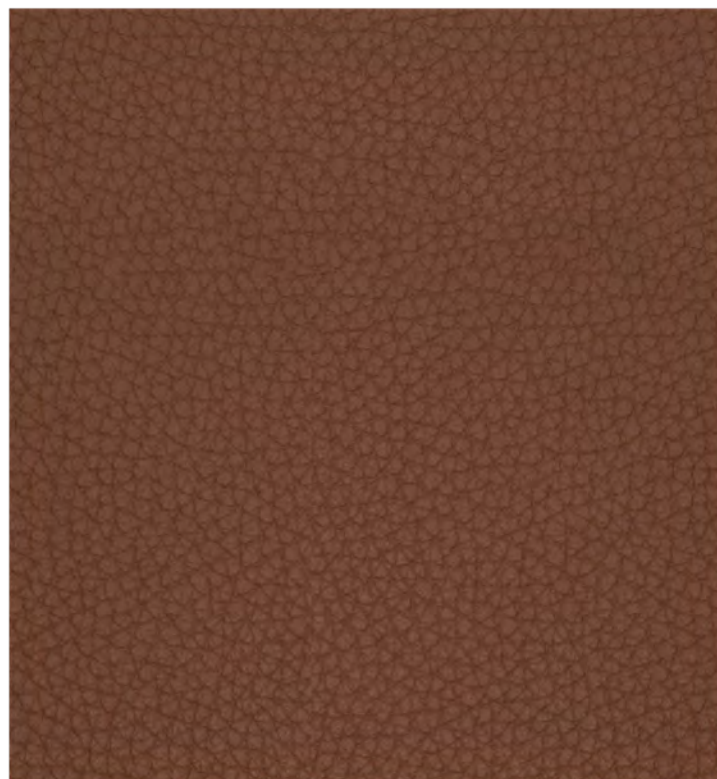

NX09



NX07



NX02

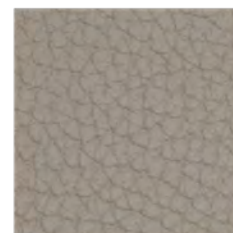

NX05

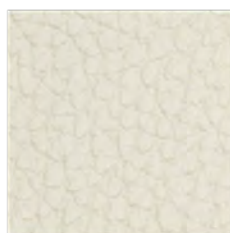

NX01

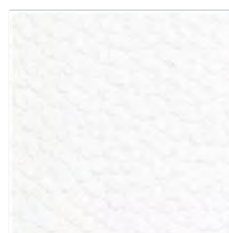

NX03

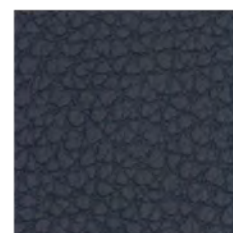

NX14

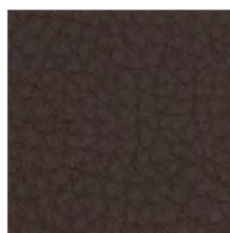

NX10



NX08



NX06

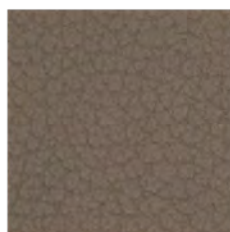

NX04

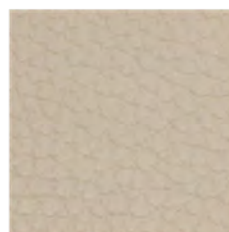

NX06

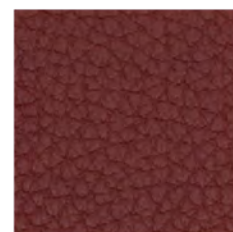

NX11

**sitland**

30% Rabatt skall dras av angivna priser



# Tessuti / Fabrics / Gewebe / Tissus / Tejidos

ME  
Gabriel, Medley



ME13\_Medley 68005



ME01\_Medley 60999



ME02\_Medley 60004



ME03\_Medley 60003



ME09\_Medley 66030

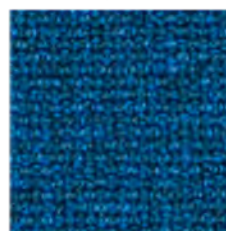

ME15\_Medley 66007

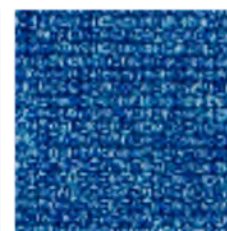

ME08\_Medley 66009



ME16\_Medley 66008



ME13\_Medley 68005



ME11\_Medley 68002



ME04\_Medley 61002



ME07\_Medley 65011

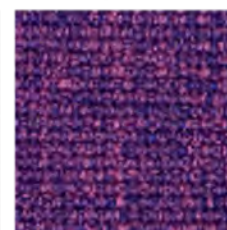

ME17\_Medley 65012



ME18\_Medley 64019

sitland

30% Rabatt skall dras av angivna priser



# Tessuti / Fabrics / Gewebe / Tissus / Tejidos

AB  
Camira, Xtreme Plus

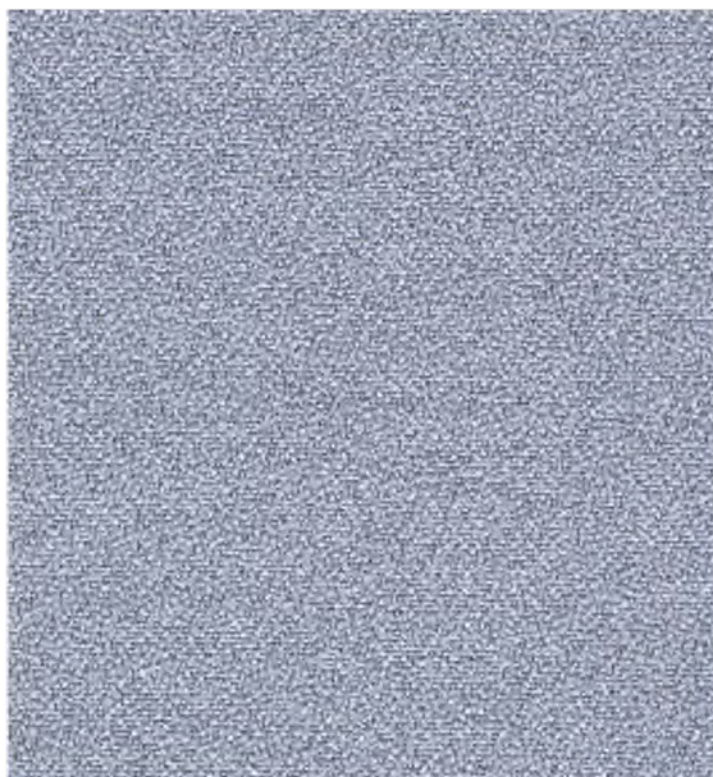

AB47\_Xtreme YS173



AB03\_Xtreme YS009



AB51\_Xtreme YS172



AB38\_Xtreme YS046



AB12\_Xtreme YS081



AB47\_Xtreme YS173



AB04\_Xtreme YS082

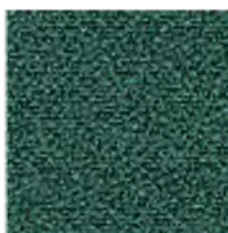

AB40\_Xtreme YS047



AB25\_Xtreme YS096



AB17\_Xtreme YS308



AB34\_Xtreme YS091

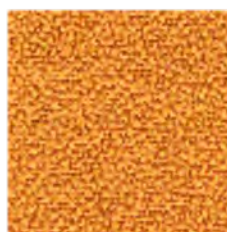

AB37\_Xtreme YS072



AB15\_Xtreme YS079



AB21\_Xtreme YS302

# sitland

30% Rabatt skall dras av angivna priser



# Reti / Meshes / Maschen / Mailles / Mallas

RF  
FiDiVi Service, Polo

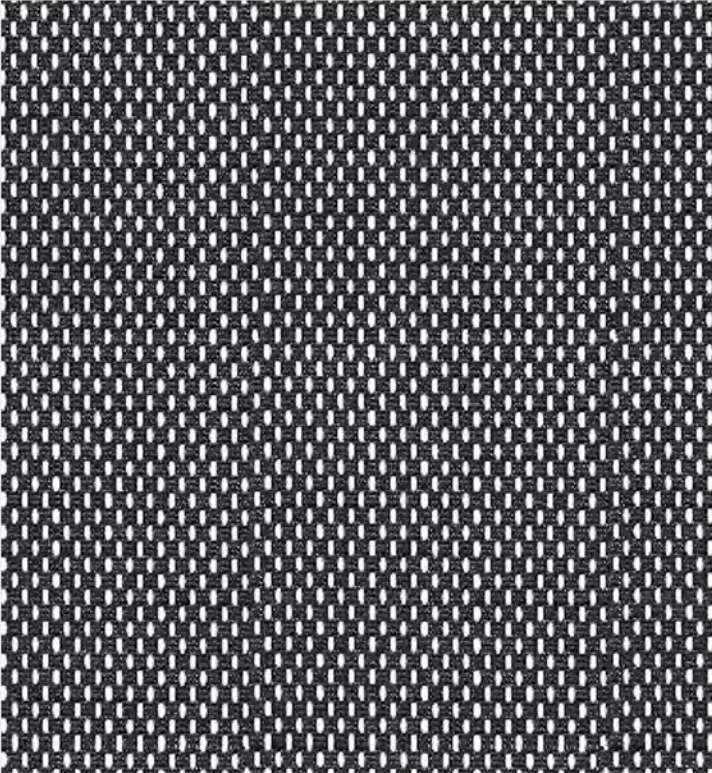

RF01

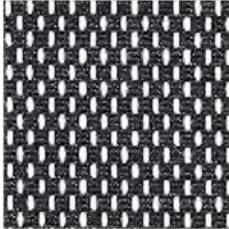

RF01

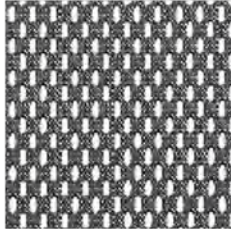

RF04



R702



RF05



RF03



# Tessuti / Fabrics / Gewebe / Tissus / Tejidos

CH  
Gabriel, Chili

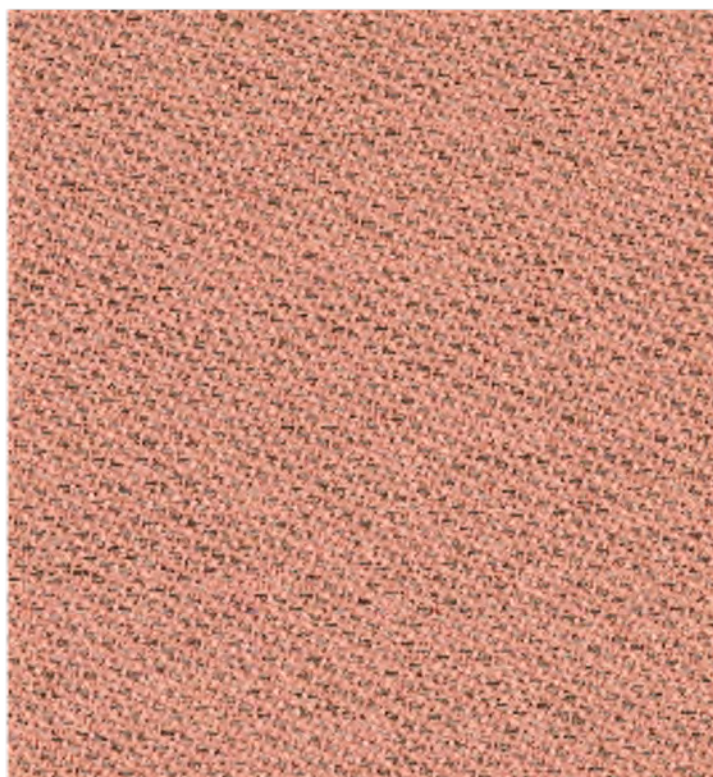

CH22\_Chil 63092



CH13\_Chil 60999



CH14\_Chil 61171



CH15\_Chil 61174

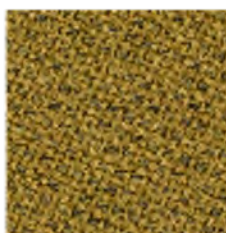

CH17\_Chil 68198



CH16\_Chil 61172

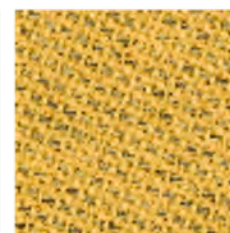

CH25\_Chil 62086

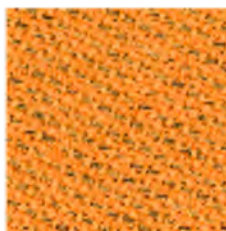

CH24\_Chil 63093

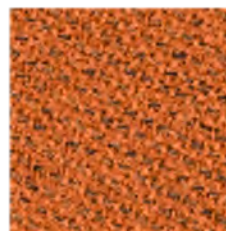

CH23\_Chil 63099



CH21\_Chil 64203



CH19\_Chil 65110

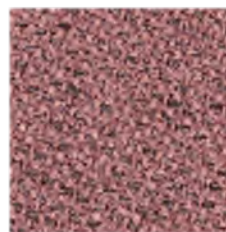

CH20\_Chil 65111



CH22\_Chil 63092



CH18\_Chil 68191

sitland

30% Rabatt skall dras av angivna priser





# Reti / Meshes / Maschen / Mailles / Mallas

RR  
Gabriel, Runner

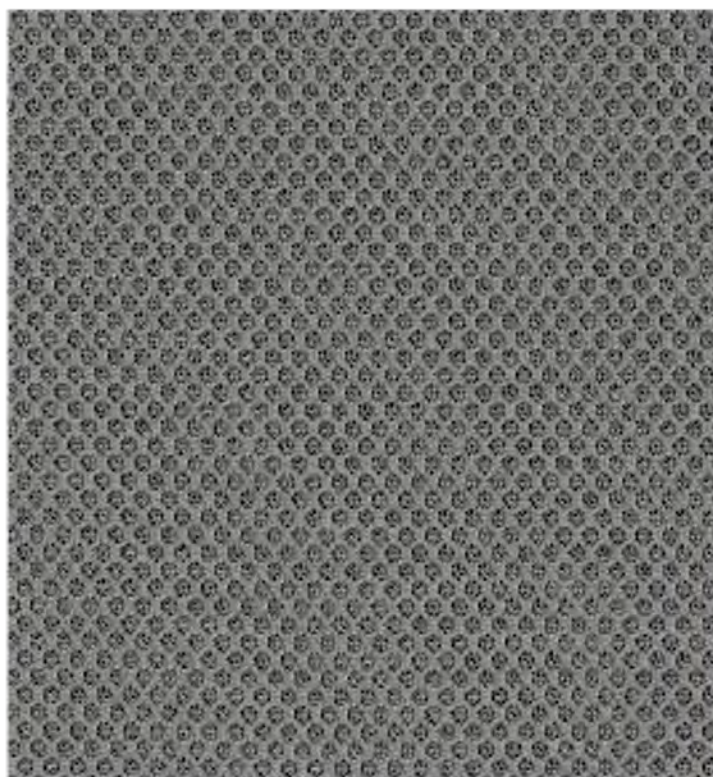

RR03\_Runner 60011



RR01\_Runner 60999



RR02\_Runner 60025



RR03\_Runner 60011



RR14\_Runner 60165



RR08\_Runner 66064



RR12\_Runner 66140



RR09\_Runner 65078



RR15\_Runner 66063



RR05\_Runner 68056



RR13\_Runner 61110



RR06\_Runner 63034



RR07\_Runner 64089

sitland

30% Rabatt skall dras av angivna priser



# Reti / Meshes / Maschen / Mailles / Mallas

RP  
Plastitex. Net Medium

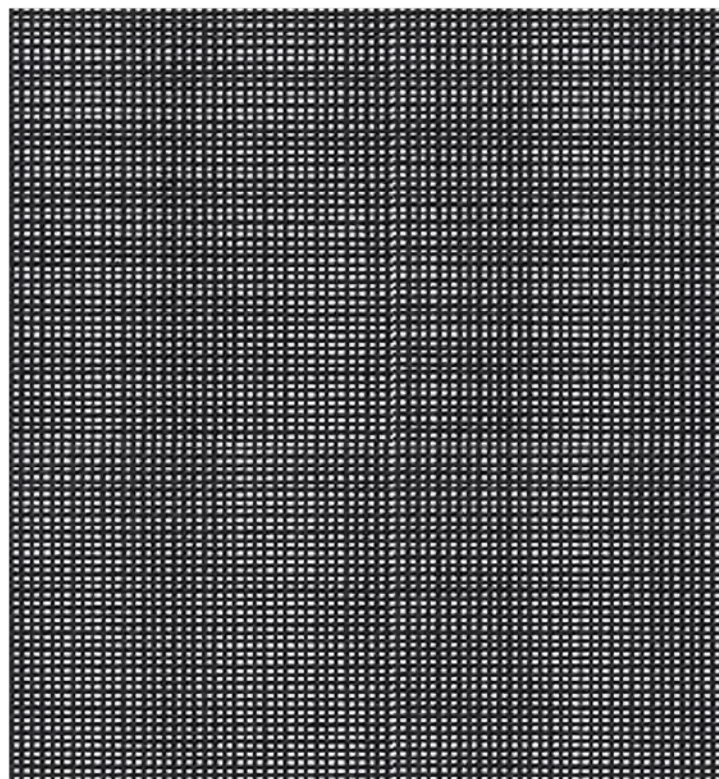

RP10

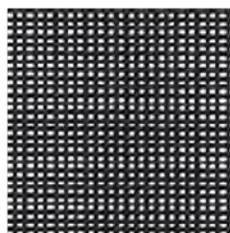

RP16

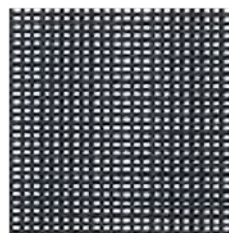

RP17

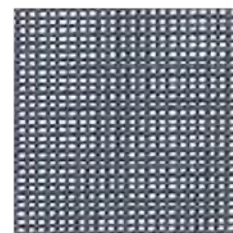

RP18

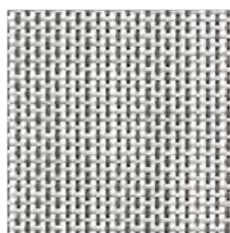

RP21

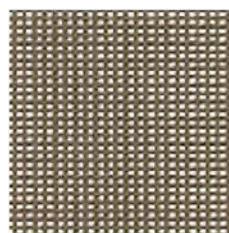

RP20

sitland

30% Rabatt skall dras av angivna priser



# Reti / Meshes / Maschen / Mailles / Mallas

**RY**  
**Gabriel, Rhythm**



RY03\_Rhythm 60165



RY01\_Rhythm 60999



RY02\_Rhythm 60025



RY03\_Rhythm 60165



RY09\_Rhythm 66152

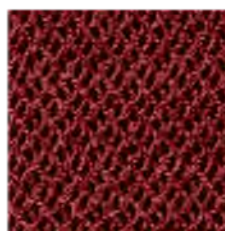

RY06\_Rhythm 63068

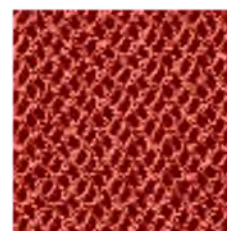

RY12\_Rhythm 63067

**sitland**

30% Rabatt skall dras av angivna priser



# Tessuti / Fabrics / Gewebe / Tissus / Tejidos

ST  
Gabriel, Step

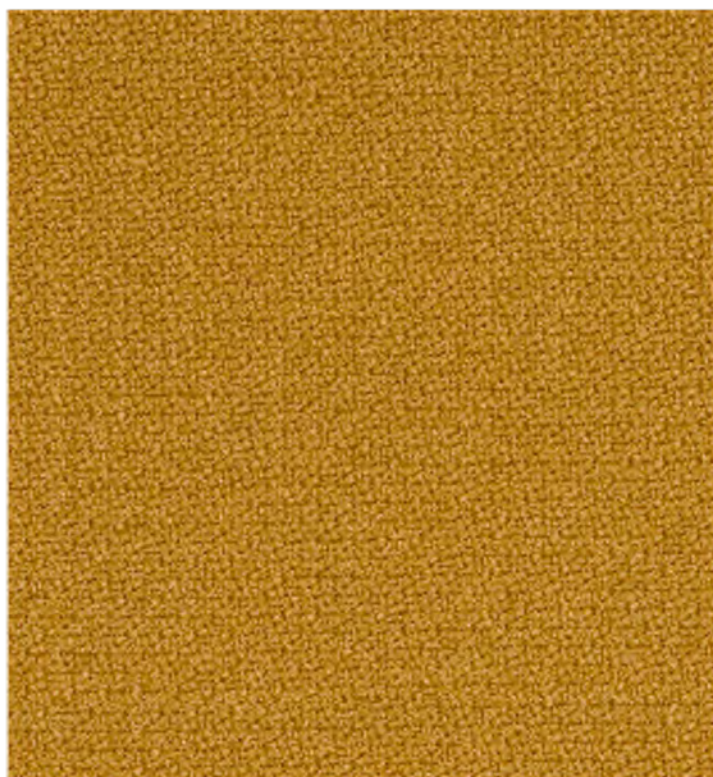

ST08\_Step 62057



ST01\_Step 60999



ST03\_Step 60021



ST04\_Step 60011



ST09\_Step 60004



ST31\_Step 66152



ST30\_Step 67004



ST32\_Step 68161



ST12\_Step 68120



ST29\_Step 61103



ST11\_Step 61149



ST08\_Step 62057



ST28\_Step 63075

sitland

30% Rabatt skall dras av angivna priser



# Pelli ed ecopelli / Leathers and faux leather / Leder und Kunstleder / Cuir et faux cuir / Cueros y imitación de cuero

SC  
Flukso, Secret



SC18\_Secret 1018



SC17\_Secret 1017



SC24\_Secret 1024



SC36\_Secret 1036



SC01\_Secret 1001

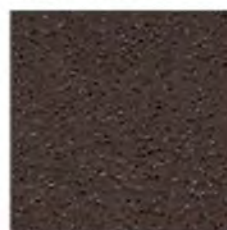

SC06\_Secret 1006



SC26\_Secret 1026



SC18\_Secret 1018



SC25\_Secret 1025



SC31\_Secret 1031



SC33\_Secret 1033



SC08\_Secret 1008



SC19\_Secret 1019

**RG**  
**Camira, Regent**

Cat. 4

100% PL Fr  
50.000 Martindale



RG19\_Regent REG19



RG26\_Regent REG26



RG23\_Regent REG23

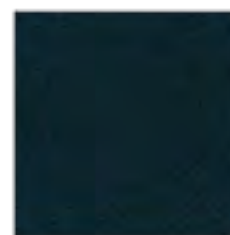

RG22\_Regent REG22



RG25\_Regent REG25



RG15\_Regent REG15



RG11\_Regent REG11



RG10\_Regent REG10



RG07\_Regent REG07



RG05\_Regent REG05



**MW/MF**  
**Camira, Main Line Twist/Main Line Flax**

Cat. 4

75% Virgin Wool, 25% Flax  
50.000 Martindale



MW12\_Main Line Twist MLT12



MF61\_Main Line Flax MLF61



MF26\_Main Line Flax MLF26



MF28\_Main Line Flax MLF28



MF66\_Main Line Flax MLF66



MW14\_Main Line Twist MLT14



MW02\_Main Line Twist MLT02



MF65\_Main Line Flax MLF65



MF17\_Main Line Flax MLF17



MW01\_Main Line Twist MLT01



MW10\_Main Line Twist MLT10



MF59\_Main Line Flax MLF59



MW03\_Main Line Twist MLT03



WF06\_Main Line Flax MLF06



MW04\_Main Line Twist MLT04



MF61\_Main Line Flax MLF61



MF50\_Main Line Flax MLF50

# Tessuti / Fabrics / Gewebe / Tissus / Tejidos

CS  
Gabriel, Crisp



CS08\_Crisp 04033



CS38\_Crisp 04013



CS40\_Crisp 04022



CS08\_Crisp 04033



CS04\_Crisp 04604



CS03\_Crisp 04034



CS35\_Crisp 04572



CS23\_Crisp 04603



CS05\_Crisp 04115



CS07\_Crisp 04032



CS37\_Crisp 04771



CS27\_Crisp 04711



CS05\_Crisp 04301

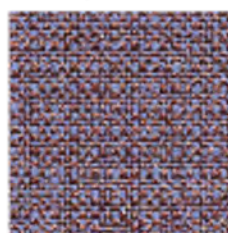

CS26\_Crisp 04702

sitland

30% Rabatt skall dras av angivna priser





# Tessuti / Fabrics / Gewebe / Tissus / Tejidos

SY  
Camira, Synergy

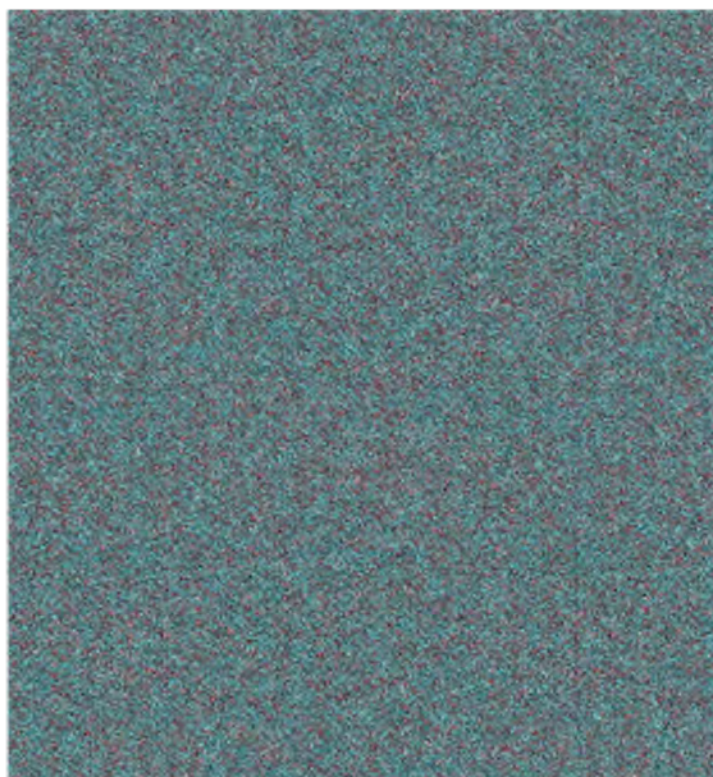

SY09\_Synergy LDS56



SY01\_Synergy LDS27



SY05\_Synergy LDS17

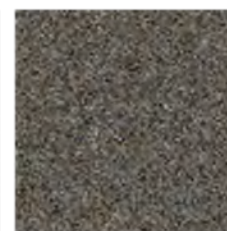

SY04\_Synergy LDS35



SY02\_Synergy LDS08



SY07\_Synergy LDS58

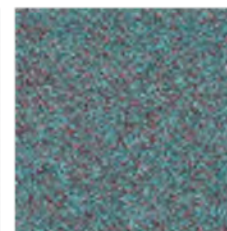

SY09\_Synergy LDS56



SY40\_Synergy LDS54



SY16\_Synergy LDS32

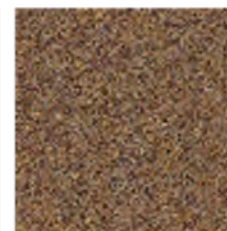

SY46\_Synergy LDS37



SY10\_Synergy LDS83



SY13\_Synergy LDS84

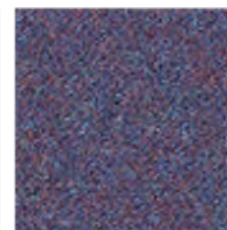

SY32\_Synergy LDS64

# sitland

30% Rabatt skall dras av angivna priser



**FT**  
**Vescom, Foster**

Cat. 9

97% recycled polyester  
FR / 3% polyester FR  
60.000 Martindale



FT17\_Foster 7072.17



FT14\_Foster 7072.14



FT09\_Foster 7072.09



FT13\_Foster 7072.13



FT02\_Foster 7072.02



FT01\_Foster 7072.01



FT12\_Foster 7072.12



# Tessuti / Fabrics / Gewebe / Tissus / Tejidos

**WI**  
**Vescom, Wilson**

80.000 Martindale  
100% Flame Retardant Polyester



W111\_Wilson 7067.10

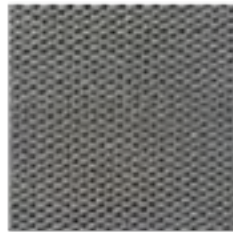

W110\_Wilson 7067.07



W107\_Wilson 7067.06



W108\_Wilson 7067.14



W109\_Wilson 7067.13

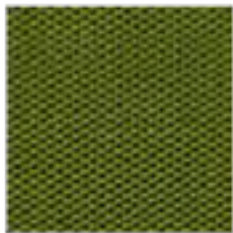

W104\_Wilson 7067.20

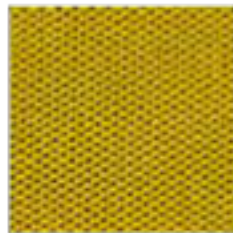

W103\_Wilson 7067.21



W105\_Wilson 7067.04

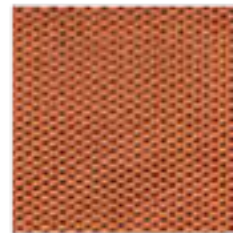

W101\_Wilson 7067.03



W106\_Wilson 7067.01

**sitland**

30% Rabatt skall dras av angivna priser

# Reti / Meshes / Maschen / Mailles / Mallas

IR  
FiDiVi Service, Iron

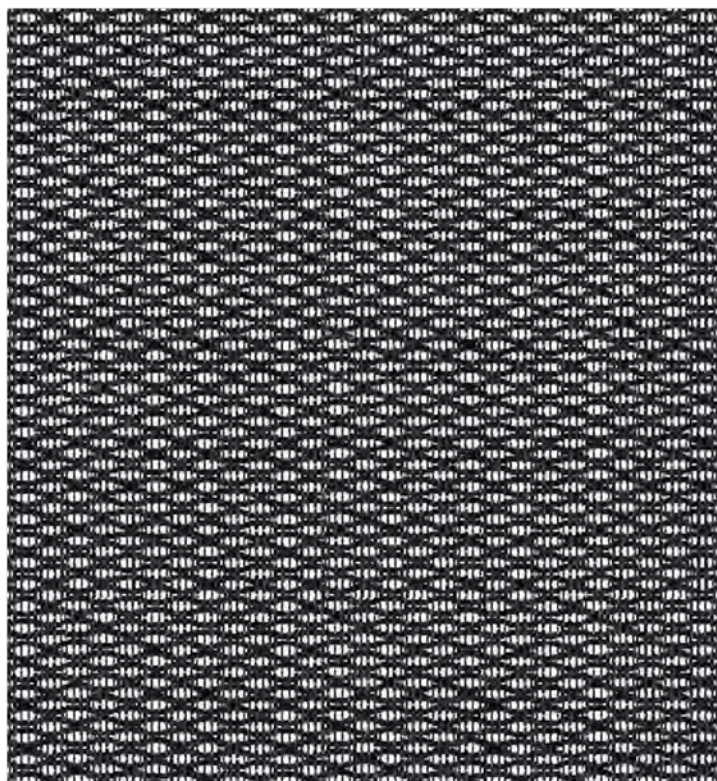

IR01

**sitland**

30% Rabatt skall dras av angivna priser

# Tessuti / Fabrics / Gewebe / Tissus / Tejidos

YO  
Camira, Yoredale



Y003\_Yoredale\_UA02



Y001\_Yoredale\_UA25



Y002\_Yoredale\_UA04



Y009\_Yoredale\_UA17



Y011\_Yoredale\_UA23

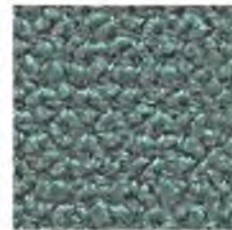

Y010\_Yoredale\_UA22



Y004\_Yoredale\_UA06



Y003\_Yoredale\_UA02



Y007\_Yoredale\_UA05



Y008\_Yoredale\_UA16



Y012\_Yoredale\_UA24



Y006\_Yoredale\_UA12



Y005\_Yoredale\_UA14

sitland

30% Rabatt skall dras av angivna priser

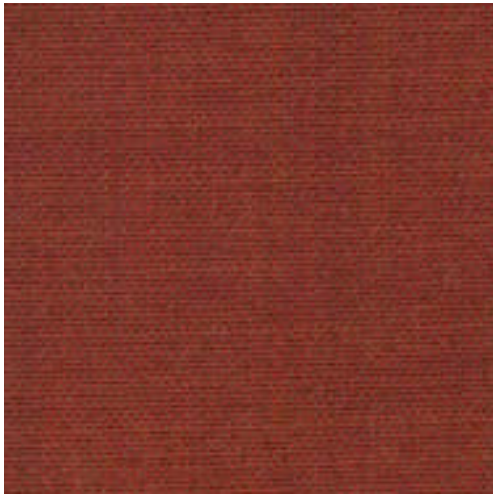

Remix 3 0653

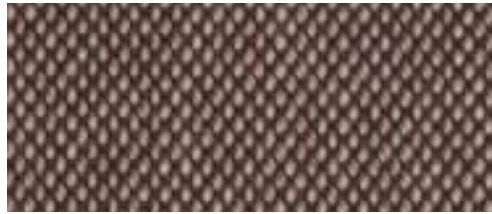

Steelcut Quartet 0354



Steelcut 3 0605

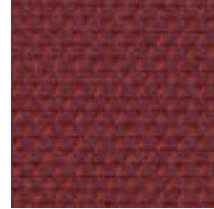

Steelcut Trio 3 0686

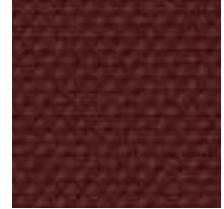

Steelcut 3 0682



Re-Wool 0558

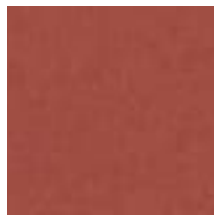

Hero 2 0542



Fiord 2 0571

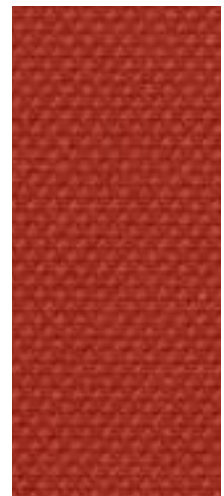

Steelcut 3 0562

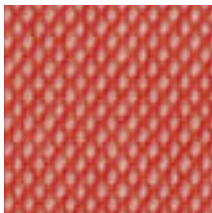

Steelcut Trio 3 0526



Remix 3 0516



Remix 3 0536

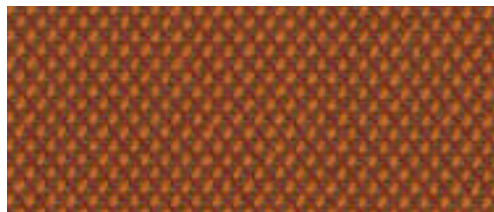

Steelcut Trio 3 0576

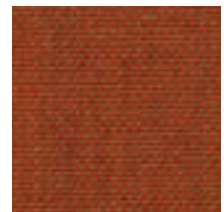

Remix 3 0443

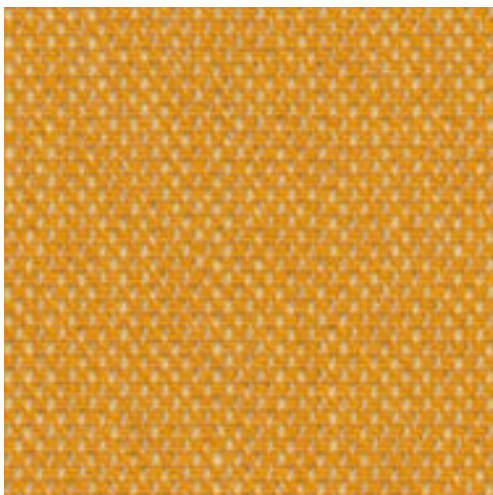

Steelcut Quartet 0434



Steelcut 3 0452



Steelcut Trio 3 0446

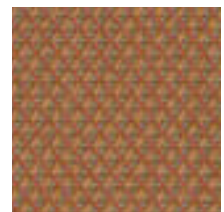

Steelcut trio 3 0436

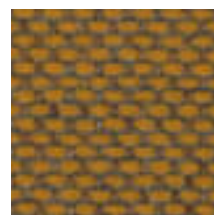

Re-Wool 0448

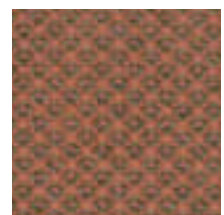

Fiord 2 0562





Re-Wool 0108



Remix 3 0133

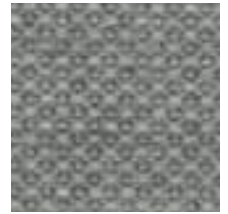

Fiord 2 0151



Steelcut 3 0140

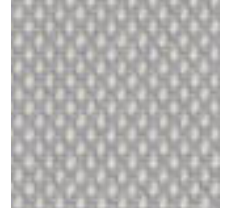

Steelcut Trio 3 0105

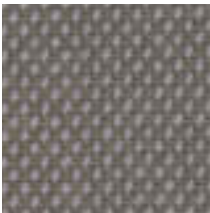

Steelcut Trio 3 0246



Steelcut 3 0155

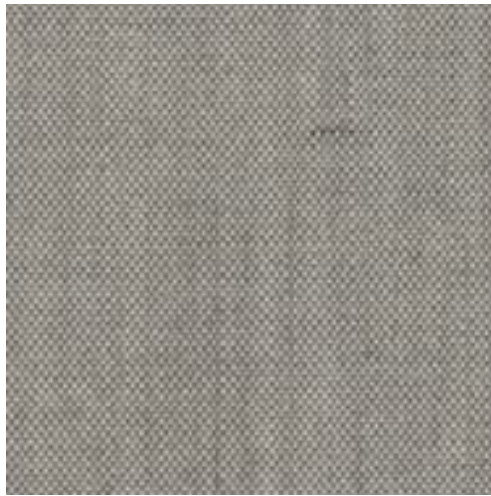

Remix 3 0126



Fiord 2 0101



Steelcut Trio 3 0113



Fiord 2 0251

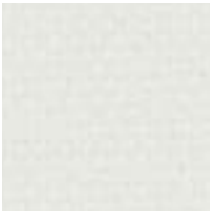

Steelcut 3 0110



Steelcut Trio 3 0906



Steelcut Trio 3 0236



Steelcut 3 0220



Steelcut Quartet 0114



Hero 2 0102



Fiord 2 0322

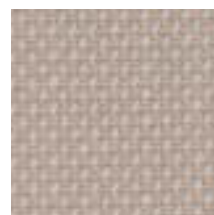

Steelcut Trio 3 0226



Steelcut Quartet 0414

30% Rabatt skall dras av angivna priser





Remix 3 0773



Fiord 2 0771

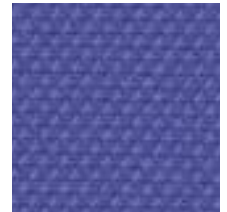

Steelcut 3 0652



Hero 2 0622

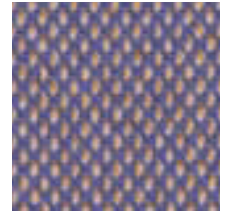

Steelcut Quartet 0644



Steelcut Trio 3 0796



Remix 3 0762



Steelcut Trio 3 0746



Remix 3 0866



Steelcut 3 0775



Hero 2 0752

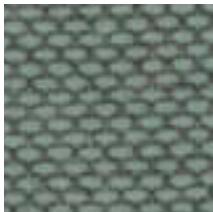

Re-Wool 0858

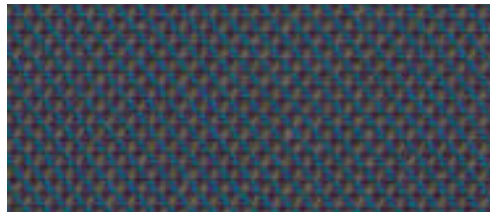

Steelcut Trio 3 0883



Hero 2 0772



Hero 2 0932

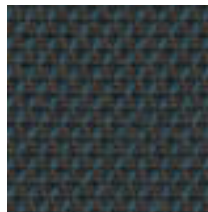

Steelcut Trio 3 0996



Steelcut 3 0932



Steelcut 3 0180



Remix 3 0982



Steelcut 3 0190

30% Rabatt skall dras av angivna priser





# Pelli ed ecopelli / Leathers and faux leather / Leder und Kunstleder / Cuir et faux cuir / Cueros y imitación de cuero

SX  
Dani, Box Land



SX05\_Box Land 7763



SX01\_Box Land 7150



SX02\_Box Land 7110



SX05\_Box Land 7763

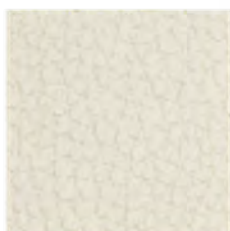

SX04\_Box Land 7200



SX03\_Box Land 7160

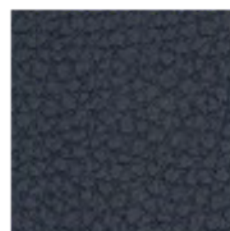

SX12\_Box Land 7190

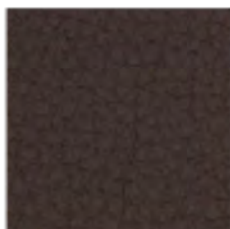

SX10\_Box Land 7270

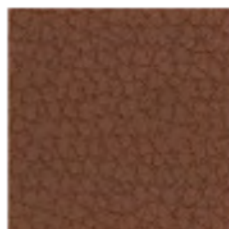

SX09\_Box Land 7748



SX08\_Box Land 7250

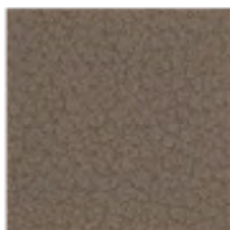

SX07\_Box Land 7799

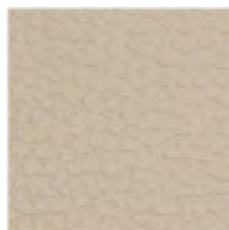

SX06\_Box Land 7734

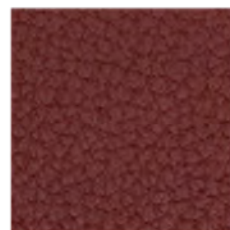

SX11\_Box Land 7170

sitland

30% Rabatt skall dras av angivna priser



# Pelli ed ecopelli / Leathers and faux leather / Leder und Kunstleder / Cuir et faux cuir / Cueros y imitación de cuero

PA  
Dani, Panama

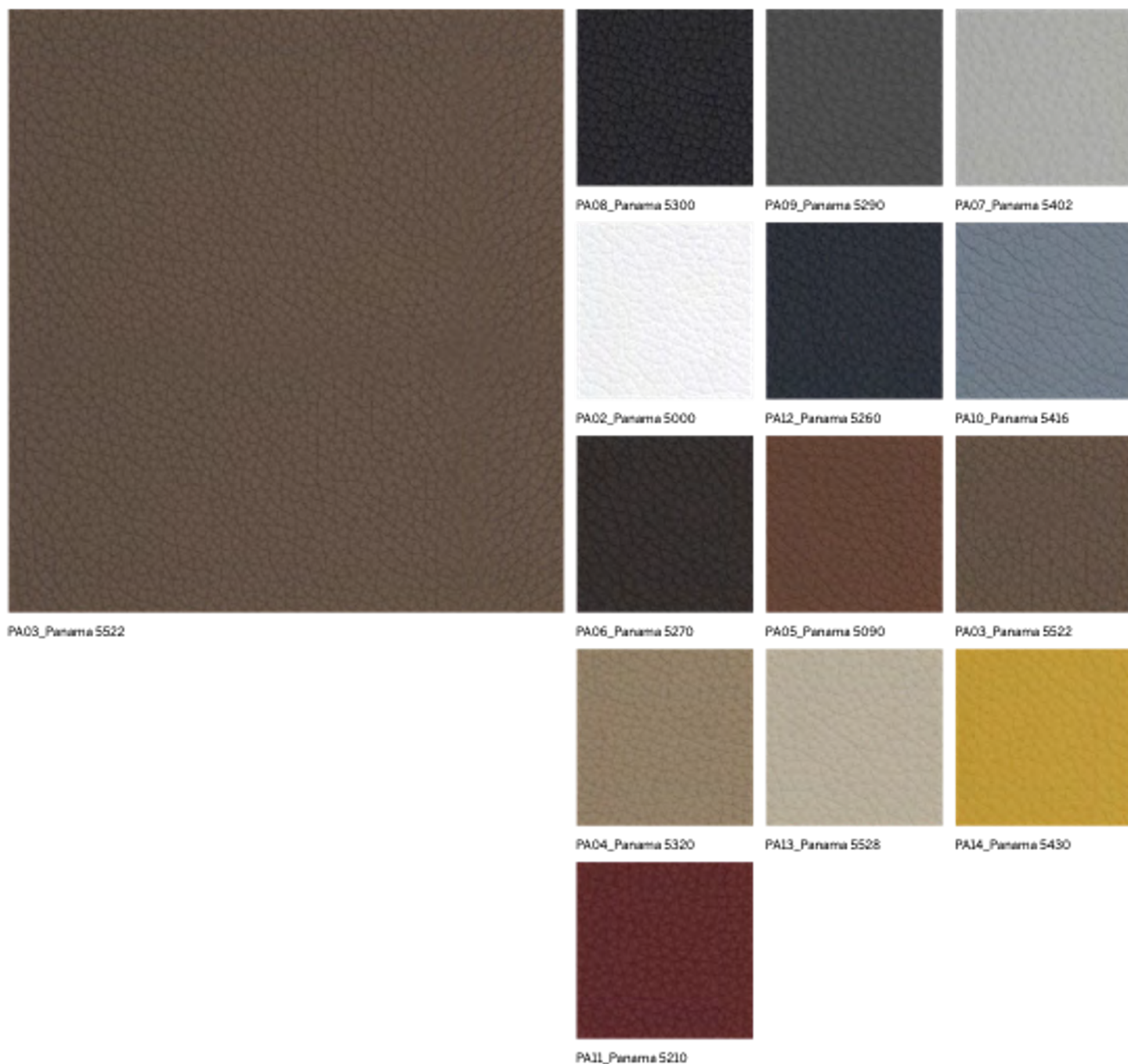

sitland

30% Rabatt skall dras av angivna priser



# Pelli ed ecopelli / Leathers and faux leather / Leder und Kunstleder / Cuir et faux cuir / Cueros y imitación de cuero

TS  
Dani, Florida



sitland

30% Rabatt skall dras av angivna priser



# AB Event Lindelöf.

---

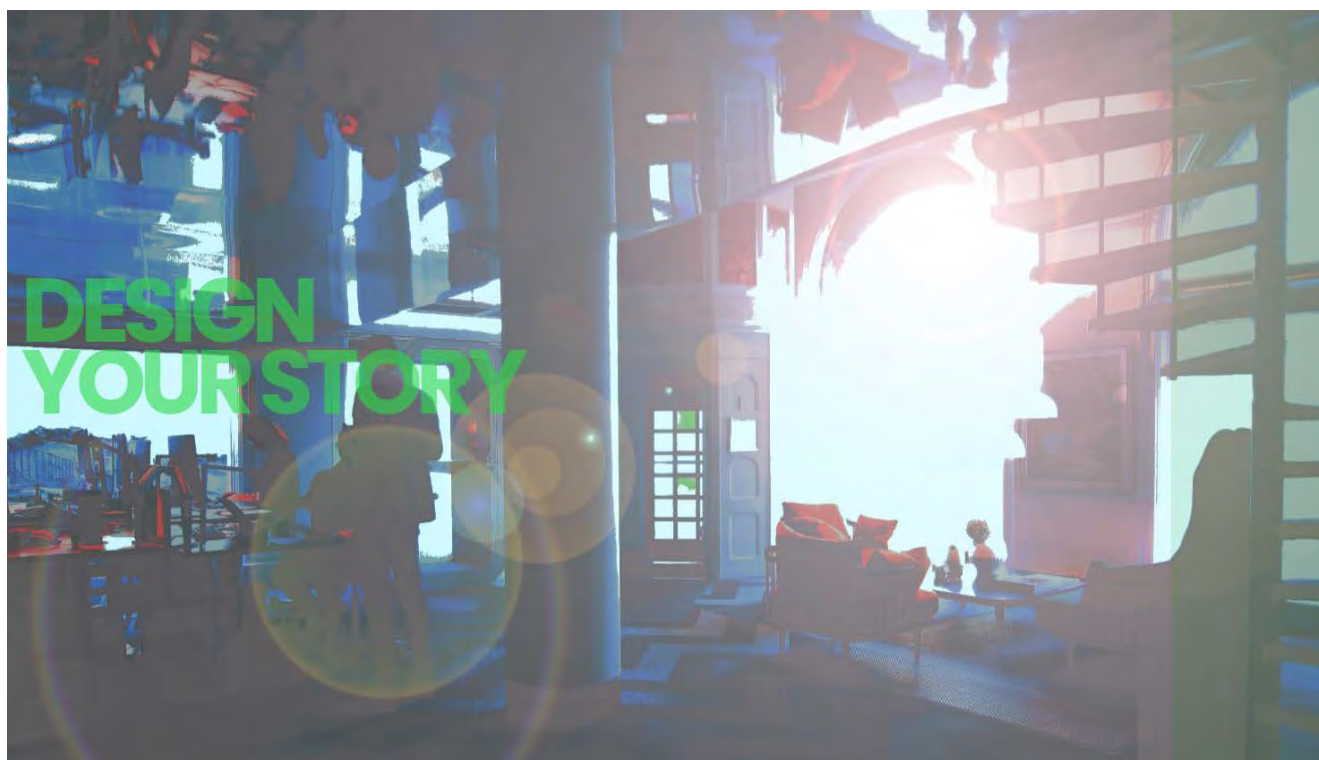

---

**Stockholm**  
Hornsgatan 29  
118 49 Stockholm

Tel. 08-442 70 00  
info.avtal@lindelof.se

**Östersund**  
Hornsgatan 29  
118 49 Stockholm

Tel. 08-442 70 00  
info.avtal@lindelof.se



30% Rabatt skall dras av angivna priser